



2007 Systems Engineering GA 3 Written examination

GENERAL COMMENTS

The 2007 Systems Engineering examination was based on all areas of study in Units 3 and 4 of the *Systems Engineering VCE Study Design*. The examination was based on the outcomes for Units 3 and 4 and the following criteria:

- knowledge of integrated mechanical and electrotechnological systems including the symbolic representation of controlled integrated systems
- knowledge of design, work plans, design options and evaluation criteria for controlled integrated systems
- understanding of the principles, operations and functions of controlled integrated systems
- evaluation of the effects on the environment of different energy sources used by technological systems.

Students were required to answer all questions.

The new study design allowed for a greater depth in understanding of the integration of mechanical and electrotechnological control systems. As advised in the examination specifications and advice issues during 2007, the examination did not contain any questions relating to the students' own work or to the work produced for their School-assessed Task.

About 60 per cent of the students gained approximately the same score for the mechanical questions as for the electrotechnological questions. What is of a concern is that about 40 per cent of students were clearly stronger in either the mechanical and electrotechnological subsystems. This was most evident in the responses to Section B Questions 1, 2 and 3, which should have been basic recall questions. Students who want to do well must be competent in all of the components of integrated control systems.

Students should look at the number of marks allocated to each question. If one mark is allocated, a simple, straightforward answer is all that is required. If two or more marks are allocated, answers need to show some working out or contain a description.

SPECIFIC INFORMATION

Section A – Multiple-choice questions

The table below indicates the percentage of students who chose each option. The correct answer is indicated by shading.

Question	% A	% B	% C	% D
1	10	87	2	2
2	15	24	28	33
3	6	11	10	74
4	35	34	20	11
5	31	8	13	47
6	44	8	46	2
7	6	72	17	5
8	4	9	14	73
9	2	25	4	69
10	12	42	18	28
11	25	13	14	48
12	5	77	10	7
13	8	16	15	61
14	30	52	3	15
15	47	5	11	37
16	1	2	92	5
17	9	56	17	19
18	35	14	36	15
19	6	7	59	27
20	85	4	2	9



Section B – Short answer questions

For each question, an outline answer (or answers) is provided. In some cases the answer given is not the only answer that could have been awarded marks.

Question 1

Marks	0	1	2	3	Average
%	41	24	21	15	1.1

logic gate	truth table
A	Truth Table 3
B	Truth Table 4
C	Truth Table 2
D	Truth Table 1

Many students did not seem to know the basics of Digital Electronics. These gates are the basis of most electromechanical systems, and students are expected to know how each gate works and also follow through the logic of combinations of these gates.

Question 2

Marks	0	1	2	3	4	Average
%	62	11	9	7	10	0.9



scissors

Shear

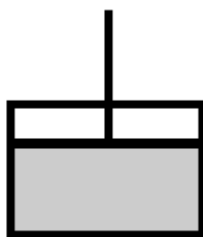

piston

Compression



spanner

Torsion



rope

Tension

This question was poorly done. Students are expected to understand the types of forces in common use.

Question 3

Marks	0	1	2	3	Average
%	59	16	3	22	0.9



wheel barrow

Class 2



crane

Class 3



seesaw

Class 1

The answers to this question were disappointing. Most students were unable to even have a guess at the class of lever in the diagrams. It is essential for students to have an understanding of these basic concepts.

2007 Assessment Report



Question 4

Marks	0	1	Average
%	73	27	0.3

The test results indicate that the diode in the circuit is working.

Question 5

Marks	0	1	2	3	Average
%	16	10	67	7	1.7

- A: only the light on the right would turn on and off.
- B: The circuit would operate correctly.
- C: The circuit would short circuit.

The answers to A and B were well done, but many students failed to see the short circuit in diagram C.

Question 6a.

Marks	0	1	2	Average
%	48	14	38	0.9

Acceptable answers included either of:

- converting rotary to linear motion
- as the cam rotates, the follower moves up then suddenly down.

Students who were familiar with a cam and follower had no difficulty with this question.

Question 6b.

Marks	0	1	Average
%	39	61	0.6

The cam moves anticlockwise.

Question 7a.

Marks	0	1	2	Average
%	5	23	73	1.7

Acceptable answers included any two of:

- burns to people and objects
- electrocution from bare wires
- breathing in fumes
- getting something in your eyes.

Safety practices within the classroom are an important part of the course. Any two reasonable risks were accepted here.

This question was well answered.

Question 7b.

Marks	0	1	Average
%	19	81	0.8

Acceptable responses included:

- use a soldering iron stand
- check the soldering iron for exposed wires
- work in a well ventilated area.

As long as the explanation related to a legitimate risk listed in part a. the mark for this question was awarded.

Question 8

Marks	0	1	2	3	Average
%	10	9	27	55	2.3

2007 Assessment Report

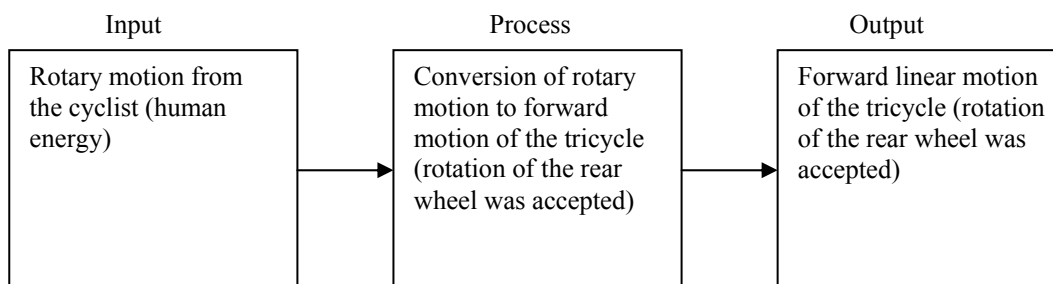

Question 9

Marks	0	1	2	Average
%	9	25	66	1.6

- Rotary: this occurred in the wheels and the pedals.
- Linear: this was in the motion of the tricycle itself. (The motion of the chain is complex and, as parts of its motion are linear, the chain was also accepted as a correct answer.)

Question 10

Marks	0	1	2	Average
%	13	19	69	1.6

60:15 = 4:1

1:4 was also accepted.

Question 11

Marks	0	1	2	Average
%	90	0	10	0.2

A ratio of 1:12 or 12:1 was accepted.

This question tested whether students knew to multiply the ratios of each set of gears. Students needed to show how they made their calculation, using a formula.

Question 12a.

Marks	0	1	Average
%	12	88	0.9

Acceptable answers included:

- in the tyres on the ground
- in the axels
- in the chain.

Question 12b.

Marks	0	1	Average
%	31	69	0.7

As long as this answer was correct in relation to the answer given in part a., a mark was awarded. 'Applying oil to the chain' when the friction of the tyres was given in part a. did not gain the mark.

Question 13a.

Marks	0	1	2	Average
%	24	17	60	1.4

Students needed to give a distance over which the tricycle would travel. The answer also had to include the process of measuring the length of time it would take the tricycle to travel the given distance. For example, measure out 40 metres then time how long it takes the tricycle to travel the 40 metres.

2007 Assessment Report



Question 13b.

Marks	0	1	Average 0.5
%	48	52	

The answer given in the previous part had to be used for part b. Students needed to use the formula

$$\text{time} = \frac{\text{distance}}{\text{velocity}}; \text{ for example, } \frac{40 \text{ m}}{20 \text{ m/s}} = 2 \text{ seconds.}$$

Question 14

Marks	0	1	2	3	Average 1.0
%	49	22	12	17	

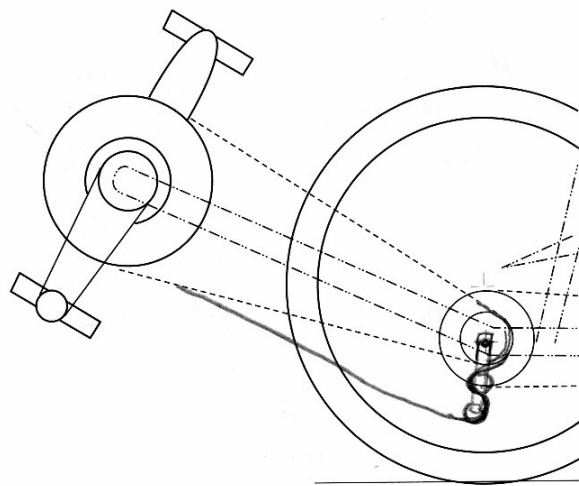

This is one of a number of possible answers. Any such chain tensioning system cannot be added to the bottom part of the chain. A self tension system drawn on the drive side of the chain gained a maximum of one mark.

Question 15

Marks	0	1	2	3	Average 1.6
%	9	38	39	14	

Some good answers were given. These answers demonstrated that environmental issues are important in the construction and disposal of systems. The term 'pollution' was not specific enough; however, specific terms such as 'noise pollution', 'air pollution', 'visual pollution', 'use of fossil fuels' and 'creation of carbon dioxide' were accepted.

Question 16

Marks	0	1	2	Average 1.0
%	46	14	40	

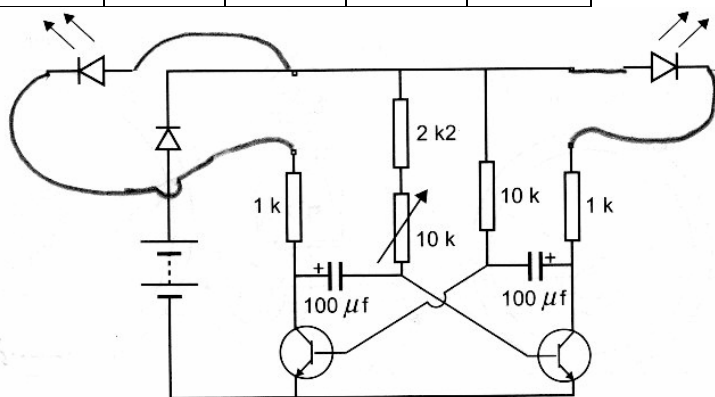

One mark was given for each LED correctly connected.

2007 Assessment Report



Question 17

Marks	0	1	2	3	Average
%	20	19	33	29	1.7

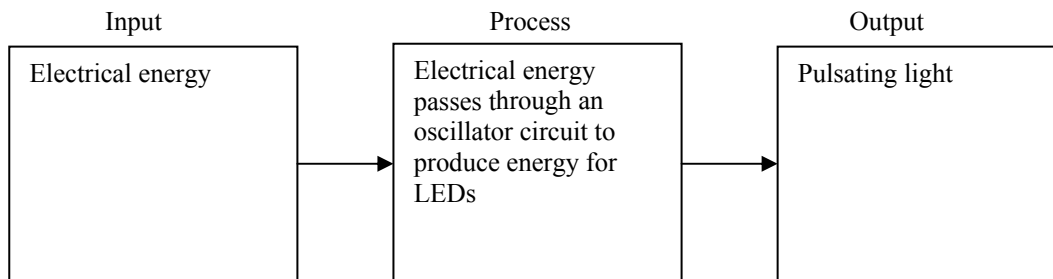

Question 18

Marks	0	1	2	3	Average
%	8	26	46	19	1.8

- i. Battery
- ii. Resistor
- iii. Electrolytic Capacitor

Question 19

Marks	0	1	2	Average
%	58	4	39	0.8

The diode is now reverse biased, hence the circuit will not operate.

Question 20

Marks	0	1	2	Average
%	30	55	15	0.9

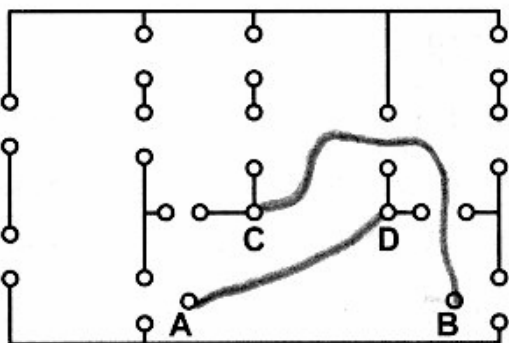

Having one wire correctly joined gained one mark. The second wire could not cross the first unless it was clear that there was an extra wire link. The second mark was not given to those who simply drew a second wire straight from B to C. Any wires drawn so that short circuits were created were not given marks.

Students need to be able to read and interpret circuit diagrams.

Question 21

Marks	0	1	2	Average
%	58	19	23	0.7

5 k Ω or 5200 Ω

30% of the 10 k is 3 k. This step was worth one mark. The second mark was given when 2 k Ω was added to the student's value for the first part of the question. 2 k Ω + 3 k = 5 k Ω or 5200 Ω .

2007 Assessment Report



Question 22

Marks	0	1	2	Average
%	48	8	44	1.0

The power dissipation of the transistor is not an issue in this circuit. A NPN transistor must be replaced with another NPN transistor, so it is not a suitable substitute.

Question 23

Marks	0	1	2	3	4	Average
%	12	18	26	22	22	2.3

- Definition 1: Integrated circuit
- Definition 2: Rectifier
- Definition 3: Voltage regulator
- Definition 4: Digital signals

Question 24

Marks	0	1	2	3	Average
%	26	17	23	34	1.7

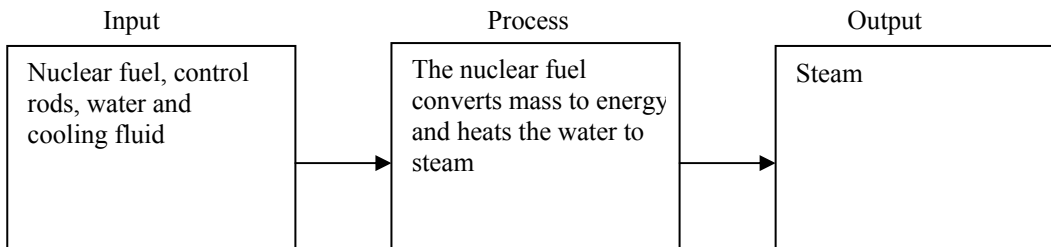

Some students gave the output of the power station and not just the reactor. As long as students showed an understanding of the process within the reactor, marks were awarded.

Students are expected to have a basic understanding of all of the alternate sources of energy listed in the study design.

Question 25

Marks	0	1	2	3	Average
%	55	17	15	14	0.9

Acceptable answers included any three of:

- nuclear energy to heat energy in the reactor
- heat converts water to steam (heat to kinetic energy)
- steam or kinetic energy to rotational energy in the turbine
- rotational to electric energy in the generator
- steam to water in the condenser.

Question 26a.

Marks	0	1	2	Average
%	40	39	21	0.8

Very little greenhouse gas is produced during the production of nuclear electricity.

Question 26b.

Marks	0	1	2	Average
%	34	35	31	1.0

The nuclear reactor produces radioactive by-products that need to be stored for many thousands of years.