



Victorian Certificate of Education

2007

SUPERVISOR TO ATTACH PROCESSING LABEL HERE

STUDENT NUMBER

Letter

Figures

Words

CHEMISTRY

Written examination 2

Thursday 15 November 2007

Reading time: 9.00 am to 9.15 am (15 minutes)

Writing time: 9.15 am to 10.45 am (1 hour 30 minutes)

QUESTION AND ANSWER BOOK

Structure of book

Section	Number of questions	Number of questions to be answered	Number of marks
A	20	20	20
B	8	8	64
			Total 84

- Students are permitted to bring into the examination room: pens, pencils, highlighters, erasers, sharpeners, rulers and one scientific calculator.
- Students are NOT permitted to bring into the examination room: blank sheets of paper and/or white out liquid/tape.

Materials supplied

- Question and answer book of 20 pages, with a detachable data sheet in the centrefold.
- Answer sheet for multiple-choice questions.

Instructions

- Detach the data sheet from the centre of this book during reading time.
- Write your **student number** in the space provided above on this page.
- Check that your **name** and **student number** as printed on your answer sheet for multiple-choice questions are correct, **and** sign your name in the space provided to verify this.
- All written responses must be in English.

At the end of the examination

- Place the answer sheet for multiple-choice questions inside the front cover of this book.

Students are NOT permitted to bring mobile phones and/or any other unauthorised electronic devices into the examination room.

SECTION A – Multiple-choice questions**Instructions for Section A**

Answer **all** questions in pencil on the answer sheet provided for multiple-choice questions.

Choose the response that is **correct** or that **best answers** the question.

A correct answer scores 1, an incorrect answer scores 0.

Marks will **not** be deducted for incorrect answers.

No marks will be given if more than one answer is completed for any question.

Question 1

In which one of the following compounds does the transition metal display the lowest oxidation state?

- A. CrO₃
- B. Cu₂S
- C. MnCl₂
- D. K₂Cr₂O₇

Question 2

Consider the following nuclear reaction that takes place in stars.

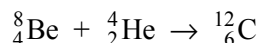

Which of the following statements about this change is/are **correct**?

- I The reaction is endothermic.
 - II The mass of the ${}^{12}_6\text{C}$ nucleus is greater than the combined masses of the reactants.
- A. I only
 - B. II only
 - C. both I and II
 - D. neither I nor II

Question 3

Some information about the element rhenium (Re) is given in the table below.

Isotope	Relative isotopic mass
${}^{185}\text{Re}$	185.0
${}^{187}\text{Re}$	187.0

Given that the relative atomic mass of Re is 186.2, the percentage abundance of ${}^{187}\text{Re}$ is closest to

- A. 40
- B. 50
- C. 60
- D. 70

Question 4

A solution prepared by stirring $\text{Na}_2\text{O}(\text{s})$ in water undergoes an acid-base reaction with a solution prepared from $\text{SO}_3(\text{g})$ and water.

Which one of the following salts could be isolated from the reaction mixture?

- A. Na_2S
- B. NaHSO_3
- C. Na_2SO_3
- D. Na_2SO_4

Question 5

Which one of the following alternatives contains molecules and ions that are **all** likely to form a complex ion with a transition metal cation?

- A. Cl^- , F^- , CN^- , H^+
- B. NH_3 , Cl^- , F^- , H_2O
- C. Na^+ , CN^- , F^- , H_2O
- D. CH_4 , Cl^- , NH_3 , H_2O

Question 6

Predict which one of the following compounds would be coloured.

- A. BaSO_4
- B. AlPO_4
- C. KClO_4
- D. NaMnO_4

Question 7

Which of the following statements about enzymes are correct?

- I Enzymes are proteins.
- II Enzymes increase the rate of biochemical reactions.
- III Enzymes increase the equilibrium constant of biochemical reactions.

- A. I and II only
- B. I and III only
- C. II and III only
- D. I, II and III

Question 8

A structure of vitamin C is given below.

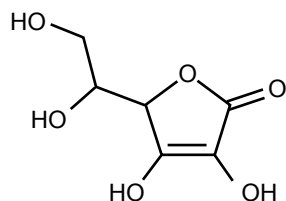

Vitamin C is an important biological molecule. It is often added to foods as an antioxidant.

Based on this information, and on the structure of vitamin C shown above, it can be predicted that vitamin C is more soluble in

- A. fats than in water and is a good oxidant.
- B. fats than in water and is a good reductant.
- C. water than in fats and is a good oxidant.
- D. water than in fats and is a good reductant.

Question 9

The types of compounds that comprise the major food groups include carbohydrates, fats and proteins. A sample, containing only one of these three types of compounds, is analysed and found to contain the following percentages by mass.

Carbon	76.2%
Oxygen	11.3%
Nitrogen	0%

The compound

- A. is likely to be a fat.
- B. is likely to be a protein.
- C. is likely to be a carbohydrate.
- D. cannot be identified as the percentage composition of other elements has not been given.

Question 10

The following two unbalanced equations represent processes which are part of the nitrogen cycle.

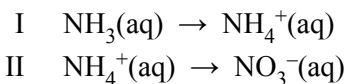

Which one of the following alternatives correctly describes the reactants in each of these processes?

In process I, $\text{NH}_3(\text{aq})$ is	In process II, the $\text{NH}_4^+(\text{aq})$ ion is
A. an acid	reduced
B. a base	reduced
C. an acid	oxidised
D. a base	oxidised

Question 11

Consider the following half cells which are set up under standard conditions.

half cell	electrode	electrolyte
I	metal A	$A^{2+}(aq)$
II	platinum	$B^{2+}(aq)$ and $B^{3+}(aq)$
III	metal C	$C^{+}(aq)$

- When a galvanic cell is constructed from half cell I and half cell II, the electrode in half cell II is negative.
- When a galvanic cell is constructed from half cell II and half cell III, the electrode in half cell III is negative.

The strongest oxidant is

- A. $A^{2+}(aq)$
- B. $B^{2+}(aq)$
- C. $B^{3+}(aq)$
- D. $C^{+}(aq)$

Questions 12, 13 and 14 refer to the following information.

The diagram below represents a diaphragm cell used for the commercial production of chlorine gas.

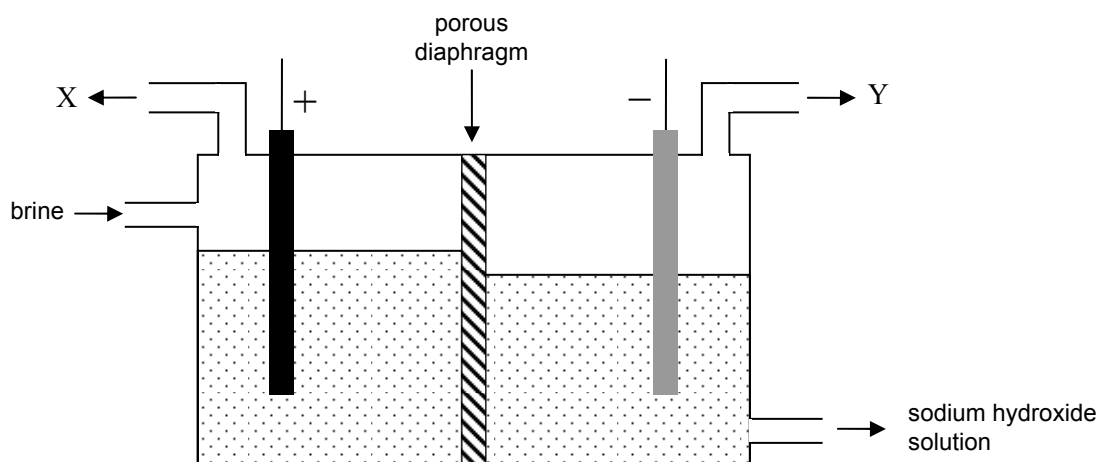

Question 12

The gases labelled X and Y are

- | X | Y |
|-------------|----------|
| A. chlorine | oxygen |
| B. oxygen | chlorine |
| C. chlorine | hydrogen |
| D. hydrogen | chlorine |

Question 13

One function of the porous diaphragm in the cell is to

- act as a catalyst to increase the rate of the reaction.
- allow movement of ions between the cell compartments.
- prevent sodium ions from entering the solution near the anode.
- prevent the electrolyte from making contact with the gases produced.

Question 14

A highly concentrated salt solution, called brine, is used as the electrolyte in this cell.

The main reason that a highly concentrated, rather than a dilute, solution is used is in order to

- allow an electric current to pass through the cell.
- produce chlorine gas, in preference to oxygen gas.
- allow sodium hydroxide to be separated from the salt by crystallisation.
- create non-standard conditions that ensure hydrogen gas production.

Questions 15 and 16 refer to the following information.

A rechargeable cell, used in laptop computers, contains a metal alloy (designated M) which has hydrogen atoms adsorbed on its surface, and nickel in the form of NiO(OH)(s) and Ni(OH)₂(s).

The half reactions, written as reduction reactions, are

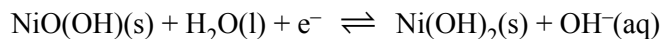
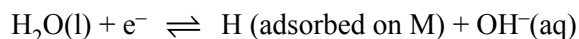

While this cell is generating electricity, the metal alloy acts as the negative electrode.

Question 15

When this cell is generating electricity

- A. NiO(OH) acts as the oxidant.
- B. the concentration of OH⁻ ions in the cell increases as the cell discharges.
- C. OH⁻ ions produced at the negative electrode migrate to the positive electrode.
- D. electrons flow in the external circuit from the positive to the negative electrode.

Question 16

When the cell is recharged, which one of the following processes occurs at the electrode connected to the **positive** terminal of the external power source?

- A. reduction of H₂O(l)
- B. reduction of NiO(OH)(s)
- C. oxidation of Ni(OH)₂(s)
- D. oxidation of H (adsorbed on M)

Question 17

A fuel cell currently under development for powering small electronic devices is based on the reaction of methanol and oxygen using an acidic electrolyte.

The reductant in the cell reaction and the half reaction at the anode are

reductant	anode reaction
A. methanol	$\text{O}_2(\text{g}) + 4\text{H}^+(\text{aq}) + 4\text{e}^- \rightarrow 2\text{H}_2\text{O}(\text{l})$
B. oxygen	$\text{O}_2(\text{g}) + 4\text{H}^+(\text{aq}) + 4\text{e}^- \rightarrow 2\text{H}_2\text{O}(\text{l})$
C. methanol	$\text{CH}_3\text{OH}(\text{g}) + \text{H}_2\text{O}(\text{l}) \rightarrow \text{CO}_2(\text{g}) + 6\text{H}^+(\text{aq}) + 6\text{e}^-$
D. oxygen	$\text{CH}_3\text{OH}(\text{g}) + \text{H}_2\text{O}(\text{l}) \rightarrow \text{CO}_2(\text{g}) + 6\text{H}^+(\text{aq}) + 6\text{e}^-$

Questions 18 and 19 refer to the following information.

A chemist used bomb calorimetry to measure the enthalpy change (ΔH) for the combustion of butane.

Question 18

The calibration factor (CF) of the calorimeter was determined by measuring the temperature rise (ΔT_1) that occurred when a known amount of charge (Q) was passed through the heating element in the calorimeter at a measured voltage (V).

The CF, in $\text{J}^\circ\text{C}^{-1}$, is

- A. $\frac{Q}{V \times \Delta T_1}$
- B. $\frac{\Delta T_1}{Q \times V}$
- C. $V \times Q \times \Delta T_1$
- D. $\frac{V \times Q}{\Delta T_1}$

Question 19

In the calorimeter (calibration factor, CF), n mol of butane was then burnt and the resulting temperature rise (ΔT_2) was measured.

The ΔH , in J mol^{-1} , for the reaction

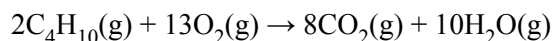

is

- A. $2 \times \text{CF} \times \Delta T_2 \times n$
- B. $\frac{2 \times \text{CF} \times \Delta T_2}{n}$
- C. $\frac{\text{CF} \times \Delta T_2}{2 \times n}$
- D. $\frac{\text{CF} \times \Delta T_2}{n}$

Question 20

During the production of electricity in a coal-fired power station, energy is present in the following forms.

- I mechanical energy of turbine
 II chemical energy of coal and oxygen
 III thermal energy of steam

The amount of energy in each of these forms that take part in the generation of a fixed quantity of electricity is, **from lowest to highest**

- A. III, I, II
 B. I, II, III
 C. I, III, II
 D. II, III, I

SECTION B – Short answer questions**Instructions for Section B**

Answer **all** questions in the spaces provided.

To obtain full marks for your responses you should

- give simplified answers with an appropriate number of significant figures to all numerical questions; unsimplified answers will not be given full marks.
- show all working in your answers to numerical questions. No credit will be given for an incorrect answer if it is not accompanied by details of the working.
- make sure chemical equations are balanced and that the formulas for individual substances include an indication of state; for example, $\text{H}_2(\text{g})$; $\text{NaCl}(\text{s})$

Question 1

Refer to the **periodic table** in the data sheet when answering this question.

Identify each of the following elements on the basis of the properties listed in the table below. Write its chemical symbol in the appropriate box in the third column.

	Property	Chemical symbol of the element
i.	The element which forms an ion with electron configuration of $1s^22s^22p^6$ and a charge of $2+$	
ii.	The third member of the actinides	
iii.	A period 3 element which forms an ionic oxide that reacts with both acids and bases	
iv.	In the ground state, atoms of this element have electrons in 2 shells and the first four ionisation energies are 0.80, 2.43, 3.66 and $25.02 \text{ MJ mol}^{-1}$	
v.	An element that is more electronegative than chlorine and its atoms have an outer-shell configuration of s^2p^4	
vi.	An element which is more metallic than germanium ($Z = 32$), has a higher first ionisation energy than bismuth ($Z = 83$) and atoms with an outer-shell configuration of s^2p^2	

Total 6 marks

Question 2

The work of many scientists has contributed to an understanding of atomic structure. As a result of their work, previously unknown elements have been discovered and the search for new elements continues today.

- a. Dimitri Mendeleev (1834–1907) is usually given much of the credit for systematically arranging the elements into a periodic table. Briefly describe two important features of the table he created.

2 marks

- b. The discovery of element 113 was claimed by teams of Russian and American scientists in February 2004. Following international conventions, it has initially been given the name ununtrium and the symbol Uut, before a permanent name and symbol are given to it.

Uut undergoes rapid radioactive decay but atoms of Uut have been identified with a mass number of 283 and also with a mass number of 284.

- i. Name an instrument that could be used to determine the mass numbers of different isotopes of an element.

- ii. State the number of subatomic particles in an uncharged Uut atom of mass number 284.

protons _____ electrons _____ neutrons _____

- iii. In what group and period is Uut located in the periodic table?

group _____ period _____

- iv. Give the symbol of the element that is expected to be **most** similar to Uut in chemical properties.

- v. In terms of atomic structure, explain why the atomic radius of Uut is predicted to be smaller than that of Fr ($Z = 87$).

- vi. In terms of atomic structure, explain why the first ionisation energy of Uut is predicted to be smaller than that of Al ($Z = 13$).

- vii. Atoms of Uut with a mass number of 283 undergo radioactive decay into two particles, one of which is an α -particle (a helium nucleus). Write a balanced equation for this nuclear reaction.

1 + 1 + 2 + 1 + 1 + 1 + 1 + 1 = 8 marks

Total 10 marks

Question 3

The arrangements of electrons in atoms and ions are often written in simplified form, known as ‘condensed electron configurations’. For example, the condensed electron configuration of beryllium is written as

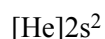

where [He] stands for the electron configuration of helium ($1s^2$), which is the noble gas element previous to beryllium in the periodic table.

- a. Write condensed electron configurations for the following atoms and ions.

i. C _____

ii. Fe _____

iii. Fe^{3+} _____

1 + 1 + 1 = 3 marks

- b. State the group and period of the periodic table where an element with the electron configuration $[\text{Kr}]4d^{10}5s^25p^4$ is found.

group _____ period _____

1 mark

Total 4 marks

Question 4

- a. A structure for the disaccharide maltose ($C_{12}H_{22}O_{11}$) is given below.

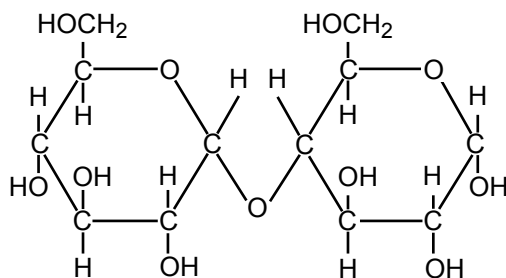

- i. Maltose undergoes enzyme-catalysed hydrolysis during digestion. Give the molecular formula of the product of this hydrolysis.

- ii. Write a balanced equation for the combustion of one mole of maltose ($C_{12}H_{22}O_{11}$) in the presence of excess oxygen.

- iii. The monosaccharide from the hydrolysis of maltose also undergoes combustion in excess oxygen. Combustion of one mole of this monosaccharide releases 2816 kJ. Give a numerical estimate for the value of ΔH for the combustion of one mole of maltose and explain the reasoning behind your estimate.

1 + 2 + 1 = 4 marks

- b. Most fats and oils contain the ester functional group formed by a condensation reaction between 1 molecule of glycerol and 3 molecules of fatty acids.

- i. How many hydrogen atoms are there in a molecule of a **monounsaturated** fatty acid with 16 carbon atoms?

ii. In the space below, clearly draw a structural formula for glycerol. Show **all** bonds.

1 + 1 = 2 marks

c. A potentially useful vehicle fuel is manufactured by a condensation reaction between one molecule of methanol (CH_3OH) and one molecule of a fatty acid. A particular fuel, methyl stearate, is produced when the fatty acid stearic acid ($\text{C}_{17}\text{H}_{35}\text{COOH}$) reacts with methanol.

i. Write a balanced equation for the formation of methyl stearate from methanol and stearic acid.

ii. On the product formed in **part i.**, clearly circle a complete ester group.

2 + 1 = 3 marks

d. Mayonnaise is an example of an oil-in-water emulsion. It is stabilised by the addition of egg yolk, which contains the emulsifier lecithin (structure below).

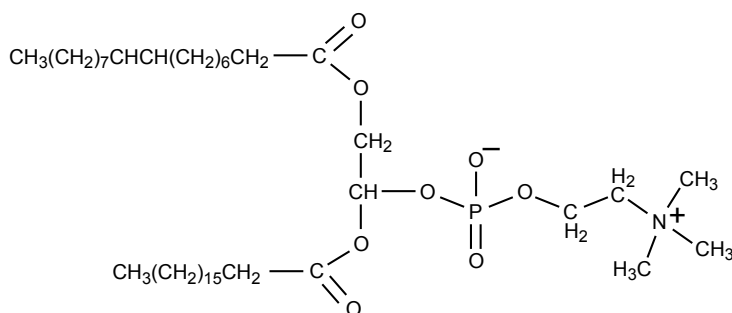

In terms of its structure, explain why the lecithin molecule is able to act as an emulsifier.

2 marks

Total 11 marks

SECTION B – continued

www.theallpapers.com **TURN OVER**

Question 5

- a. i. Draw the full structural formula of the 2-amino acid (α -amino acid) which has the molecular formula $C_3H_7NO_2$. Clearly show **all** bonds.
- ii. The amino acid drawn in **part i.** can form two different dipeptides as a result of condensation reactions with the 2-amino acid $C_2H_5NO_2$. Draw a structural formula of one of the dipeptides formed in the reaction between one molecule of each of these two amino acids.

1 + 2 = 3 marks

- b. The primary structure of a section of a food protein chain is shown below. The formulas of the side chain groups Z_1 , Z_2 , Z_3 and Z_4 are also given.

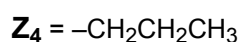
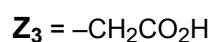
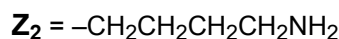
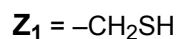
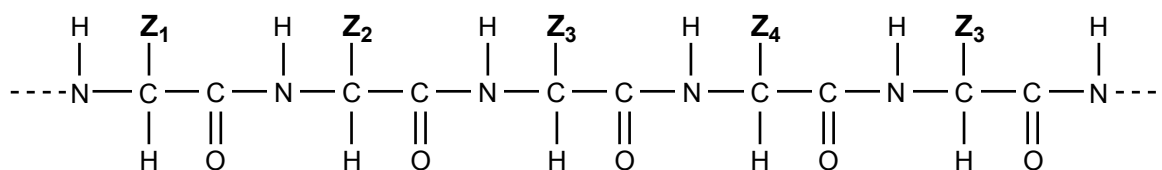

- i. On the above section of the protein chain, circle one complete peptide link.
- ii. Which one of the side chain groups, Z_1 to Z_4 , would be positively charged at pH 2?

- iii. Which one of the side chain groups, Z_1 to Z_4 , is often involved in the formation of covalent cross links which stabilise the tertiary structure of a protein?

- iv. Carboxypeptidase is an enzyme that catalyses the digestion of food protein in the small intestine where the pH is approximately 8. However, it does not catalyse the digestion of food protein in the stomach where the pH is very low. Suggest a reason for this difference.

- v. Following digestion of this protein, nitrogen containing wastes will be produced. This waste nitrogen is excreted largely as urea. In the space below draw the full structural formula of the urea molecule. Clearly show **all** bonds.

1 + 1 + 1 + 1 + 1 = 5 marks

Total 8 marks

Question 6

Ethanol (C_2H_5OH) is a common fuel burnt in some lightweight, compact stoves suitable for use when hiking and camping. A diagram of such a stove is given below.

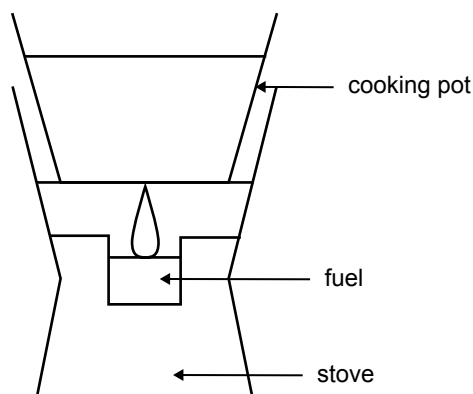

a. Consider the following information.

- Ethanol burns in excess air according to the following equation.

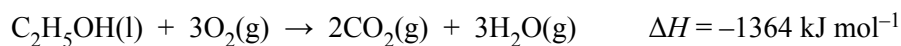

- The cooking pot is made from aluminium and has a mass of 150 g.
 - The specific heat capacity of aluminium is $0.900 \text{ J g}^{-1}\text{C}^{-1}$.
 - The specific heat capacity of water is $4.18 \text{ J g}^{-1}\text{C}^{-1}$.
- i. Calculate the minimum amount of energy, in kJ, required to heat 550 g of water and the pot from 18.5°C to 100.0°C .

- ii. Calculate the mass, in g, of ethanol that needs to be completely burnt to provide this energy.

- iii. Only 35% of the energy released by the combustion of ethanol is transferred to the cooking pot and contents. Calculate the mass, in g, of ethanol that needs to be burnt in practice to heat the water and the pot from 18.5°C to 100.0°C .

2 + 2 + 1 = 5 marks

- b. Other camping stoves use butane (C_4H_{10}) as fuel. Given that, on complete combustion, 6.00 g of butane releases the same amount of energy as 10.0 g of ethanol, calculate the magnitude of ΔH , in kJ mol^{-1} , for the reaction

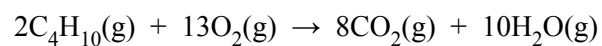

2 marks

Total 7 marks

Question 7

The following diagram represents a $\text{H}^+(\text{aq})/\text{H}_2(\text{g})$ half cell for the reaction

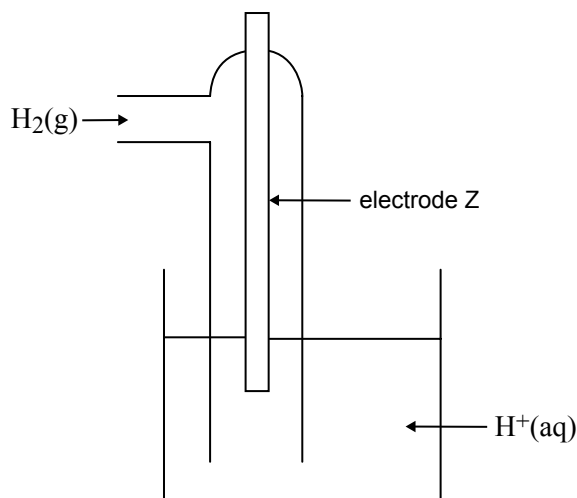
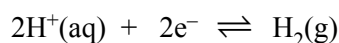

- a. i. For this half cell, identify an appropriate material for electrode Z.

- ii. For this half cell to be a **standard** half cell, state

- the temperature at which it must operate _____
- the required **pH** of the solution of $\text{H}^+(\text{aq})$ ions _____

1 + 2 = 3 marks

- b. A galvanic cell consists of the following half cells which have been set up under standard conditions.

- Half cell 1: the $\text{H}^+(\text{aq})/\text{H}_2(\text{g})$ half cell described in **part a**.
- Half cell 2: a cadmium (Cd) electrode in a solution containing $\text{Cd}^{2+}(\text{aq})$

After some time, the pH in half cell 1 has increased. Use this information to identify the species in this galvanic cell which is the stronger reductant and explain how you reached this conclusion.

The stronger reductant is _____

Explanation _____

2 marks

c. A second galvanic cell consists of the following half cells.

- Half cell 1: an inert electrode in 100.0 mL solution of 1.00 M $X^{2+}(aq)$
- Half cell 2: an electrode of $Cu(s)$ in 100.0 mL solution of 1.00 M $Cu^{2+}(aq)$

This galvanic cell is shown in the diagram below.

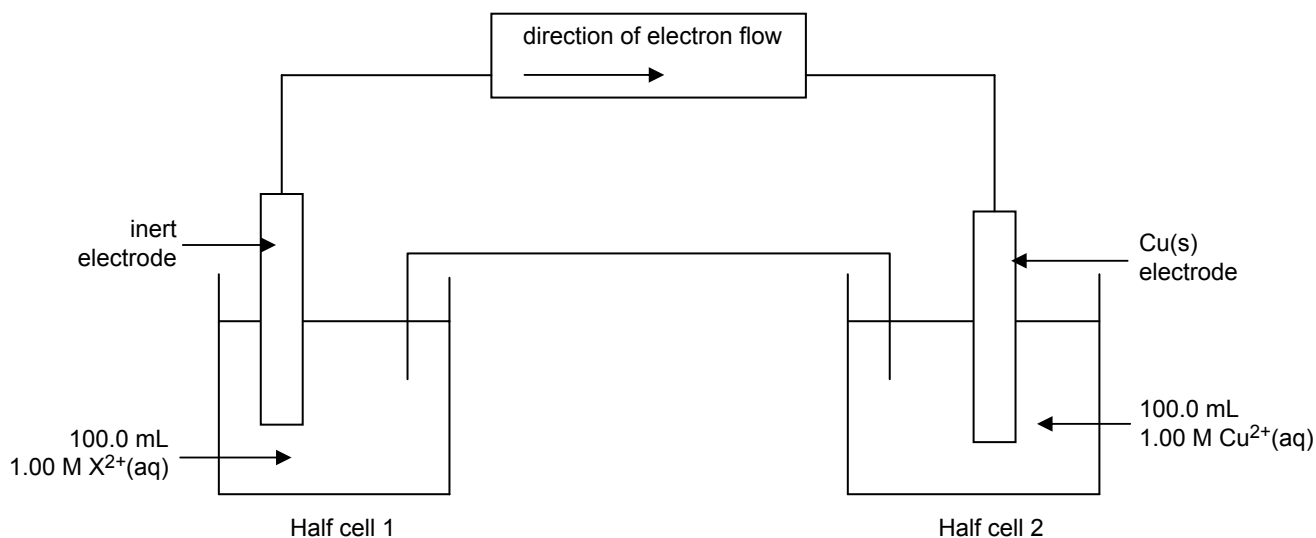

After discharging 2654 C of electricity, the concentration of the $X^{2+}(aq)$ in solution in half cell 1 was found to be 0.725 M. The volume of the solutions in the two half cells had not changed.

- i. Calculate the amount, in mol, of $X^{2+}(aq)$ that reacted in half cell 1.

- ii. Calculate the ratio of $n(X^{2+})$ reacted to $n(e^-)$ that passed through the cell.

That is, calculate: $n(X^{2+})_{\text{reacted}} : n(e^-)$

- iii. State the oxidation state of the product of the half reaction in half cell 1.

- iv. Write an equation for the half reaction that occurred at the electrode of half cell 1.

2 + 2 + 1 + 1 = 6 marks

Total 11 marks

Question 8

Faraday's constant is defined as the charge on one mole of electrons. The value of Faraday's constant can be determined experimentally by electrolysis using inert electrodes.

A current of 1.62 A is passed through a solution of copper (II) nitrate for 581 s. At the end of that time, the copper deposited at the negative electrode was collected. Its mass was found to be 0.306 g.

- a. Write an equation for the half reaction occurring at the negative electrode of this electrolytic cell.

1 mark

- b. Use the experimental data given above to calculate, to an appropriate number of significant figures, the

- charge, in coulombs, that was passed through the electrolytic cell

- amount, in mol, of copper deposited at the negative electrode.

3 marks

- c. Use the values obtained in **part b.** to calculate the experimentally determined value of Faraday's constant.

2 marks

- d. The value of Faraday's constant given in your data sheet is $96\,500\text{ C mol}^{-1}$. The experiment above was repeated and a value for Faraday's constant was found to be $98\,400\text{ C mol}^{-1}$. The amount of charge passed is accurately known. Describe **one** possible source of experimental error which would result in obtaining an experimental value that was higher than the one given in the data sheet.

1 mark

Total 7 marks

CHEMISTRY

Written examination 2

DATA SHEET

Directions to students

Detach this data sheet during reading time.

This data sheet is provided for your reference.

Physical constants

$$F = 96\,500 \text{ C mol}^{-1}$$

$$R = 8.31 \text{ J K}^{-1} \text{ mol}^{-1}$$

$$1 \text{ atm} = 101\,325 \text{ Pa} = 760 \text{ mmHg}$$

$$0^\circ\text{C} = 273 \text{ K}$$

$$\text{Molar volume at STP} = 22.4 \text{ L mol}^{-1}$$

$$\text{Avogadro constant} = 6.02 \times 10^{23} \text{ mol}^{-1}$$

Ideal gas equation

$$pV = nRT$$

The electrochemical series

	E° in volt
$\text{F}_2(\text{g}) + 2\text{e}^- \rightarrow 2\text{F}^-(\text{aq})$	+2.87
$\text{H}_2\text{O}_2(\text{aq}) + 2\text{H}^+(\text{aq}) + 2\text{e}^- \rightarrow 2\text{H}_2\text{O}(\text{l})$	+1.77
$\text{Au}^+(\text{aq}) + \text{e}^- \rightarrow \text{Au}(\text{s})$	+1.68
$\text{Cl}_2(\text{g}) + 2\text{e}^- \rightarrow 2\text{Cl}^-(\text{aq})$	+1.36
$\text{O}_2(\text{g}) + 4\text{H}^+(\text{aq}) + 4\text{e}^- \rightarrow 2\text{H}_2\text{O}(\text{l})$	+1.23
$\text{Br}_2(\text{l}) + 2\text{e}^- \rightarrow 2\text{Br}^-(\text{aq})$	+1.09
$\text{Ag}^+(\text{aq}) + \text{e}^- \rightarrow \text{Ag}(\text{s})$	+0.80
$\text{Fe}^{3+}(\text{aq}) + \text{e}^- \rightarrow \text{Fe}^{2+}(\text{aq})$	+0.77
$\text{I}_2(\text{s}) + 2\text{e}^- \rightarrow 2\text{I}^-(\text{aq})$	+0.54
$\text{O}_2(\text{g}) + 2\text{H}_2\text{O}(\text{l}) + 4\text{e}^- \rightarrow 4\text{OH}^-(\text{aq})$	+0.40
$\text{Cu}^{2+}(\text{aq}) + 2\text{e}^- \rightarrow \text{Cu}(\text{s})$	+0.34
$\text{S}(\text{s}) + 2\text{H}^+(\text{aq}) + 2\text{e}^- \rightarrow \text{H}_2\text{S}(\text{g})$	+0.14
$2\text{H}^+(\text{aq}) + 2\text{e}^- \rightarrow \text{H}_2(\text{g})$	0.00
$\text{Pb}^{2+}(\text{aq}) + 2\text{e}^- \rightarrow \text{Pb}(\text{s})$	-0.13
$\text{Sn}^{2+}(\text{aq}) + 2\text{e}^- \rightarrow \text{Sn}(\text{s})$	-0.14
$\text{Ni}^{2+}(\text{aq}) + 2\text{e}^- \rightarrow \text{Ni}(\text{s})$	-0.23
$\text{Co}^{2+}(\text{aq}) + 2\text{e}^- \rightarrow \text{Co}(\text{s})$	-0.28
$\text{Fe}^{2+}(\text{aq}) + 2\text{e}^- \rightarrow \text{Fe}(\text{s})$	-0.44
$\text{Zn}^{2+}(\text{aq}) + 2\text{e}^- \rightarrow \text{Zn}(\text{s})$	-0.76
$2\text{H}_2\text{O}(\text{l}) + 2\text{e}^- \rightarrow \text{H}_2(\text{g}) + 2\text{OH}^-(\text{aq})$	-0.83
$\text{Mn}^{2+}(\text{aq}) + 2\text{e}^- \rightarrow \text{Mn}(\text{s})$	-1.03
$\text{Al}^{3+}(\text{aq}) + 3\text{e}^- \rightarrow \text{Al}(\text{s})$	-1.67
$\text{Mg}^{2+}(\text{aq}) + 2\text{e}^- \rightarrow \text{Mg}(\text{s})$	-2.34
$\text{Na}^+(\text{aq}) + \text{e}^- \rightarrow \text{Na}(\text{s})$	-2.71
$\text{Ca}^{2+}(\text{aq}) + 2\text{e}^- \rightarrow \text{Ca}(\text{s})$	-2.87
$\text{K}^+(\text{aq}) + \text{e}^- \rightarrow \text{K}(\text{s})$	-2.93
$\text{Li}^+(\text{aq}) + \text{e}^- \rightarrow \text{Li}(\text{s})$	-3.02

Periodic table of the elements

1 H 1.0																	2 He 4.0
3 Li 6.9	4 Be 9.0															9 F 19.0	10 Ne 20.1
11 Na 23.0	12 Mg 24.3															17 Cl 35.5	18 Ar 39.9
19 K 39.1	20 Ca 40.1	21 Sc 44.9	22 Ti 47.9	23 V 50.9	24 Cr 52.0	25 Mn 54.9	26 Fe 55.9	27 Co 58.9	28 Ni 58.7	29 Cu 63.6	30 Zn 65.4	31 Ga 69.7	32 Ge 72.6	33 As 74.9	34 Se 79.0	35 Br 79.9	36 Kr 83.8
37 Rb 85.5	38 Sr 87.6	39 Y 88.9	40 Zr 91.2	41 Nb 92.9	42 Mo 95.9	43 Tc 98.1	44 Ru 101.1	45 Rh 102.9	46 Pd 106.4	47 Ag 107.9	48 Cd 112.4	49 In 114.8	50 Sn 118.7	51 Sb 121.8	52 Te 127.6	53 I 126.9	54 Xe 131.3
55 Cs 132.9	56 Ba 137.3	57 La 138.9	72 Hf 178.5	73 Ta 180.9	74 W 183.8	75 Re 186.2	76 Os 190.2	77 Ir 192.2	78 Pt 195.1	79 Au 197.0	80 Hg 200.6	81 Tl 204.4	82 Pb 207.2	83 Bi 209.0	84 Po (209)	85 At (210)	86 Rn (222)
87 Fr (223)	88 Ra (226)	89 Ac (227)	104 Rf (261)	105 Db (262)	106 Sg (266)	107 Bh (264)	108 Hs (277)	109 Mt (268)	110 Ds (271)	111 Rg (272)	112 Uub	114 Uuq	116 Uuh	118 Uuo			

58 Ce 140.1	59 Pr 140.9	60 Nd 144.2	61 Pm (145)	62 Sm 150.3	63 Eu 152.0	64 Gd 157.2	65 Tb 158.9	66 Dy 162.5	67 Ho 164.9	68 Er 167.3	69 Tm 168.9	70 Yb 173.0	71 Lu 175.0
---------------------------------	---------------------------------	---------------------------------	---------------------------------	---------------------------------	---------------------------------	---------------------------------	---------------------------------	---------------------------------	---------------------------------	---------------------------------	---------------------------------	---------------------------------	---------------------------------

90 Th 232.0	91 Pa 231.0	92 U 238.0	93 Np 237.1	94 Pu (244)	95 Am (243)	96 Cm (247)	97 Bk (247)	98 Cf (251)	99 Es (252)	100 Fm (257)	101 Md (258)	102 No (259)	103 Lr (262)
---------------------------------	---------------------------------	--------------------------------	---------------------------------	---------------------------------	---------------------------------	---------------------------------	---------------------------------	---------------------------------	---------------------------------	----------------------------------	----------------------------------	----------------------------------	----------------------------------