



# Victorian Certificate of Education 2002

SUPERVISOR TO ATTACH PROCESSING LABEL HERE

## STUDENT NUMBER

Figures

Words

									Letter

# BIOLOGY

## Written examination 2

Monday 4 November 2002

Reading time: 3.00 pm to 3.15 pm (15 minutes)

Writing time: 3.15 pm to 4.45 pm (1 hour 30 minutes)

## QUESTION AND ANSWER BOOK

### Structure of book

Section	Number of questions	Number of questions to be answered	Number of marks	Suggested times (minutes)
A	25	25	25	30
B	8	8	50	60
			Total 75	90

- Students are permitted to bring into the examination room: pens, pencils, highlighters, erasers, sharpeners and rulers.
- Students are NOT permitted to bring into the examination room: blank sheets of paper and/or white out liquid/tape.
- No calculator is allowed in this examination.

### Materials supplied

- Question and answer book of 22 pages.
- Answer sheet for multiple-choice questions.

### Instructions

- Write your **student number** in the space provided above on this page.
- Check that your **name** and **student number** as printed on your answer sheet for multiple-choice questions are correct, **and** sign your name in the space provided to verify this.
- All written responses must be in English.

### At the end of the examination

- Place the answer sheet for multiple-choice questions inside the front cover of this book.

**Students are NOT permitted to bring mobile phones and/or any other electronic communication devices into the examination room.**

**SECTION A – Multiple-choice questions****Instructions for Section A**

Answer all questions in pencil on the answer sheet for multiple-choice questions. A correct answer scores 1, an incorrect answer scores 0. Marks will **not** be deducted for incorrect answers. No mark will be given if more than one answer is completed for any question.

Use the following information to answer Questions 1 and 2.

Phenylketonuria (PKU) is inherited as an autosomal recessive condition. In the following pedigree (Figure 1) shaded individuals have this trait.

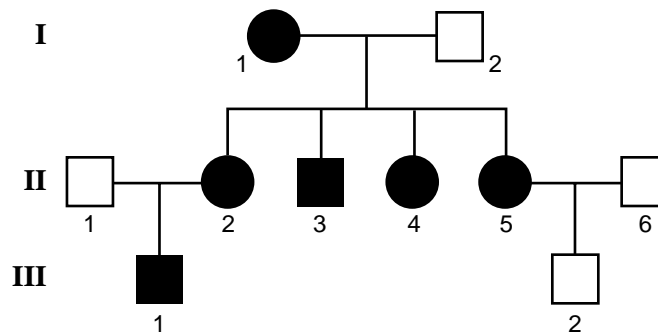

Figure 1

**Question 1**

With respect to the PKU gene locus, you could reasonably conclude that individual

- A. I – 1 is homozygous.
- B. I – 2 is homozygous.
- C. II – 5 is heterozygous.
- D. III – 1 is heterozygous.

**Question 2**

If II – 1 and II – 2 have another child, the chance that they will have a child affected by PKU is

- A.  $\frac{1}{4}$
- B.  $\frac{1}{3}$
- C.  $\frac{1}{2}$
- D. 1

*Use the following information to answer Question 3.*

The gene responsible for the autosomal recessive condition PKU controls the production of an enzyme that converts the amino acid phenylalanine to tyrosine. The gene has the alleles

- P** : produced enzyme  
**p** : no enzyme produced

In a person lacking the enzyme, phenylalanine accumulates in toxic levels throughout the body and the disease develops.

Development of the disease is prevented by placing a baby, who lacks the enzyme, on a special diet a few days after birth. This diet is low in phenylalanine and is maintained for as long as possible, preferably for life.

### Question 3

With respect to PKU,

- A. the special diet for babies with the disease would also contain reduced levels of tyrosine.
- B. each person in a population would have one of three possible genotypes at the PKU gene locus.
- C. a PKU individual treated from soon after birth would not be able to pass allele **p** onto their offspring.
- D. because the disease can be treated, one would expect the number of babies born with PKU to decline over time.

*Use the following information to answer Question 4.*

A scientist used a light microscope to examine a range of human cells and the structures they contained. Figure 2 represents a structure seen in one of the cells.

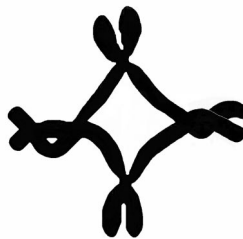

**Figure 2**

### Question 4

The cell could come from

- A. skin.
- B. liver.
- C. testes.
- D. bone marrow.

### Question 5

Colour blindness is inherited as an X-linked recessive condition.

It is reasonable to claim that a

- A. colour-blind female must have a colour-blind father.
- B. colour-blind male must have a colour-blind mother.
- C. colour-blind male must have a colour-blind grandfather.
- D. colour-blind female must have a colour-blind grandmother.

*Use the following information to answer Question 6.*

In cattle, the presence or absence of a white saddle-shaped marking across the back of an otherwise coloured coat is under the control of a single autosomal gene.

The gene has the alleles

- S** : white saddle present
- s** : solid-colour coat (for example black)

### Question 6

With respect to this gene, it is reasonable to predict that the cross

- A.** SS x Ss results in both solid-coloured and white-saddle cattle.
- B.** Ss x Ss results in both solid-coloured and white-saddle cattle.
- C.** SS x SS results in only solid-coloured cattle.
- D.** ss x ss results in only white-saddle cattle.

### Question 7

Variation in some traits is due to the action of many genes.

These traits are said to be

- A.** polymorphic.
- B.** polypeptic.
- C.** polygenic.
- D.** polyploid.

### Question 8

The origin of new alleles at a gene locus is the result of

- A.** migration.
- B.** mutation.
- C.** recombination.
- D.** independent assortment.

*Use the following information to answer Question 9.*

The ABO blood group system is under the control of a single gene with the alleles

- I<sup>A</sup>** : presence of protein A on red blood cells
- I<sup>B</sup>** : presence of protein B on red blood cells
- i** : neither protein A or B on red blood cells

### Question 9

With respect to this gene

- A.** an individual could have one of eight different genotypes.
- B.** an individual could have one of six different phenotypes.
- C.** a child could have protein A even if both parents lacked protein A on their red blood cells.
- D.** a child with neither protein A nor B could have a mother with protein A and a father with protein B.

SECTION A – continued

Use the following information to answer Question 10.

A particular species of plant has the following genes and alleles.

Leaf shape	<b>L</b>	:	normal shape
	<b>l</b>	:	wrinkled shape
Number of seed cases	<b>P</b>	:	one seed case
	<b>p</b>	:	three seed cases

A cross between two parents produced the following offspring.

Phenotype	Number of offspring
three seed cases and wrinkled leaves	32
one seed case and wrinkled leaves	100
three seed cases and normal leaves	96
one seed case and normal leaves	290

### Question 10

The genotypes of the two parents would be

- A.  $ppll \times PPLL$
- B.  $Ppll \times PPLL$
- C.  $PpLl \times PpLl$
- D.  $PPLl \times PpLl$

Use the following information to answer Question 11.

Figure 3 represents a length of DNA and its cutting sites for the restriction enzymes *Spe* I, *Eco* RI, *Bgl* II and *Hin* dIII.



Figure 3

### Question 11

Incubation of this length of DNA in a tube containing

- A. *Spe* I would result in three pieces of DNA.
- B. *Hin* dIII would result in two pieces of DNA.
- C. *Spe* I and *Eco* RI would result in five pieces of DNA.
- D. *Bgl* II and *Hin* dIII would result in four pieces of DNA.

Use the following information to answer Question 12.

Radioisotopes may be used to establish the age of rocks and fossils. Potassium-40 is an isotope which decays to argon-40. The half-life of potassium-40 is 1.3 million years.

Figure 4 shows the proportion of potassium-40 (%) remaining in rock over a period of millions of years.

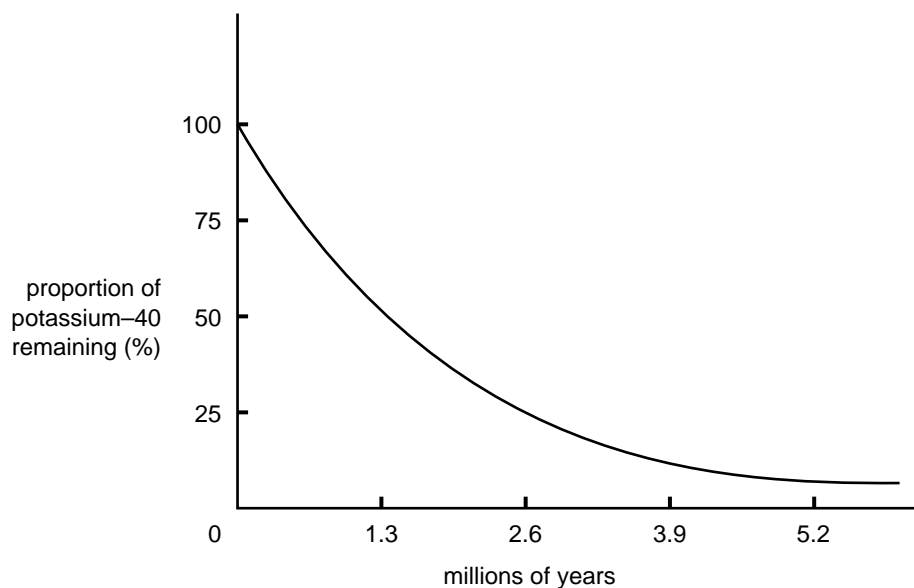

**Figure 4**

**Question 12**

A rock was found to have 25 per cent potassium-40 remaining.

The approximate age of the rock is

- A. 0.65 million years.
- B. 1.3 million years.
- C. 2.6 million years.
- D. 3.9 million years.

**Question 13**

Populations of bacteria can evolve rapidly in response to changes in the environment.

One factor which contributes to this is that bacteria

- A. have a single chromosome.
- B. have a short generation time.
- C. are single-celled organisms.
- D. have a low rate of mutation.

**Question 14**

Many frog species inhabiting tropical rainforests have evolved green skin colour.

It would be reasonable to conclude that the main selection pressure responsible for the evolution of green skin colour is

- A. predation.
- B. climate.
- C. reproduction.
- D. infection by pathogens.

Use the following information to answer Question 15.

Figure 5 represents one view of the evolutionary relationships between some Australian venomous snakes.

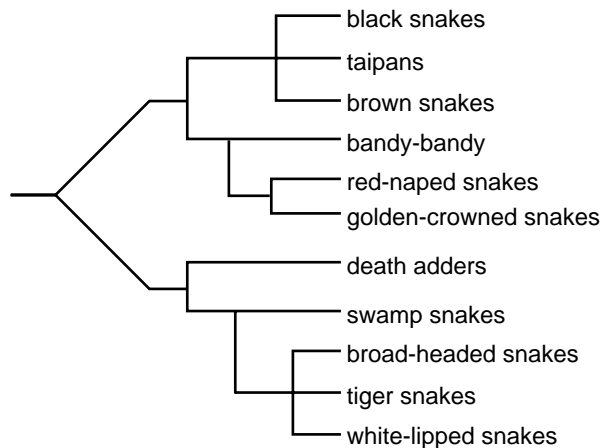

Figure 5

### Question 15

From this diagram it would be reasonable to conclude that

- A. white-lipped snakes and black snakes lack a common ancestor.
- B. tiger snakes share more characteristics with brown snakes than with swamp snakes.
- C. death adders are more closely related to golden-crowned snakes than they are to tiger snakes.
- D. broad-headed snakes share a more recent common ancestor with white-lipped snakes than they do with swamp snakes.

### Question 16

Genetic drift is

- A. most evident in large populations.
- B. the gene flow between populations.
- C. random changes in the gene pool of a population.
- D. the gradual change in phenotypic frequency resulting from natural selection.

### Question 17

The shingleback lizard is closely related to the bluetongue lizard. The bluetongue has a long pointed tail and smooth scales. The shingleback has a short stumpy tail and enlarged rough scales.

The evolution of these characteristics in the shingleback is an example of which type of evolution?

- A. cultural
- B. parallel
- C. divergent
- D. convergent

Use the following information to answer Question 18.

A comparison was made between human, rabbit, mouse and chimpanzee of the

- DNA coding sequence of the  $\beta$  globin gene
- DNA sequence in the introns of the  $\beta$  globin gene
- amino acid sequence of the  $\beta$  globin polypeptide.

The data is shown in Table 1.

**Table 1**

Organisms being compared	sequence similarity (%)		
	coding DNA	intron	amino acid sequence
human $\beta$ globin/chimpanzee $\beta$ globin	100	98.4	100
human $\beta$ globin/rabbit $\beta$ globin	89.3	67	90.4
human $\beta$ globin/mouse $\beta$ globin	82.1	61	80.1

**Question 18**

It is possible to conclude from this data that

- a human is more closely related to a mouse than to a rabbit.
- the variation between chimpanzees and humans occurs in a region of the  $\beta$  globin gene which would code for amino acids.
- the variation in the intron sequence between human and mouse would account for some of the differences in the amino acid sequence.
- the comparison between rabbit and human indicates that the differences in their DNA did not always make a difference to the amino acid produced.

**Question 19**

The common evolutionary ancestry of many organisms is reflected by a geographic distribution consistent with the former supercontinent Gondwanaland.

An example of this is the distribution of

- parastacid crayfish in South America, New Zealand, Australia and New Guinea.
- bears in North and South America, Europe and Asia.
- flying foxes in Australia, Asia, Africa and Europe.
- mockingbirds in South and North America.



Use the following information to answer Question 20.

Figure 6 below shows an aerial view of a region which included a section of copper contaminated soil (shaded grey on the diagram). The black circles represent populations of grass growing in areas A, B and C. The diagram also includes the percentage of copper resistant plants in areas A, B and C. Tolerance to copper in the soil is genetically determined.

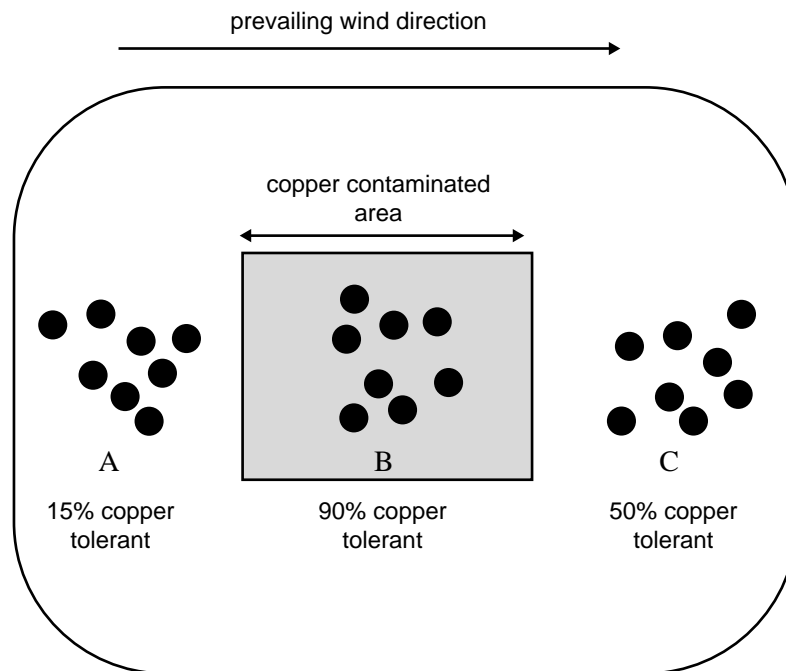

Figure 6

### Question 20

It is reasonable to conclude from the information that

- A. all plants in the copper contaminated area would be homozygous at the gene locus for copper tolerance.
- B. high levels of copper tolerance would be a selective advantage for all plants in areas A, B and C.
- C. the difference in copper tolerance between populations in areas A and C is the result of mutation.
- D. gene flow is occurring between populations in areas B and C.

### Question 21

Fossils of soft-bodied organisms are relatively rare because they

- A. were never common in the environments in which they lived.
- B. lived in environments where sedimentation did not occur.
- C. are generally small in size.
- D. readily decompose.

Use the following information to answer Questions 22 and 23.

Figure 7 shows the possible evolutionary relationships between chimpanzees and the genera of humans.

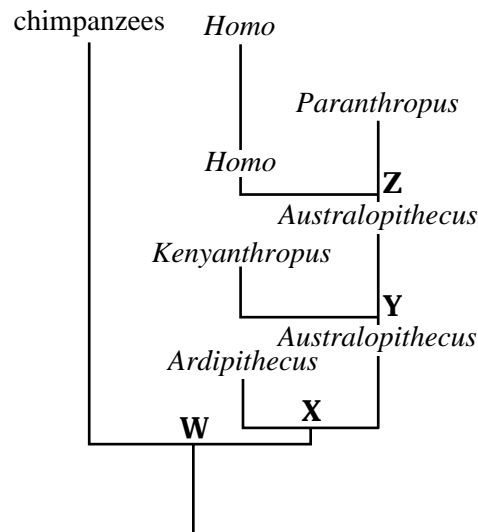

Figure 7

**Question 22**

The most recent common ancestor of *Homo* and *Kenyanthropus* is represented on the diagram at

- A. Z
- B. Y
- C. X
- D. W

**Question 23**

The skull of *Kenyanthropus* was discovered in 1999 in sediments between 3.2 and 3.5 million years old. The skull is unusual in that it shows the combination of a small braincase, flat face and small teeth.

The following characteristics would be seen in the skull of *Homo*.

- A. a small braincase and small teeth
- B. a small braincase and a flat face
- C. a flat face and small teeth
- D. a flat face and large teeth

**Question 24**

The scales of reptiles and the feathers of birds are considered to be homologous structures because they

- A. have arisen as a result of similar selection pressures.
- B. have a common evolutionary origin.
- C. are both forms of skin covering.
- D. serve a similar function.

**Question 25**

A population of birds was described as being in genetic equilibrium (Hardy Weinberg equilibrium) for a gene locus determining beak colour.

It would be reasonable to suggest that

- A. there was gene flow occurring between this population and an adjacent population.
- B. there was selection against one of the beak colours in this population.
- C. the birds in the population were mating at random.
- D. the population was small.

**CONTINUED OVER PAGE**

**SECTION B – Short-answer questions**

**Instructions for Section B**

Answer this section in pen.  
 Answer all questions in the spaces provided.

**Question 1**

The domestic cat, *Felis catus*, has a diploid number of 38.

a. How many chromosomes would a gamete of a cat contain? \_\_\_\_\_

1 mark

Genetic ‘accidents’ can occur to chromosomes. One type of accident is when one chromosome becomes permanently attached to another. This kind of arrangement is called a translocation.

A scientist observed a translocation involving chromosomes 9 and 18 in somatic cells of a male cat. Figure 8 shows chromosomes 9 and 18 in a normal male cat and their arrangement in the cat carrying the translocation. Note that the centromere of the translocated number 18 chromosome has been lost.

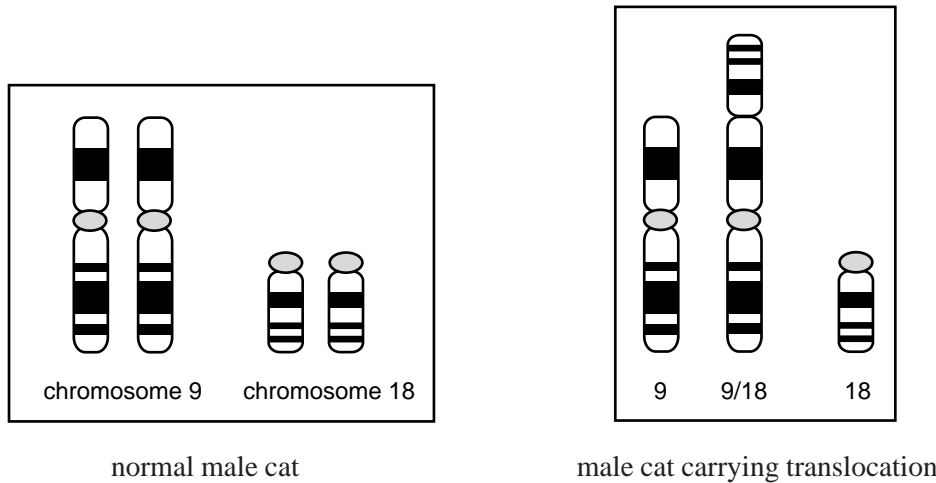

**Figure 8**

In some cases translocations lead to abnormalities, but that was not the case here. The cat had a normal phenotype.

b. i. What is meant by the phenotype of an organism?

---



---

ii. The cat with the translocation had only 37 chromosomes in each somatic cell. Explain why it still had a normal phenotype.

---



---

1 + 1 = 2 marks

The cat's reproductive tissue also contained the translocation, and investigation showed that he produced four different kinds of sperm with respect to chromosomes 9 and 18. Two of these four types are shown in Table 2.

**Table 2**

Chromosome make-up of sperm type 1	Chromosome make-up of sperm type 3
one chromosome 9 <b>and</b> one chromosome 18	
Chromosome make-up of sperm type 2	Chromosome make-up of sperm type 4
one translocation 9/18 chromosome <b>and</b> one chromosome 18	

- c. Complete Table 2 by naming the chromosome make-up of sperm types 3 and 4 respectively.

2 marks

One type of sperm produced by the male carrying the translocation does not survive.

- d. i. Explain which type this is most likely to be.

---



---

- ii. The male cat with the translocation is mated to a normal female. What is the chance that he will father a kitten with the same kind of translocation involving chromosomes 9 and 18, and a normal phenotype?

---

1 + 1 = 2 marks

Total 7 marks

**Question 2**

Coat colour in cocker spaniel dogs varies. Four of these colours are black, liver, red and lemon. These four colours result from the interaction of two particular autosomal genes.

The pedigree below (Figure 9) shows the inheritance of coat colour in a group of cocker spaniels.

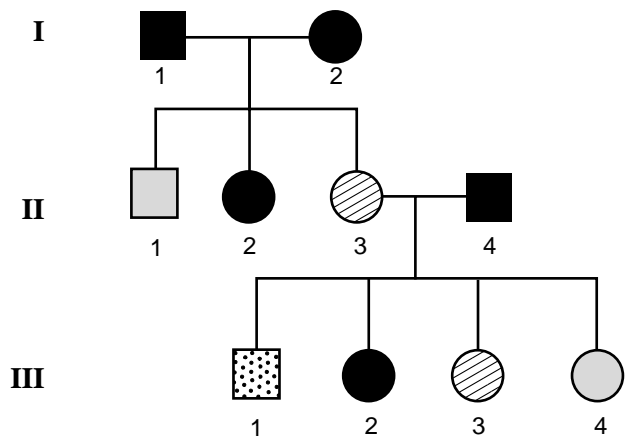

phenotype	generalised genotypes
black	R- B-
liver	rr B-
red	R- bb
lemon	rr bb

Note: R- can be either RR or Rr  
B- can be either BB or Bb

**Figure 9**

- a. I-1 and I-2 are heterozygous at both the R and B locus. What evidence from the pedigree supports this conclusion?

---



---



---



---

2 marks

- b. i. What is the specific genotype of II-4?

---

- ii. What is the specific genotype of III-4?

---

1 + 1 = 2 marks

- c. Explain how many different phenotypes could be expected in the offspring of a mating between individuals II-4 and III-4. Show all working.

---



---



---



---



---



---

2 marks

Total 6 marks

**Question 3**

In a particular insect species, sex is determined by a single gene. The male insect has the genotype **Mm** and the female insect is **mm**. This gene is linked to another gene that determines the body colour of the insect.

a. What is meant by linked genes?

---



---



---

2 marks

The linked gene determining body colour in these insects has two phenotypes, black body colour and bronze body colour. Black body colour is the dominant phenotype.

When a heterozygous black male was crossed with a bronze female the following offspring were produced.

Black male	Black female	Bronze male	Bronze female
47	3	3	47

b. How many map units apart are the genes for body colour and sex determination?

---

1 mark

c. Using the symbol **B** for the allele for black body, and **b** for bronze body colour, write down the genotype for a

i. homozygous black female. \_\_\_\_\_

ii. bronze male. \_\_\_\_\_

1 + 1 = 2 marks

d. Predict the phenotypes of the offspring that would be found in a cross between the two insects described in **c.i.** and **c.ii.**

---



---



---

1 mark

Total 6 marks

**Question 4**

Figure 10 represents a piece of DNA from a gene. The template strand for a section of the gene is shown.

part of the template strand	<b>A A A G T A C T G C G C</b>
complementary strand	

**Figure 10**

- a. In the space provided in Figure 10 write in the complementary bases for the other strand of DNA. 1 mark
- b. What does the A represent in this DNA sequence?  
 \_\_\_\_\_ 1 mark
- c. The first step in the process of gene expression is transcription. What is produced during transcription?  
 \_\_\_\_\_ 1 mark
- d. The compound produced during transcription attaches to an organelle in the cell.
- i. What is the name of this organelle?  
 \_\_\_\_\_
- ii. What is the name of the step in gene expression which follows transcription and occurs at this organelle?  
 \_\_\_\_\_
- iii. What is produced during this process mentioned in part ii.?  
 \_\_\_\_\_

1 + 1 + 1 = 3 marks



In the section of the gene sequence shown in Figure 10 a base substitution mutation occurred. The 9th base from the left, Guanine, was replaced by Thymine (at arrow). The genetic code is provided below (Figure 11).

		Second letter				
		U	C	A	G	
First letter	U	UUU } phe UUC } UUA } leu UUG }	UCU } UCC } ser UCA } UCG }	UAU } tyr UAC } UAA stop UAG stop	UGU } cys UGC } UGA stop UGG trp	U C A G
	C	CUU } leu CUC } CUA } CUG }	CCU } CCC } pro CCA } CCG }	CAU } his CAC } CAA } gln CAG }	CGU } CGC } arg CGA } CGG }	U C A G
	A	AUU } ile AUC } AUA } AUG met	ACU } ACC } thr ACA } ACG }	AAU } asn AAC } AAA } lys AAG }	AGU } ser AGC } AGA } arg AGG }	U C A G
	G	GUU } val GUC } GUA } GUG }	GCU } GCC } ala GCA } GCG }	GAU } asp GAC } GAA } glu GAG }	GGU } GGC } gly GGA } GGG }	U C A G

**Figure 11**

- e. What effect will this mutation have on the sequence of amino acids in the polypeptide?

---

1 mark

Total 7 marks

**Question 5**

There were three suspects in an assault case. A forensic scientist found blood, other than the victim's, at the site. DNA was extracted from five blood samples.

- the victim
- the blood at the assault site (not the victim's)
- the three suspects

Polymerase Chain Reaction (PCR) was used on the extracted DNA.

- a. A DNA polymerase enzyme is involved in the PCR process. Explain the role of the polymerase enzyme in PCR.

---

---

---

---

2 marks

One of the regions used in the forensic analysis was a short tandem repeat (STR) sequence of 4 bases, called HUMTHO1. This sequence, located on chromosome 11, has many alleles which differ from each other by the number of times the sequence AATG is repeated. It was this region of chromosome 11 which was amplified using PCR.

The amplified samples were loaded onto a gel and electrophoresis was performed to separate the fragments of DNA.

- b. Name two properties of the DNA fragments which allow them to be separated from each other during gel electrophoresis.

---

---

---

---

2 marks

A diagram of the gel is shown below (Figure 12).

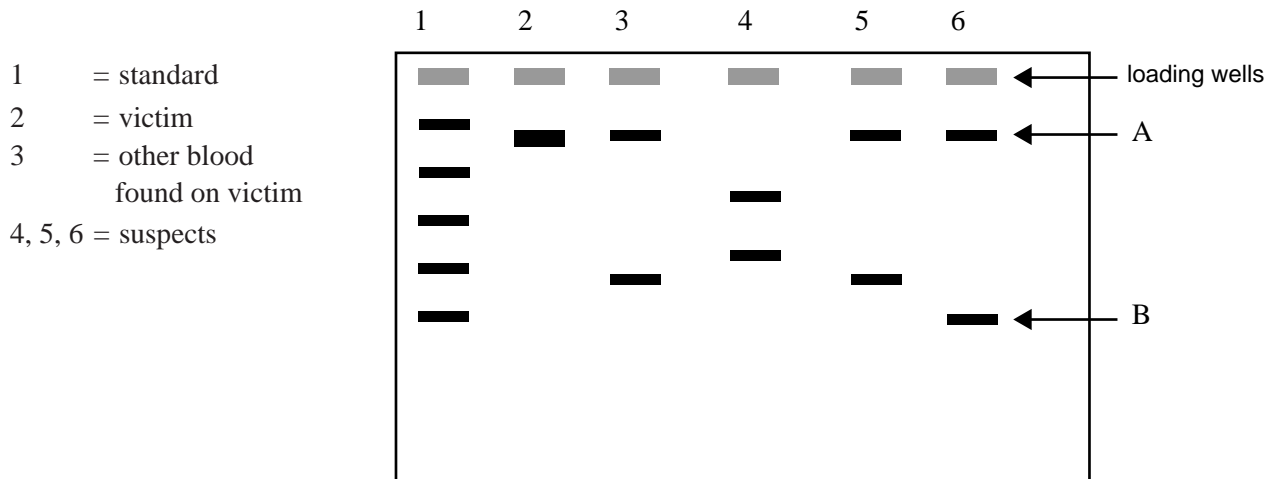

**Figure 12**

- c. Why is there only one band in lane 2 but two bands in lanes 3, 4, 5 and 6?

---



---

1 mark

- d. How many different alleles at the HUMTHO1 locus are represented on the gel in individuals 2, 3, 4, 5, 6?

---

1 mark

- e. Which piece of DNA, A or B, has the greater number of the 4 base repeat sequence?

---

1 mark

- f. Which of the suspects appears to have committed the assault? Explain.

---



---



---

1 mark

Total 8 marks

**Question 6**

To estimate the amount of genetic variation in a species, measures of the average heterozygosity at a number of different gene loci in that species are made.

Results of the average heterozygosity at a number of different gene loci for six different species are shown in Table 3 below.

**Table 3**

	<b>Number of genes examined</b>	<b>Average heterozygosity (%)</b>
human	71	6.7
elephant seal	24	1
horseshoe crab	25	5.7
elephant	32	8.9
<i>Drosophila</i>	24	12
cheetah	27	0

- a. Which organism would you expect to show the most phenotypic variation? Explain.

---



---



---



---

2 marks

- b. Lack of genetic variation is believed to put a species at greater risk of extinction. Explain why low levels of variation put a species at risk of extinction.

---



---



---



---

2 marks

- c. Explain what is meant by the founder effect in the context of population genetics?

---



---



---



---

2 marks

Total 6 marks

**Question 7**

Warfarin is a poison used to control rat populations. Figure 13 shows changes in the proportion of rats resistant to warfarin in a particular population over a period of about 4 years. High levels of warfarin were used on this population during Year 2 but poisoning stopped at the end of this period. Rats are reproductively mature at an age of three months and can breed about every three weeks.

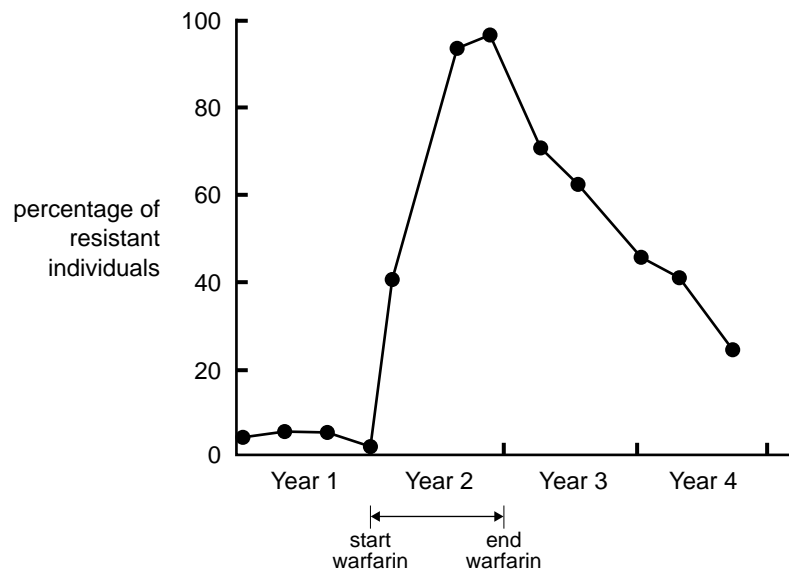
**Figure 13**

- a. Explain the process which led to the increase in the percentage of resistant rats during Year 2.

---

---

---

---

---

---

---

---

---

---

---

---

4 marks

- b. Using the data in Figure 13, explain what can be concluded about the selective advantage to a rat of being warfarin-resistant compared to being nonresistant in an environment without warfarin.

---

---

---

---

---

2 marks

Total 6 marks

**Question 8**

Figure 14 shows the natural distribution of a mammal, the red-necked wallaby, *Macropus rufogriseus*.



**Figure 14**

- a. Give two reasons why populations of this species in Tasmania have not evolved into a separate species despite being geographically isolated by the waters of Bass Strait.

Reason 1 \_\_\_\_\_  
 \_\_\_\_\_

Reason 2 \_\_\_\_\_  
 \_\_\_\_\_

2 marks

- b. Another mammalian species common in Tasmania is the Eastern Quoll, *Dasyurus viverrinus*. This species, which is about the size of a domestic cat, was widely distributed in south-eastern mainland Australia until about 50 years ago. It is now believed to be extinct in Victoria and possibly over the rest of its former range in mainland Australia.

Give two possible reasons for the extinction of this species in mainland Australia.

Reason 1 \_\_\_\_\_  
 \_\_\_\_\_

Reason 2 \_\_\_\_\_  
 \_\_\_\_\_

2 marks

Total 4 marks