



UNIVERSITY OF CAMBRIDGE INTERNATIONAL EXAMINATIONS  
General Certificate of Education Ordinary Level

---

**PHYSICS**

**5054/11**

Paper 1 Multiple Choice

**October/November 2011**

**1 hour**

Additional Materials: Multiple Choice Answer Sheet  
Soft clean eraser  
Soft pencil (type B or HB is recommended)



---

**READ THESE INSTRUCTIONS FIRST**

Write in soft pencil.

Do not use staples, paper clips, highlighters, glue or correction fluid.

Write your name, Centre number and candidate number on the Answer Sheet in the spaces provided unless this has been done for you.

There are **forty** questions on this paper. Answer **all** questions. For each question there are four possible answers **A, B, C** and **D**.

Choose the **one** you consider correct and record your choice in **soft pencil** on the separate Answer Sheet.

**Read the instructions on the Answer Sheet very carefully.**

Each correct answer will score one mark. A mark will not be deducted for a wrong answer.

Any rough working should be done in this booklet.

---

This document consists of **17** printed pages and **3** blank pages.



- 1 The diameter and the length of a thin wire, approximately 1 m in length, are measured as accurately as possible.

What are the best instruments to use?

	diameter	length
<b>A</b>	micrometer	rule
<b>B</b>	micrometer	vernier calipers
<b>C</b>	rule	tape
<b>D</b>	vernier calipers	rule

- 2 A quantity is quoted as having a value of 6.2 ms.

In what units is it measured?

- A** metres  
**B** metres per second  
**C** microseconds  
**D** milliseconds
- 3 The graph shows part of a journey made by a cyclist.

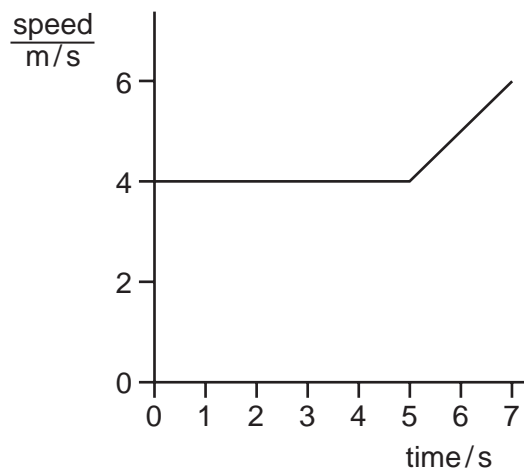

How far did the cyclist travel in 7 s?

- A** 28 m      **B** 30 m      **C** 32 m      **D** 42 m

- 4 The propeller on a boat pushes water backwards with a force of 2000 N. The boat moves through the water against a total resistive force of 1800 N.

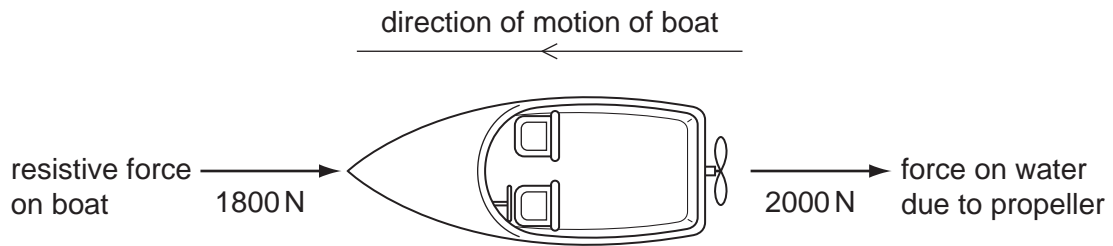

According to Newton's third law, what is the forward force on the propeller due to the water?

- A 200 N      B 1800 N      C 2000 N      D 3800 N
- 5 The diagrams show a parachutist in four positions after she jumps from a high balloon.  
At which position does she have terminal velocity?

- A not yet moving

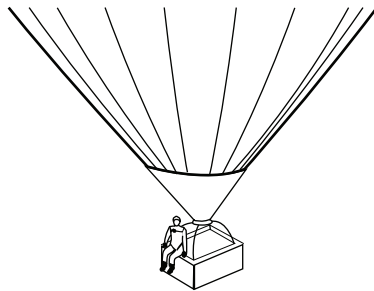

- B accelerating



- C not accelerating

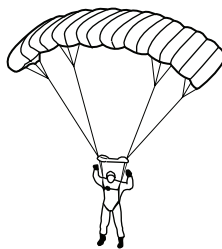

- D not moving



- 6 An engine pulls a truck at constant speed on a level track.

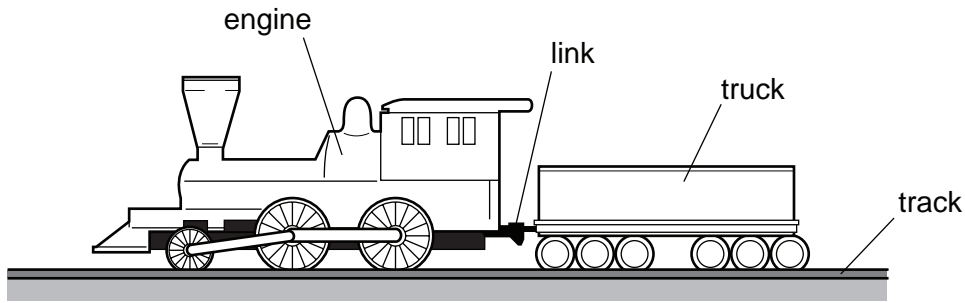

The link between the truck and the engine breaks. The driving force on the engine remains constant.

What effect does this have on the truck and on the engine?

	truck	engine
<b>A</b>	slows down	speed stays constant
<b>B</b>	slows down	speeds up
<b>C</b>	stops immediately	speed stays constant
<b>D</b>	stops immediately	speeds up

- 7 The weight of a stone is found using a newton meter, and its mass is found using a pan balance.

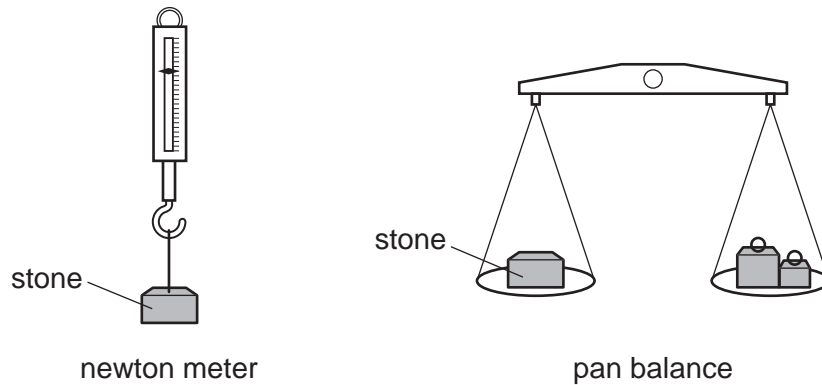

The experiment is carried out on the Earth and on the Moon.

For each meter, is its reading the same or different on the Earth and on the Moon?

	reading on newton meter	reading on pan balance
<b>A</b>	different	different
<b>B</b>	different	same
<b>C</b>	same	different
<b>D</b>	same	same

- 8 The extension of a spring is measured as weights are added. The graph shows the results.  
Which point is the spring's limit of proportionality?

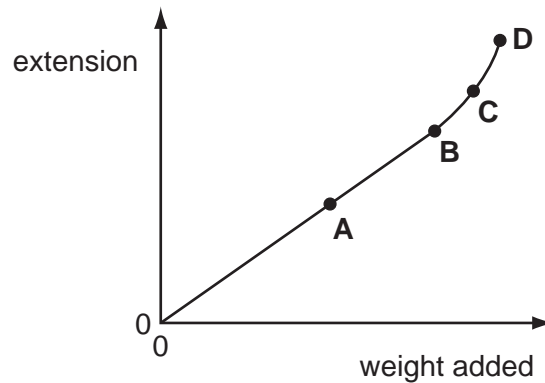

- 9 A metal cone with a circular base is placed on a flat surface.

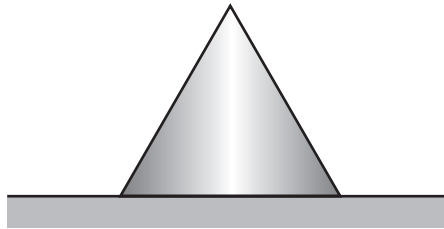

The stability of the cone depends on

- A** its weight only.  
**B** the diameter of its base and the position of its centre of mass.  
**C** the diameter of its base only.  
**D** the position of its centre of mass only.
- 10 The efficiency of an electrical generator is 65%.  
 The energy input to the generator is 12 kJ.  
 What is the useful energy output?
- A** 4.2 kJ      **B** 5.4 kJ      **C** 7.8 kJ      **D** 780 kJ

- 11 Coal is burned as fuel to heat water in a boiler, producing steam. The steam drives a turbine, which is connected to an electric generator.

In which order do the major energy transformations take place?

- A chemical energy  $\rightarrow$  heat energy  $\rightarrow$  electrical energy  $\rightarrow$  kinetic energy  
 B chemical energy  $\rightarrow$  heat energy  $\rightarrow$  kinetic energy  $\rightarrow$  electrical energy  
 C heat energy  $\rightarrow$  chemical energy  $\rightarrow$  electrical energy  $\rightarrow$  kinetic energy  
 D heat energy  $\rightarrow$  chemical energy  $\rightarrow$  kinetic energy  $\rightarrow$  electrical energy
- 12 A crane moves its load diagonally, as shown.

By which distance is the weight of the load multiplied to calculate the change in gravitational potential energy of the load?

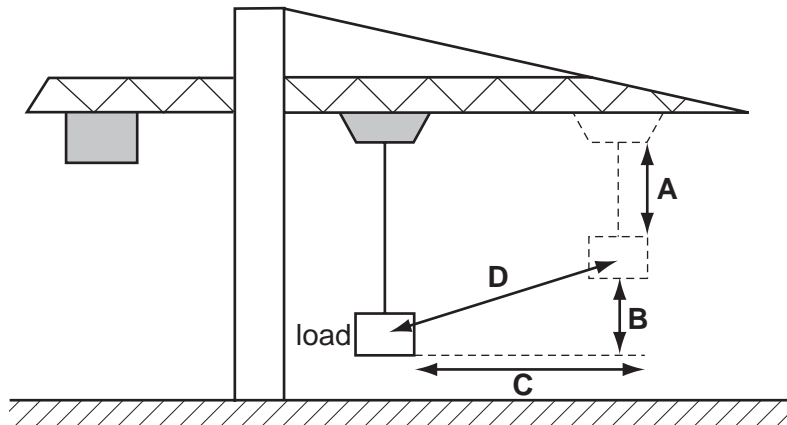

- 13 The diagram shows two identical pieces of apparatus. One is filled with water and the other is filled with mercury. Water is less dense than mercury.

At which point is the liquid pressure greatest?

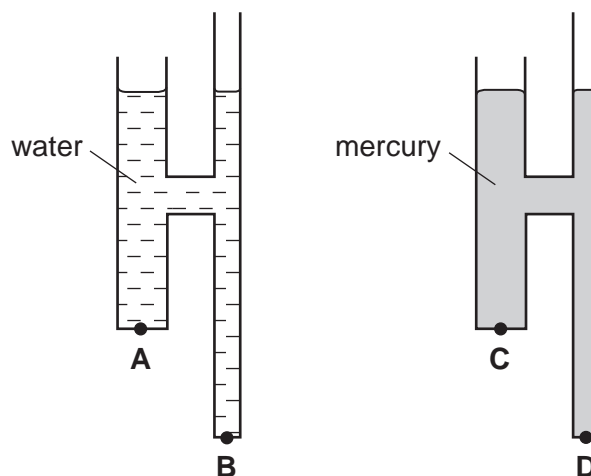

14 Objects with different weights are placed on a rigid, horizontal surface.

Which row shows the correct pressure acting on the surface?

	weight / N	area in contact / m <sup>2</sup>	$\frac{\text{pressure}}{\text{N/m}^2}$
<b>A</b>	10	0.1	1
<b>B</b>	20	0.2	0.01
<b>C</b>	30	0.1	300
<b>D</b>	40	0.2	8

15 How does heat transfer through a vacuum take place?

- A** by conduction, convection and radiation
- B** by conduction only
- C** by convection only
- D** by radiation only

16 Which row explains why a liquid has a fixed volume but does **not** have a fixed shape?

	force between molecules in the liquid	movement of molecules in the liquid
<b>A</b>	large	move throughout the liquid
<b>B</b>	large	vibrate at fixed positions
<b>C</b>	small	move throughout the liquid
<b>D</b>	small	vibrate at fixed positions

17 To raise the temperature of a 2.0 kg block of metal by 20 °C, energy of 5.2 kJ is needed.

What is the value of the specific heat capacity of the metal?

- A** 0.13 J/(kg °C)
- B** 52 J/(kg °C)
- C** 130 J/(kg °C)
- D** 52 000 J/(kg °C)

18 What makes a clinical thermometer suitable for measuring small changes in body temperature?

- A The amount of mercury in the bulb is small.
- B The bore of the capillary tube is narrow.
- C The capillary tube is long.
- D The glass bulb has a thin wall.

19 Substances can change from one state to another as shown.

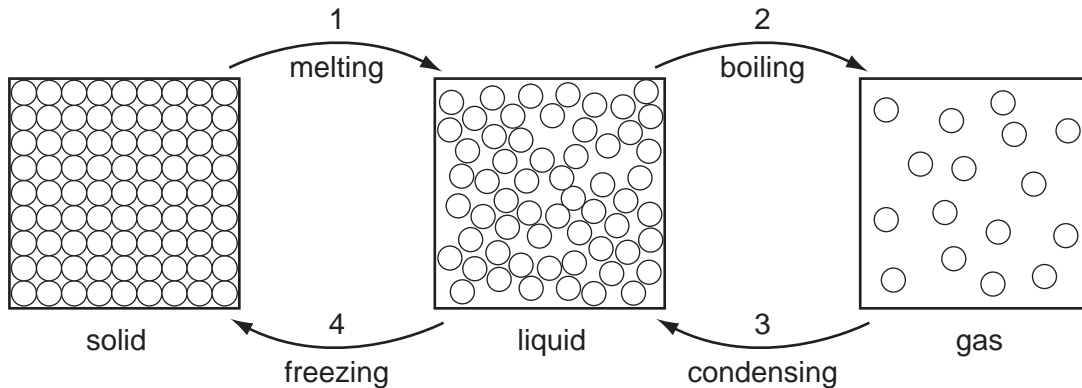

For substances to change from one state to another, there must be some energy transfer.

Which changes involve the substance taking in energy and which changes involve the substance giving out energy?

	energy taken in	energy given out
<b>A</b>	1 and 2	3 and 4
<b>B</b>	1 and 3	2 and 4
<b>C</b>	2 and 4	1 and 3
<b>D</b>	3 and 4	1 and 2

20 How do the speed and the wavelength of red light in air compare with the speed and the wavelength of violet light in air?

	speed of red light	wavelength of red light
<b>A</b>	greater	greater
<b>B</b>	greater	less
<b>C</b>	same	greater
<b>D</b>	same	less



- 21 A ray of light enters a glass block at an angle of incidence  $i$ , producing an angle of refraction  $r$  in the glass.

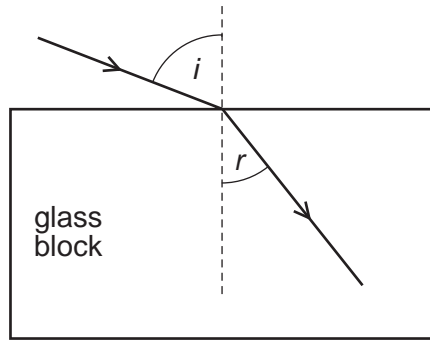

Several different values of  $i$  and  $r$  are measured, and a graph is drawn of  $\sin i$  against  $\sin r$ .

Which graph is correct?

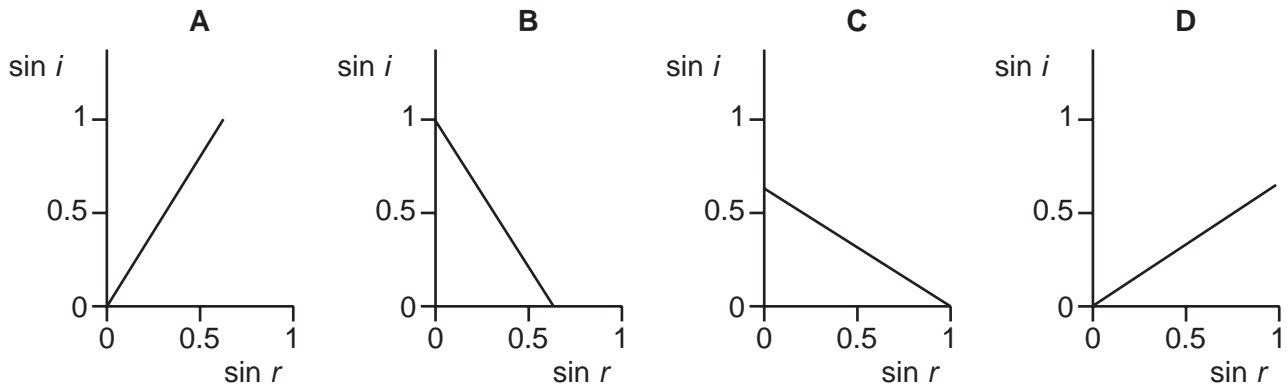

- 22 A boy stands beside a girl in front of a large plane mirror. They are both the same distance from the mirror, as shown.

Where does the boy see the girl's image?

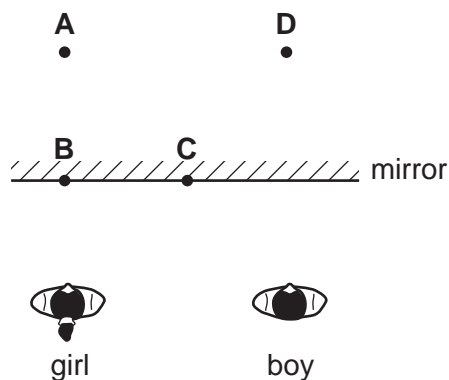

23 A student uses a spring to demonstrate waves. He moves the spring with his hand.

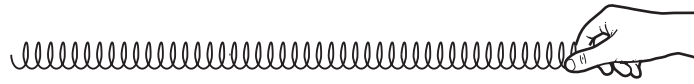

spring placed on bench

Which diagram demonstrates the type of wave produced by a source of sound?

A



B



C

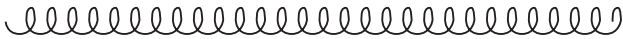

D

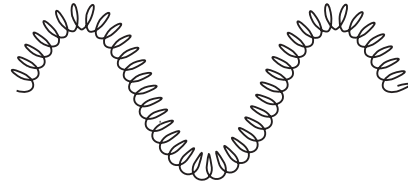

24 The diagram shows the main sections of the electromagnetic spectrum in order of increasing frequency. Some of the sections are labelled.

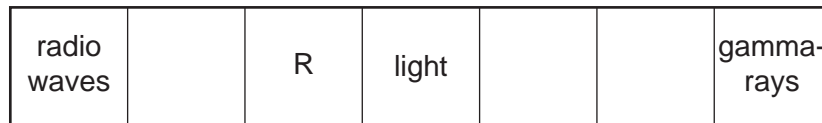

→ increasing frequency

The section R has a frequency just below that of light.

Which application uses the section R?

- A killing cancerous cells
- B satellite television
- C sterilisation
- D television remote controller

25 The diagram shows an alarm system.

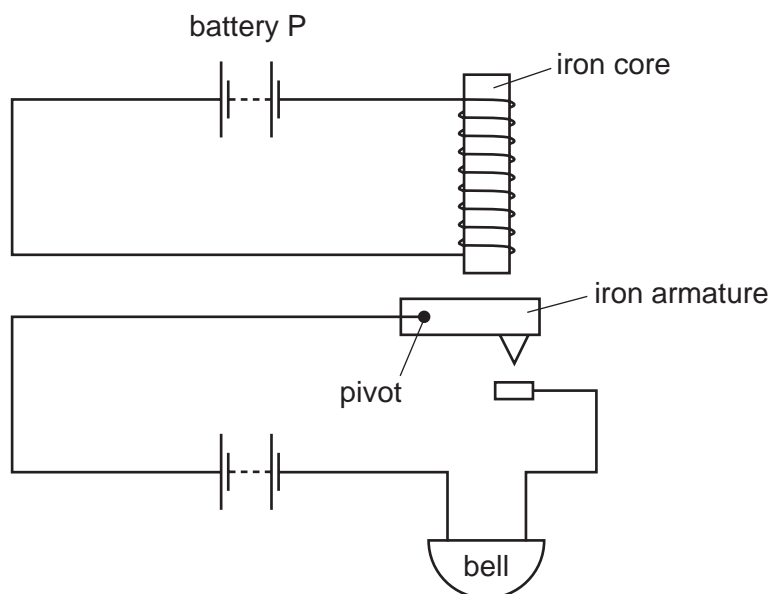

What happens when battery P is disconnected?

	iron armature	bell
<b>A</b>	falls	rings
<b>B</b>	falls	stops ringing
<b>C</b>	moves up	rings
<b>D</b>	moves up	stops ringing

26 Waveforms are shown on a cathode-ray oscilloscope for a flute and for a guitar, each playing the same note. The oscilloscope settings are the same for both waveforms.

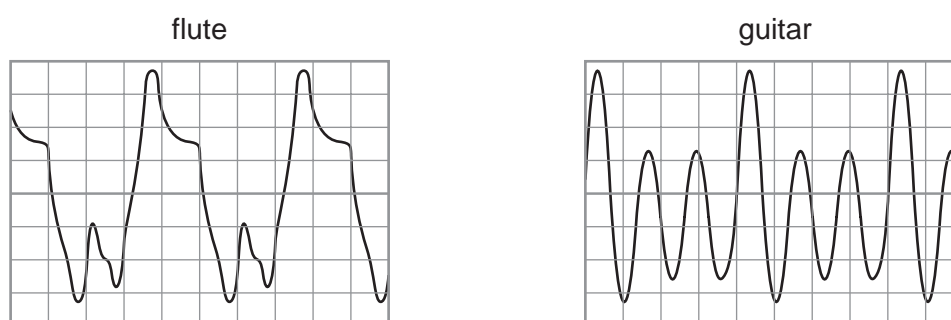

What is the difference between the two sounds?

- A** the amplitude
- B** the frequency
- C** the quality (timbre)
- D** the wavelength

- 27 Two metal spheres X and Y are on insulating bases. Both spheres are negatively charged.



Sphere X is moved towards sphere Y until they almost touch.

Which diagram shows the final pattern of charges?

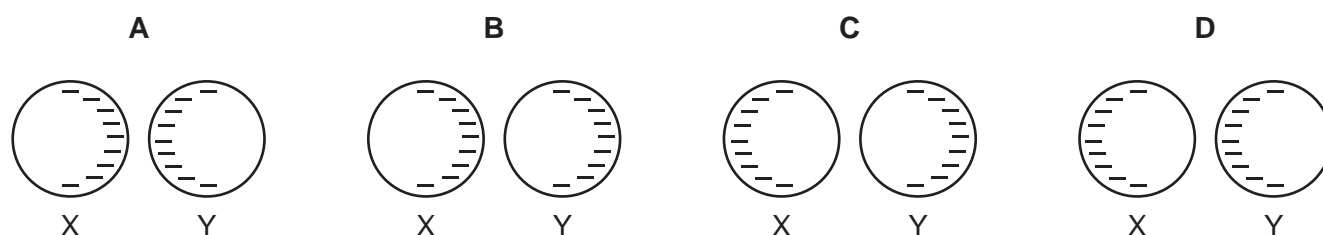

- 28 The resistance of a cylindrical wire P is  $80\ \Omega$ . A second wire Q is made from the same material. The cross-sectional area of Q is four times that of P. The length of Q is twice the length of P.

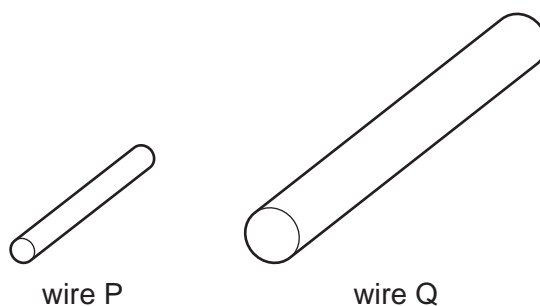

What is the resistance of Q?

- A  $10\ \Omega$       B  $40\ \Omega$       C  $160\ \Omega$       D  $640\ \Omega$

- 29 A lamp, designed to work at 1.5 V, is connected to a cell of electromotive force (e.m.f.) 1.5 V. The lamp lights at normal brightness.

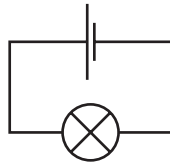

The lamp is now connected to four similar cells, each of e.m.f. 1.5 V, arranged in parallel.

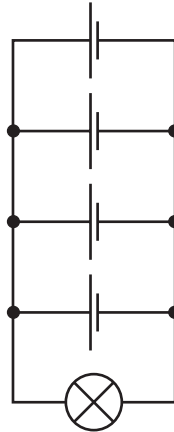

What is the effect of connecting the extra cells in this way?

- A The lamp burns out.
  - B The lamp is dimmer.
  - C The lamp produces light for a longer time.
  - D The lamp produces light for a shorter time.
- 30 The current in a filament lamp is 0.25 A when working normally. The lamp is connected to a plug and the mains a.c. supply.

When the lamp is switched on, it does not light.

What is a possible cause for this?

- A The earth wire in the plug is not connected.
- B The fuse in the plug is 3 A.
- C The lamp only works on a d.c. power supply.
- D The live wire in the plug is not connected.

31 Which appliance used on a 240V supply is **most** likely to burn out its fuse?

	appliance	fuse
<b>A</b>	100W lamp	1 A
<b>B</b>	1 kW vacuum cleaner	5 A
<b>C</b>	2 kW fan heater	3 A
<b>D</b>	3 kW electric fire	13 A

32 The diagram shows a potential divider system of two resistors connected to a 6.0V power supply.

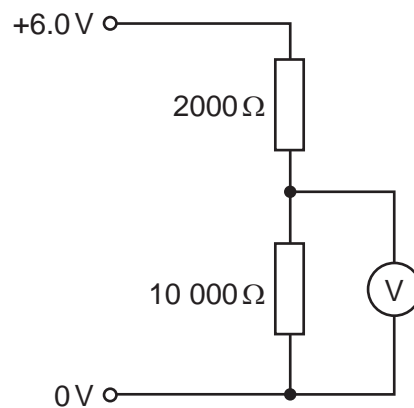

What is the reading on the voltmeter?

- A** 1.0V      **B** 1.2V      **C** 3.0V      **D** 5.0V

33 In the circuit shown, the alarm bell will only start ringing some time after the switch is closed.

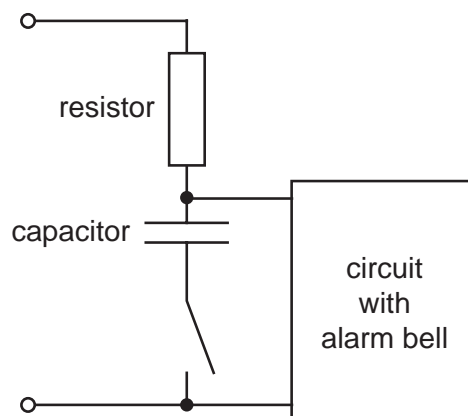

What causes the time delay?

- A** the capacitor charging  
**B** the capacitor discharging  
**C** the resistor cooling down  
**D** the resistor heating up

34 Two parallel wires carry currents in the same direction.

Which diagram shows the magnetic field around each wire and the direction of the force on each wire?

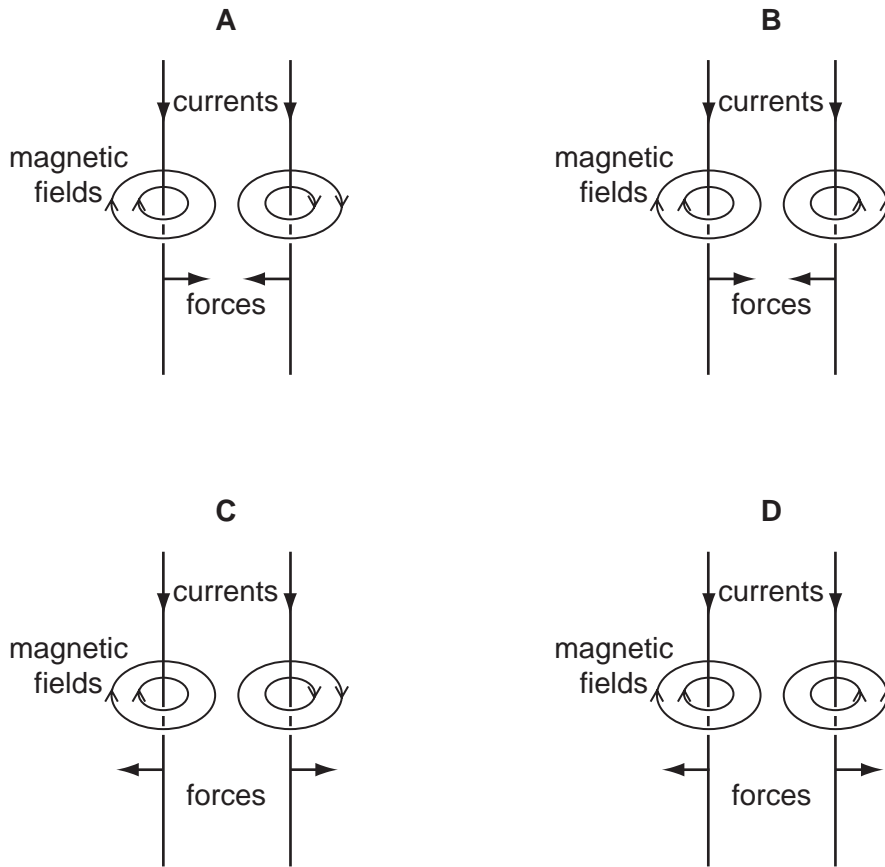

35 The diagrams show three electrical devices, X, Y and Z.

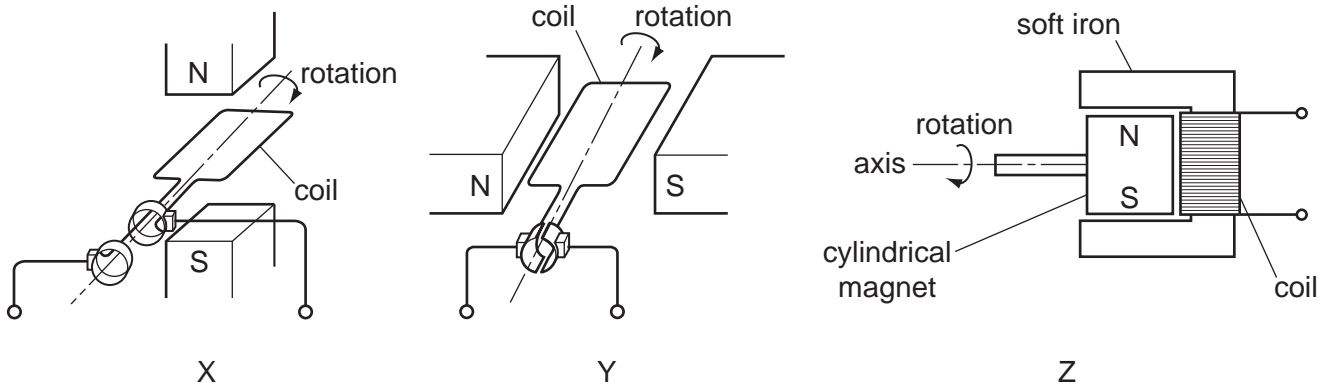

Which devices provide an alternating current (a.c.) output?

- A** X only      **B** Y only      **C** X and Y      **D** X and Z

36 One component of a simple d.c. motor is a split-ring commutator.

Which metal is used to make the commutator, and why is this metal chosen?

	metal	reason
<b>A</b>	copper	it is a good conductor of electricity
<b>B</b>	copper	it is a good conductor of heat
<b>C</b>	iron	it increases the magnetic field strength
<b>D</b>	iron	it is attracted to the brushes

37 A small coil is connected to a galvanometer G, as shown.

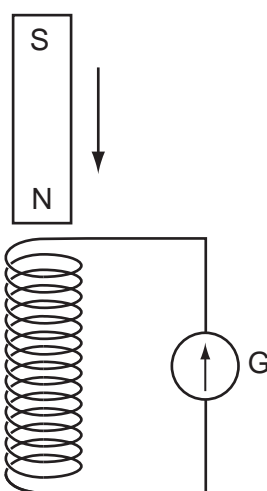

When a magnet is allowed to fall towards the coil, the galvanometer pointer gives a momentary deflection to the right of the zero position.

The magnet moves through the coil.

What happens to the galvanometer pointer as the magnet falls away from the coil?

- A** It gives a continuous reading to the left.
- B** It gives a momentary deflection to the left.
- C** It gives a continuous reading to the right.
- D** It gives a momentary deflection to the right.



38 One isotope of carbon is  $^{14}_6\text{C}$ .

How many neutrons and protons does each atom of this isotope contain?

	number of neutrons	number of protons
<b>A</b>	6	6
<b>B</b>	6	8
<b>C</b>	8	6
<b>D</b>	14	6

39 The isotope barium-140 has a half-life of 13 days. A sample of this isotope is kept for 13 days.

Which quantity halves during this time?

- A** the number of atoms of barium-140 in the sample
- B** the number of electrons in an atom of barium-140
- C** the number of nucleons in an atom of barium-140
- D** the number of protons in a nucleus of barium-140

40 In a laboratory experiment, particles from a radioactive source are deviated by a magnetic field and reach a detector.

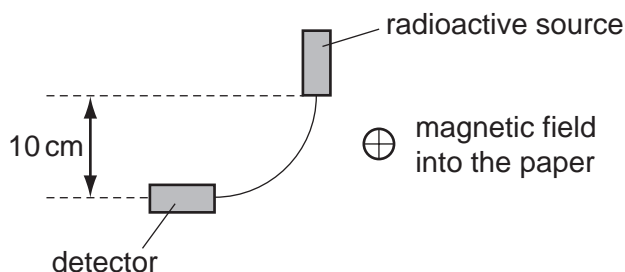

Which particles are deviated and reach the detector?

- A** alpha-particles and gamma-rays
- B** alpha-particles only
- C** beta-particles and gamma-rays
- D** beta-particles only





**BLANK PAGE**

---

Permission to reproduce items where third-party owned material protected by copyright is included has been sought and cleared where possible. Every reasonable effort has been made by the publisher (UCLES) to trace copyright holders, but if any items requiring clearance have unwittingly been included, the publisher will be pleased to make amends at the earliest possible opportunity.

University of Cambridge International Examinations is part of the Cambridge Assessment Group. Cambridge Assessment is the brand name of University of Cambridge Local Examinations Syndicate (UCLES), which is itself a department of the University of Cambridge.