



UNIVERSITY OF CAMBRIDGE INTERNATIONAL EXAMINATIONS
General Certificate of Education Ordinary Level

PHYSICS

5054/12

Paper 1 Multiple Choice

October/November 2010

1 hour

Additional Materials: Multiple Choice Answer Sheet
Soft clean eraser
Soft pencil (type B or HB is recommended)



READ THESE INSTRUCTIONS FIRST

Write in soft pencil.

Do not use staples, paper clips, highlighters, glue or correction fluid.

Write your name, Centre number and candidate number on the Answer Sheet in the spaces provided unless this has been done for you.

There are **forty** questions on this paper. Answer **all** questions. For each question there are four possible answers **A, B, C** and **D**.

Choose the **one** you consider correct and record your choice in **soft pencil** on the separate Answer Sheet.

Read the instructions on the Answer Sheet very carefully.

Each correct answer will score one mark. A mark will not be deducted for a wrong answer.

Any rough working should be done in this booklet.

This document consists of **15** printed pages and **1** blank page.



1 Which list contains only scalar quantities?

- A acceleration, displacement, velocity
- B distance, force, speed
- C force, length, time
- D length, mass, speed

2 A small stone is dropped from the top of a ladder, falls and hits the ground. It does not rebound.

Which speed-time graph is correct?

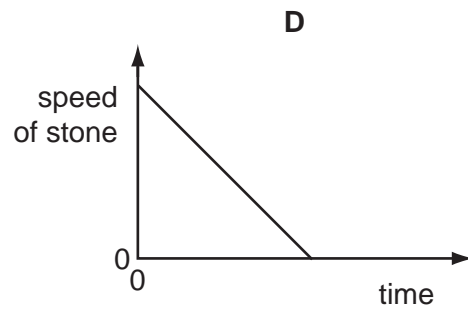
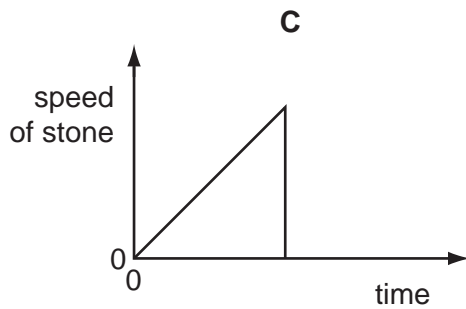
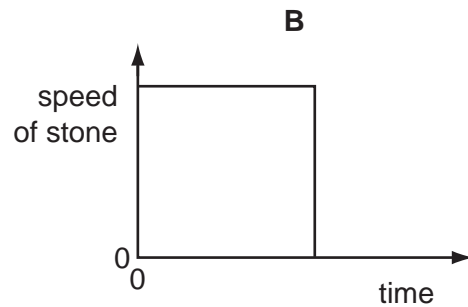
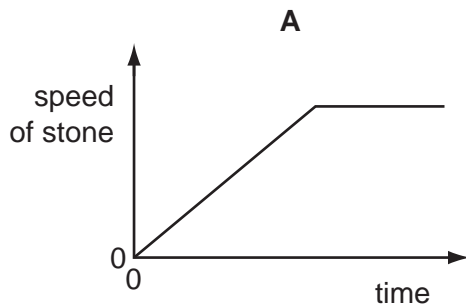

3 A car travels along a road. The driver stops the car by pushing his foot down on the brake pedal.

What does **not** change if he pushes harder on the brake pedal?

- A the braking distance
- B the braking force
- C the stopping distance
- D the thinking distance

- 4 Vernier calipers are shown with the jaws closed.

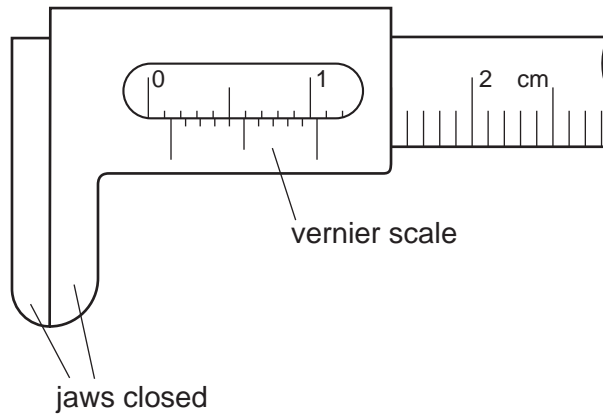

What is the zero error?

- A 0.04 cm B 0.05 cm C 0.14 cm D 0.15 cm
- 5 A student pulls a piece of tape through a ticker-tape timer. Every 0.02 s, the timer prints a dot on the tape.

First the tape is pulled quickly, then slowly, then quickly again.

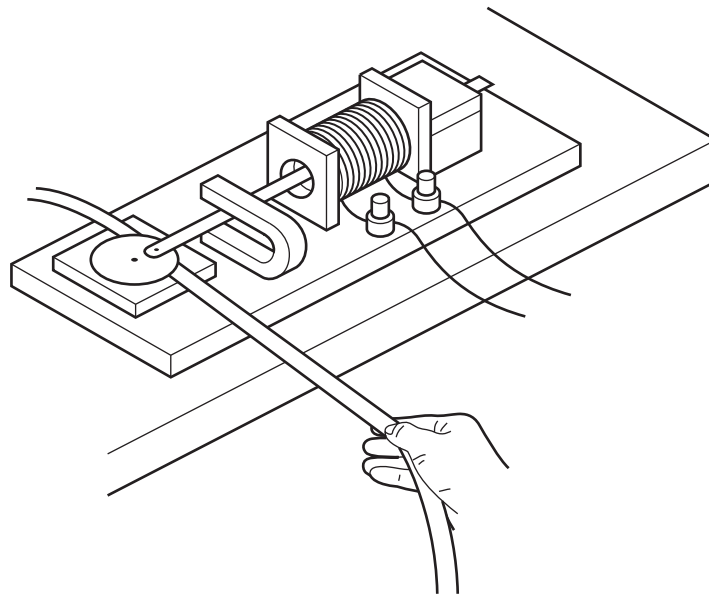

Which piece of tape does the student obtain?

- A
- B
- C
- D

- 6 An aircraft, flying at a constant height, is gaining speed.

The four forces acting are

- L lift due to the wings
- R air resistance
- T the thrust due to the engines
- W the weight

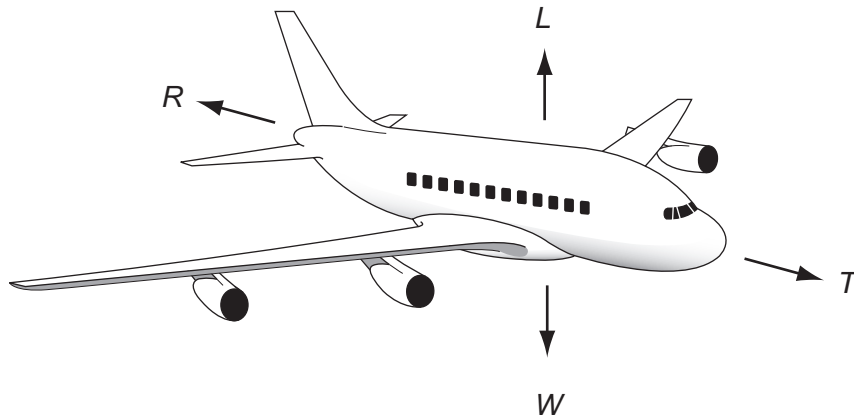

Which row is correct?

	vertical forces	horizontal forces
A	$L = W$	$T = R$
B	$L > W$	$T > R$
C	$L = W$	$T > R$
D	$L > W$	$T = R$

- 7 The base for a statue rests on level ground. It is made from stone and is 2.0 m long, 2.5 m high and 0.80 m wide. It has a weight of 96 000 N.

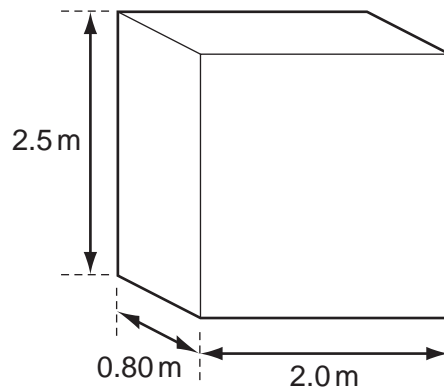

What is the pressure that the base exerts on the ground?

- A** 19 kPa **B** 24 kPa **C** 48 kPa **D** 60 kPa

8 What affects the stability of an object?

- A only its base area
- B only its base area and the location of its centre of mass
- C only its weight and its base area
- D only the location of its centre of mass

9 A person of weight 600 N at the bottom of a mountain climbs to the top. The gravitational field strength changes from 10.00 N/kg at the bottom to 9.97 N/kg at the top. His mass is unchanged as he climbs.

What are his mass and his weight at the top of the mountain?

	mass at top of mountain / kg	weight at top of mountain / N
A	60.0	598
B	60.0	600
C	60.1	598
D	60.1	600

10 An engineer designs a dam wall for a reservoir.

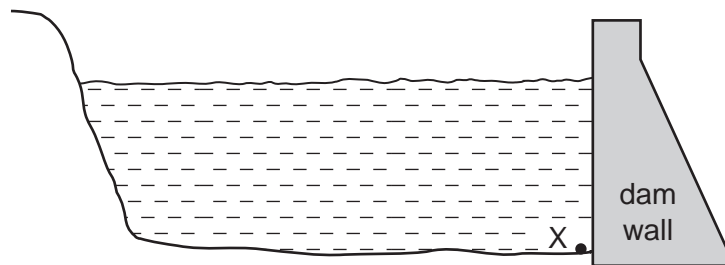

Which factor determines the pressure at X?

- A the depth of the water in the reservoir
- B the surface area of the reservoir
- C the length of the reservoir
- D the thickness of the dam wall

- 11 A box has an internal volume of 1000 cm^3 . When a solid object is placed in the closed box, the volume of air in the box is 520 cm^3 .

The density of the object is 8.00 g/cm^3 .

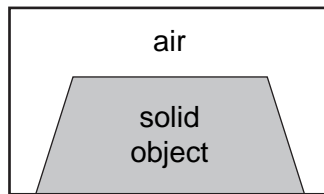

What is the mass of the object?

- A 60.0g B 3840g C 4160g D 8000g
- 12 A uniform metre rule is balanced by a 4 N weight as shown in the diagram.

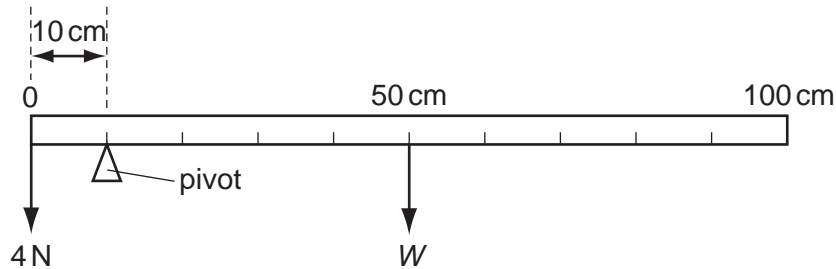

What is the weight W of the metre rule?

- A 1 N B 4 N C 16 N D 40 N
- 13 The tubes inside solar heating panels use the Sun's radiation to warm water.

Why are the tubes painted black?

- A Black surfaces absorb radiation well.
 B Black surfaces conduct heat well.
 C Black surfaces emit radiation well.
 D Black surfaces reflect radiation well.
- 14 A liquid evaporates rapidly.
- Why does this cause it to cool?
- A Air molecules remove heat by contact with the liquid surface.
 B Energy is lost by convection currents.
 C Some of the most energetic molecules leave the liquid.
 D The molecules have less room to move around.

- 15 A hot liquid is poured into a beaker. The graph shows how its temperature changes as it cools towards room temperature.

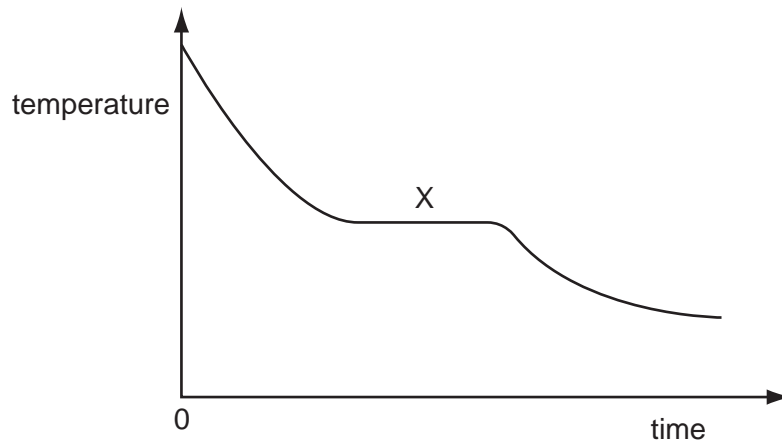

Which processes are taking place at region X?

- A boiling and evaporation
 - B condensation only
 - C evaporation only
 - D solidification and evaporation
- 16 What is caused by the thermal expansion of a substance when heated?
- A a decrease in the resistance of a tungsten-filament lamp when switched on
 - B a rise in the pressure of the gas trapped in a gas cylinder placed in hot water
 - C the blowing of the fuse in a circuit when the current becomes too large
 - D the upward movement of the air above a Bunsen burner when it is lit
- 17 The diagram shows a clinical thermometer.

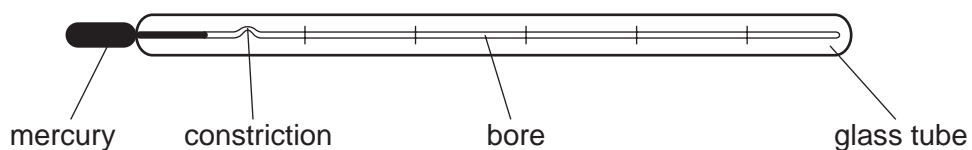

Which factor affects the sensitivity of the thermometer?

- A the constriction
- B the diameter of the bore
- C the length of the glass tube
- D the thickness of the glass tube

18 The energy output of a generator depends on its efficiency and the energy input.

Which set of values is correct?

	efficiency	energy input /MJ	energy output /MJ
A	0.1	50	25
B	0.2	30	6
C	0.4	120	30
D	0.6	60	24

19 When one radium nucleus decays, its mass decreases by 8.8×10^{-30} kg.

How much energy is equivalent to this loss in mass?

(speed of light $c = 3.0 \times 10^8$ m/s)

A 6.8×10^{-42} J **B** 2.6×10^{-21} J **C** 4.0×10^{-13} J **D** 7.9×10^{-13} J

20 The diagram shows a curved track. A ball is released from the position shown.

At which point does the ball have the maximum gravitational potential energy?

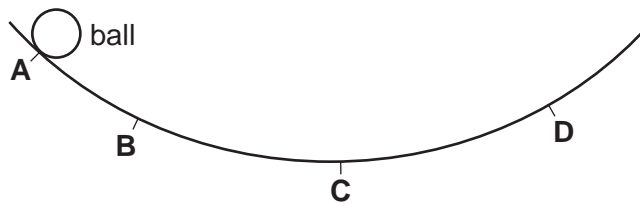

21 During a thunderstorm, there is an interval of 1.70 s between an observer seeing the lightning and hearing the thunder. The speed of sound is 340 m/s.

What is the distance between the observer and the storm?

A 100 m **B** 200 m **C** 578 m **D** 1160 m

22 Which pair of emissions travels with the same speed in air?

- A** alpha-particles and gamma-rays
- B** gamma-rays and infra-red waves
- C** infra-red waves and sound waves
- D** sound waves and alpha-particles

23 A ray of light strikes the surface of a glass block at an angle of incidence of 45° .

The refractive index of the glass is 1.5.

What is the angle of refraction inside the block?

- A 28° B 30° C 45° D 67°

24 An object is viewed through a concave (diverging) lens.

What is the correct description of the image formed?

- A real, inverted, magnified
 B real, upright, diminished
 C virtual, inverted, magnified
 D virtual, upright, diminished

25 In an experiment using a ripple tank, plane wavefronts arrive at a plane surface.

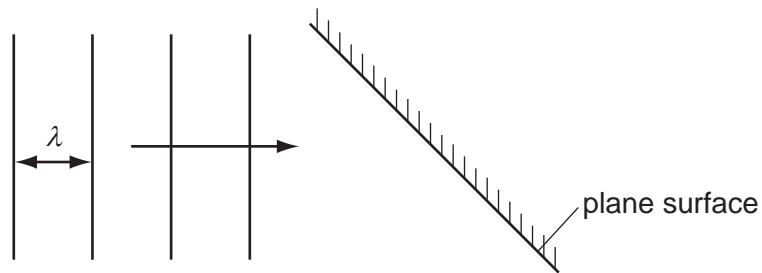

Which row correctly describes the waves after they are reflected from the surface?

	speed of waves	wavelength λ
A	faster	shorter
B	slower	shorter
C	the same	longer
D	the same	the same

26 Many electrical appliances have metal cases.

To prevent the case from becoming 'live', with the possibility of an electric shock, the earth wire of the electric cable is attached to the case.

How does the earth wire prevent an electric shock?

- A It allows a current to flow to earth, so that the appliance continues working.
- B It allows a large current to flow to earth, blowing the fuse.
- C It prevents the fuse from blowing.
- D It reduces the current to a safe level.

27 A metal ring screens a piece of equipment from a magnetic field.

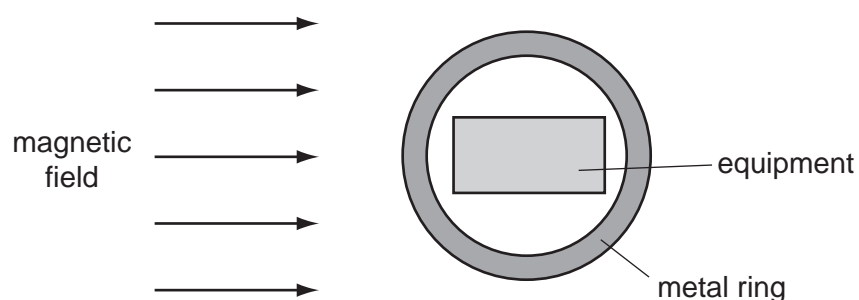

Which metal should be used for the ring, and why?

	metal	reason
A	copper	the metal carries the field lines around the equipment
B	copper	the metal is non-magnetic
C	iron	the metal carries the field lines around the equipment
D	iron	the metal is non-magnetic

28 The diagram shows a simple electric circuit.

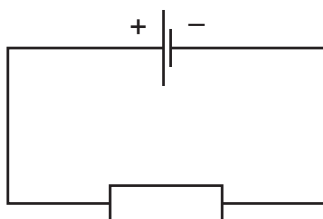

Which row describes the charge on an electron and the direction of electron flow through the resistor?

	charge on an electron	direction of electron flow
A	negative	- to +
B	negative	+ to -
C	positive	- to +
D	positive	+ to -

29 A negatively-charged sphere X is brought up to an identical uncharged sphere Y. The spheres do not touch.

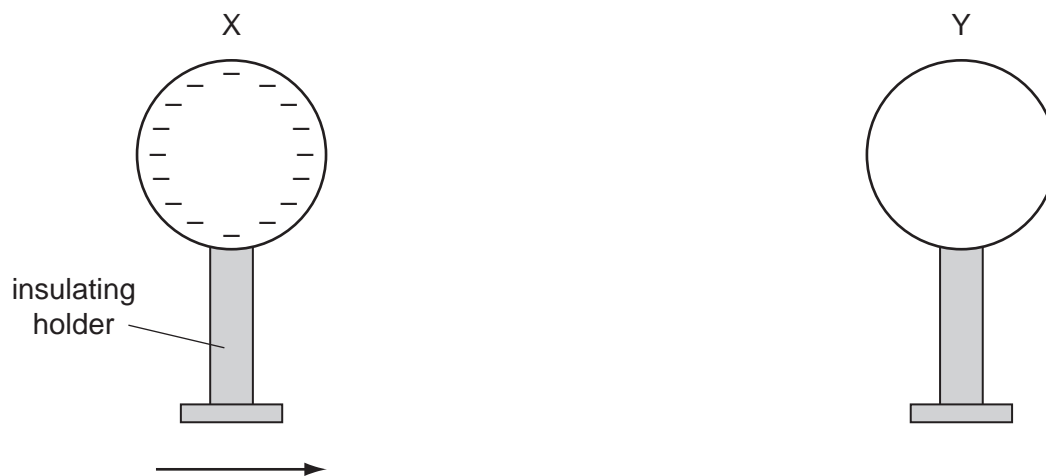

Sphere Y is 'earthed' by touching it with a finger, which is then removed. Sphere X is then moved away from sphere Y.

What is the final charge, if any, on sphere Y?

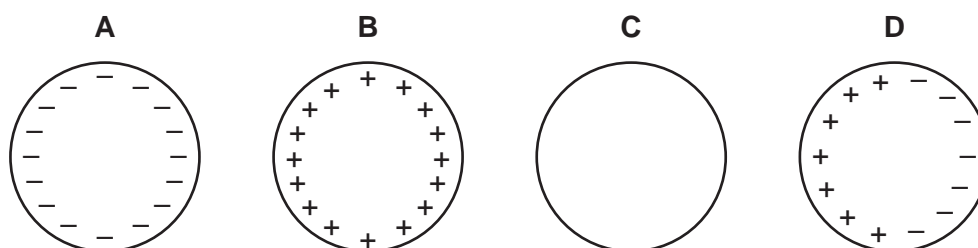

- 30 A battery is used to light a 24 W electric lamp. The battery provides a charge of 120 C in 60 s.

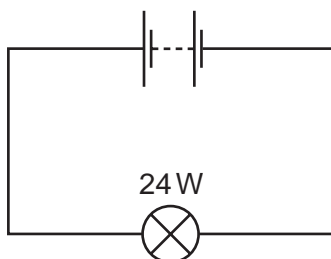

What is the potential difference across the lamp?

- A 5 V B 12 V C 24 V D 120 V
- 31 When three identical resistors are connected in series, their combined resistance is $6\ \Omega$.

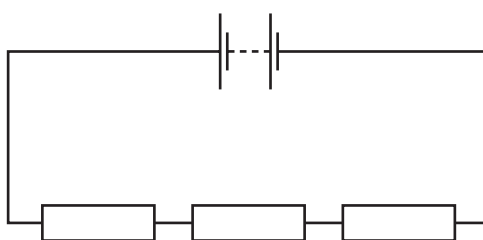

series

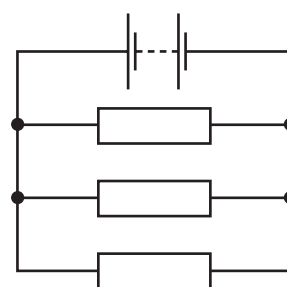

parallel

What is their combined resistance when they are connected in parallel?

- A $\frac{1}{6}\ \Omega$ B $\frac{2}{3}\ \Omega$ C $\frac{3}{2}\ \Omega$ D $6\ \Omega$
- 32 The diagram shows a beam of electrons entering a magnetic field. The direction of the magnetic field is downwards, towards the bottom of the page.

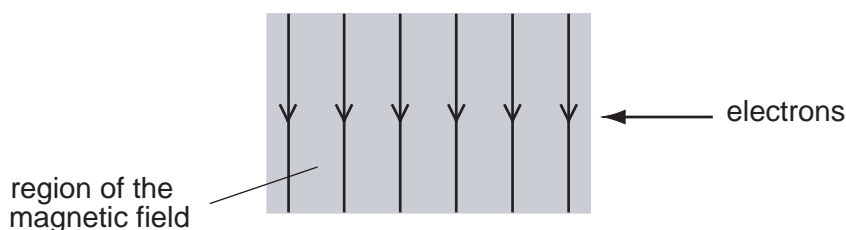

In which direction does the deflection of the electrons occur?

- A into the page
 B out of the page
 C towards the bottom of the page
 D towards the top of the page

- 33 Electric power cables transmit electrical energy over large distances using a high voltage, alternating current.

What are the advantages of using a high voltage and of using an alternating current?

	advantage of using a high voltage	advantage of using an alternating current
A	a higher current is produced in the cable	the resistance of the cable is reduced
B	a higher current is produced in the cable	the voltage can be changed using a transformer
C	less energy is wasted in the cable	the resistance of the cable is reduced
D	less energy is wasted in the cable	the voltage can be changed using a transformer

- 34 What does **not** alter the size of the turning effect on the coil of an electric motor?

- A** the direction of the current in the coil
- B** the number of turns in the coil
- C** the size of the current in the coil
- D** the strength of the magnetic field

- 35 The diagram shows an alarm system in which the switch S is shown closed.

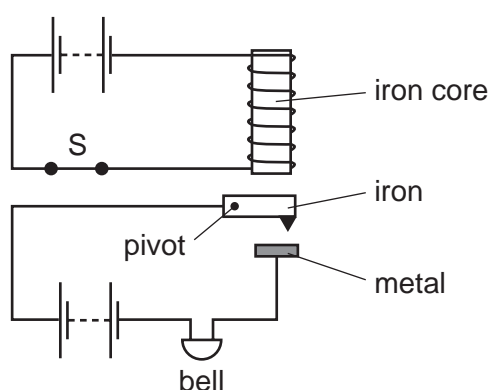

What happens when the switch S is opened?

	iron	bell
A	drops	rings
B	drops	stops ringing
C	moves up	rings
D	moves up	stops ringing

- 36 Two parallel vertical wires P and Q are a small distance apart in air. There is a downwards electric current in both wires. A force acts on Q owing to the current in P. This force is perpendicular to the wire Q.

What is the direction of the force on Q?

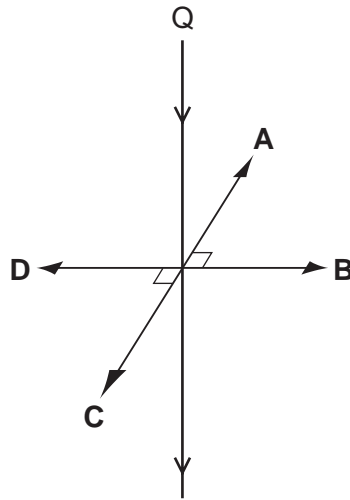

- 37 The diagram shows an a.c. generator connected to an electrical circuit (load resistor).

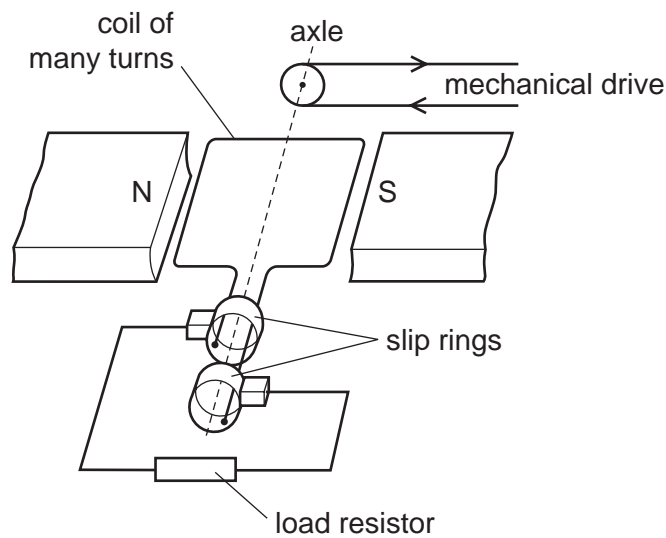

Which statement is correct?

- A The direction of the potential difference across the load resistor is always the same.
- B The size of the induced e.m.f. depends on the number of turns in the coil.
- C The size of the induced e.m.f. does not change as the coil turns.
- D Winding the coil on a soft-iron cylinder makes no difference to the induced e.m.f.

38 The table shows details of two samples of radioactive nuclides X and Y.

nuclide	number of radioactive atoms at time = 0	half-life
X	16 000	1 day
Y	2 000	2 days

After how many days will the number of atoms of nuclide X be equal to the number of atoms of nuclide Y?

- A** 2 days **B** 4 days **C** 6 days **D** 8 days

39 A student investigates a radioactive source that emits only alpha-particles. Without any source nearby, the detector shows a low reading.

The source and thick cardboard are placed near the detector, as shown.

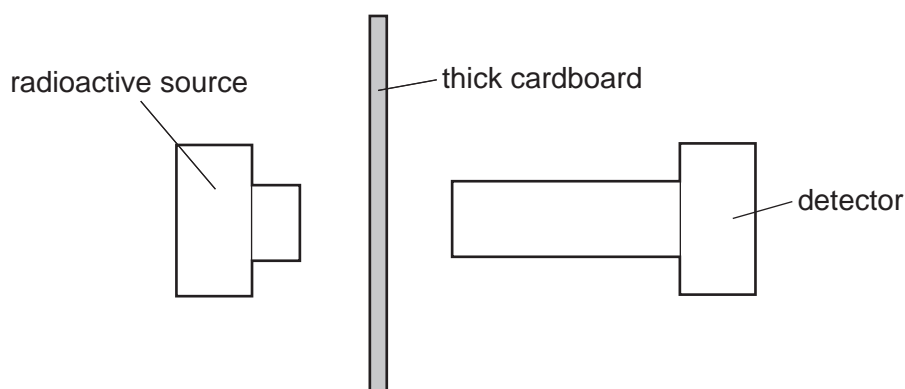

What is the reading on the detector now, and why?

	detector reading	reason
A	low	background radiation is detected
B	low	some alpha-particles pass through cardboard
C	zero	alpha-particles are all absorbed by the cardboard
D	zero	background radiation is all absorbed by the cardboard

40 $^{15}_7\text{N}$ is a nuclide of nitrogen.

How many electrons are there in a neutral atom of $^{15}_7\text{N}$?

- A** 7 **B** 8 **C** 15 **D** 22

BLANK PAGE

Permission to reproduce items where third-party owned material protected by copyright is included has been sought and cleared where possible. Every reasonable effort has been made by the publisher (UCLES) to trace copyright holders, but if any items requiring clearance have unwittingly been included, the publisher will be pleased to make amends at the earliest possible opportunity.

University of Cambridge International Examinations is part of the Cambridge Assessment Group. Cambridge Assessment is the brand name of University of Cambridge Local Examinations Syndicate (UCLES), which is itself a department of the University of Cambridge.