



UNIVERSITY OF CAMBRIDGE INTERNATIONAL EXAMINATIONS
General Certificate of Education Ordinary Level

PHYSICS

5054/01

Paper 1 Multiple Choice

October/November 2009

1 hour

Additional Materials: Multiple Choice Answer Sheet
 Soft clean eraser
 Soft pencil (type B or HB is recommended)



READ THESE INSTRUCTIONS FIRST

Write in soft pencil.

Do not use staples, paper clips, highlighters, glue or correction fluid.

Write your name, Centre number and candidate number on the Answer Sheet in the spaces provided unless this has been done for you.

There are **forty** questions on this paper. Answer **all** questions. For each question there are four possible answers **A, B, C** and **D**.

Choose the **one** you consider correct and record your choice in **soft pencil** on the separate Answer Sheet.

Read the instructions on the Answer Sheet very carefully.

Each correct answer will score one mark. A mark will not be deducted for a wrong answer.

Any rough working should be done in this booklet.

This document consists of **18** printed pages and **2** blank pages.



1 Vernier calipers read to one tenth of a millimetre.

Which reading shows this precision?

- A 3.3 cm B 3.31 cm C 3.310 cm D 3.312 cm

2 Which list contains only scalar quantities?

- A acceleration, displacement, mass
B acceleration, distance, speed
C displacement, mass, velocity
D distance, mass, speed

3 Which speed-time graph shows an object moving with non-uniform acceleration?

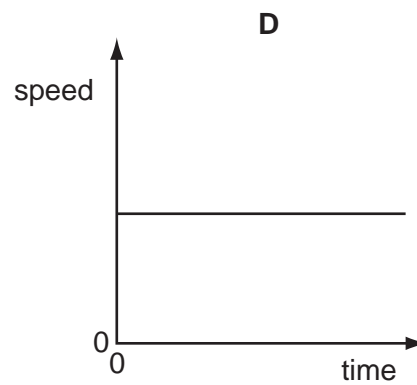
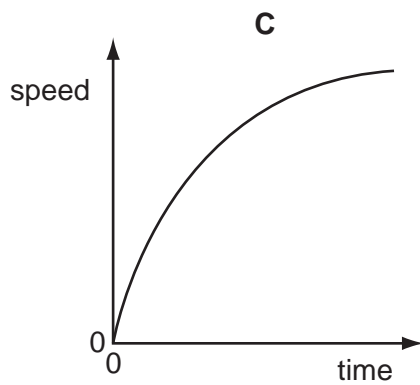
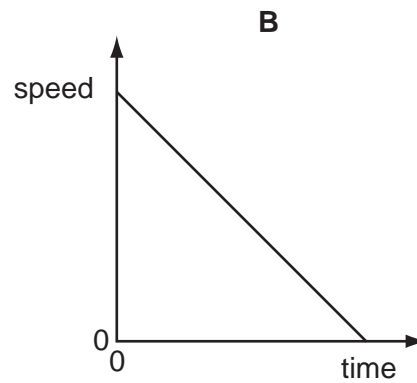
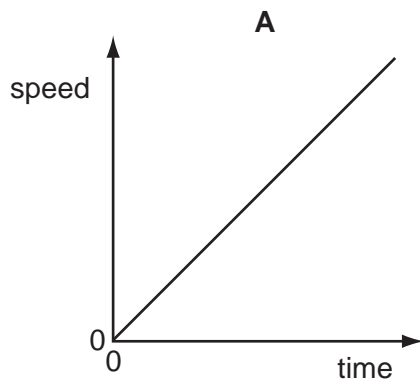

- 4 The graph shows the speed of a car as it moves from rest.

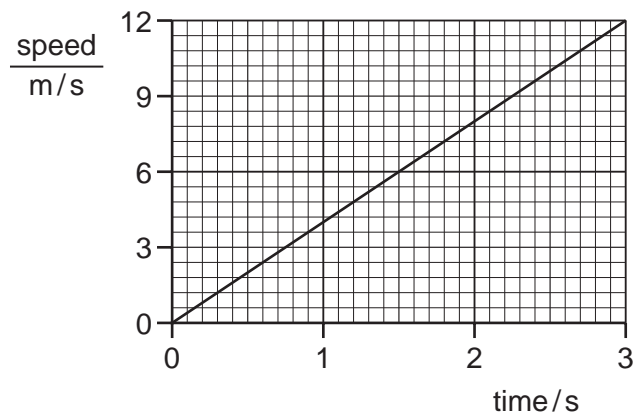

What is the average speed of the car during the first 3 s?

- A** 4 m/s **B** 6 m/s **C** 18 m/s **D** 36 m/s
- 5 A tractor pulls a trailer at a constant speed.
- The tractor exerts a forward force of 1600 N on the trailer.
- What is the force exerted by the trailer on the tractor?
- A** 0 N
B 1600 N backwards
C 1600 N forwards
D 3200 N forwards
- 6 A turntable rotates at constant speed. A coin is placed on the turntable at P. The friction force between the coin and the turntable keeps the coin in the same position on the turntable.

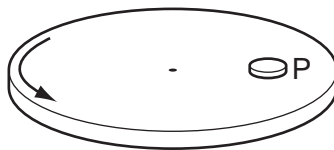

In which direction does the friction force act?

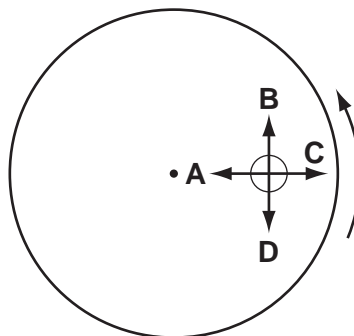

- 7 A room measures $4.0\text{ m} \times 3.0\text{ m} \times 2.0\text{ m}$. The density of the air in the room is 1.3 kg/m^3 .

What is the mass of air in the room?

- A 0.054 kg B 18 kg C 24 kg D 31 kg

- 8 The stability of a bus is tested by tilting it on a ramp. The diagram shows a bus that is just about to topple over.

Where is the centre of mass of the bus?

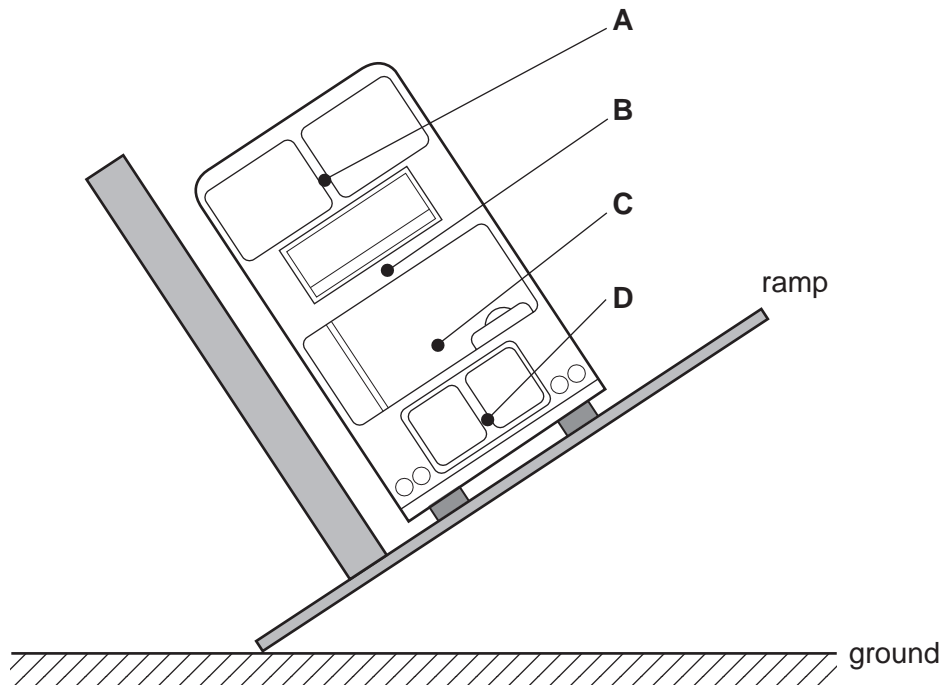

- 9 A load L is suspended from two springs that are in parallel. The extension of each spring is x .

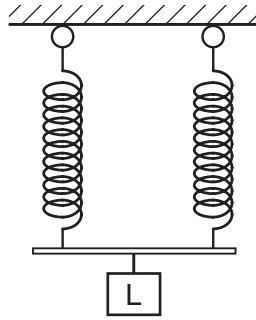

The springs are then arranged to hang vertically, one below the other.

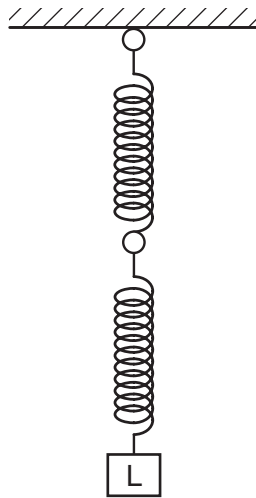

In this new arrangement, what is the total extension of the two springs?

- A** $\frac{1}{2}x$ **B** x **C** $2x$ **D** $4x$

- 10 A long tube full of mercury is inverted in a small dish of mercury.

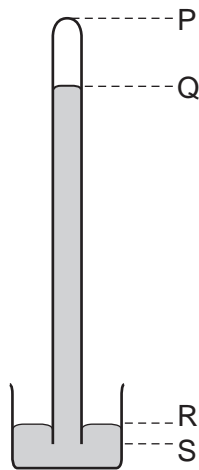

The mercury level in the tube falls, leaving a vacuum at the top.

When the atmospheric pressure falls, which length decreases?

- A** PQ **B** PS **C** QR **D** RS
- 11 Some gas is trapped in a large syringe by a piston. The atmospheric pressure is 100 kPa.

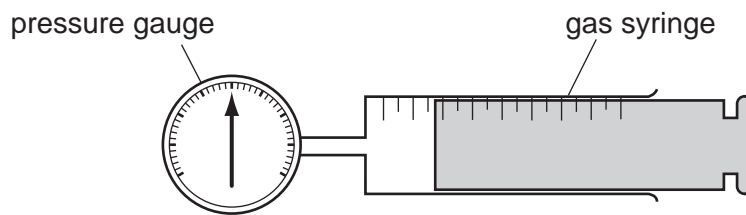

The pressure gauge indicates that the gas pressure is 200 kPa above atmospheric pressure. The piston moves outwards and the volume of the trapped gas doubles. The temperature remains constant.

What is the new gas pressure?

- A** 100 kPa **B** 150 kPa **C** 200 kPa **D** 400 kPa

12 The diagram shows energy transfer through a machine.

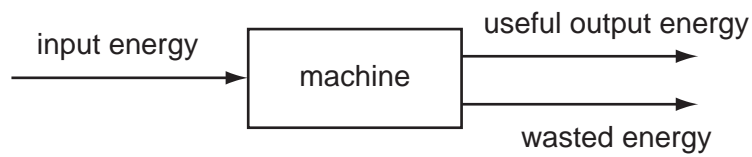

What is the efficiency of the machine?

- A** $\frac{\text{input energy}}{\text{useful output energy}}$
- B** $\frac{\text{useful output energy}}{\text{input energy}}$
- C** $\frac{\text{useful output energy}}{\text{wasted energy}}$
- D** $\frac{\text{wasted energy}}{\text{input energy}}$

13 A man weighs 600 N. He runs up a staircase of total height 4.0 metres in 3.0 seconds.

How much useful power is needed to do this?

- A** 450 W **B** 800 W **C** 2400 W **D** 7200 W

- 14 The diagrams show four cans in a cool room. They are painted as shown. One pair is filled with hot water and left to cool down. The other pair is filled with cold water and placed near infra-red heaters.

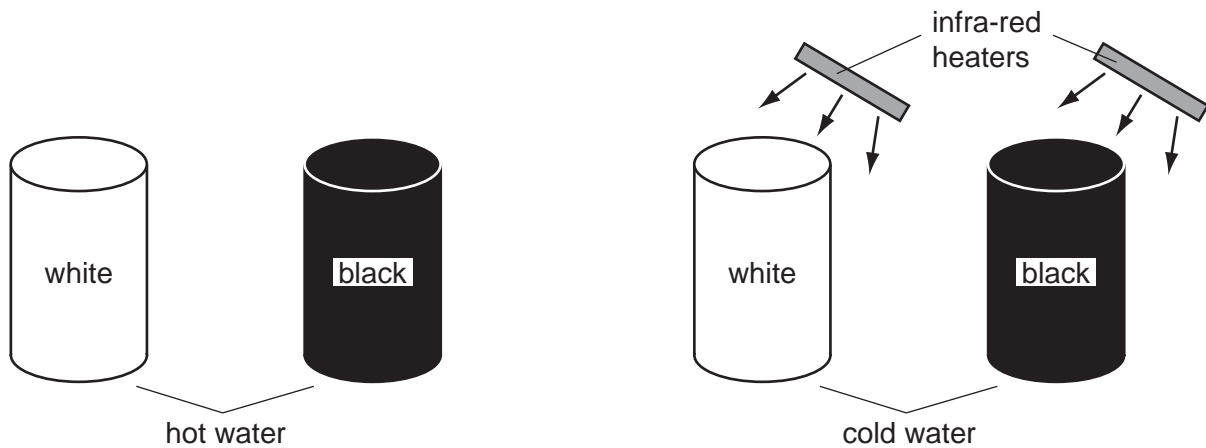

The hot water in the black can cools more quickly than the hot water in the white can. The cold water in the black can heats up more quickly than the cold water in the white can.

Which row shows the reasons for this?

	better emitter of infra-red	better absorber of infra-red
A	black	black
B	black	white
C	white	black
D	white	white

- 15 To calibrate a thermometer, without using another thermometer, fixed points are required.

Which statement is correct?

- A** Any temperatures can be used as fixed points.
B Both a lower fixed point and an upper fixed point are required.
C Only a lower fixed point is required.
D Only an upper fixed point is required.
- 16 A block of metal has a mass of 2.0 kg. Its specific heat capacity is $800 \text{ J}/(\text{kg } ^\circ\text{C})$.

The block is supplied with 2400 J of energy.

What is the rise in temperature?

- A** 0.17°C **B** 0.67°C **C** 1.5°C **D** 6.0°C

- 17 A quantity of gas is trapped in a container by a piston exerting a force F .

The temperature of the gas is raised while F remains unchanged.

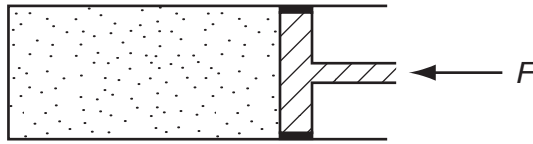

Which statement is correct?

- A The gas expands.
 - B The molecules get larger.
 - C The piston remains in the same place.
 - D The speed of the molecules decreases.
- 18 The diagram shows a cross-section through a rain-water puddle formed in a shallow depression in a road surface.

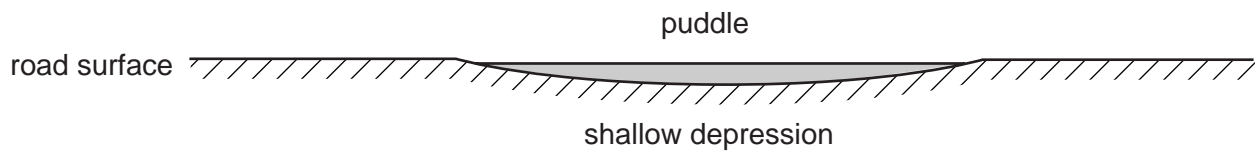

Over a period of time, the air temperature, wind speed and wind direction all remain constant.

What happens to the rate of evaporation of water from the puddle?

- A It decreases, because the surface area decreases.
- B It increases, because the puddle gets shallower.
- C It increases, because the surface area decreases.
- D It remains constant.

19 The diagram shows a ball floating in a tank of water.

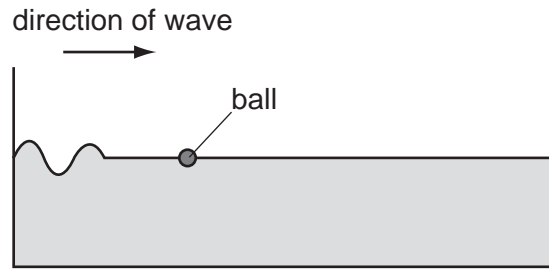

Which diagram shows the movement of the ball as the wave passes?

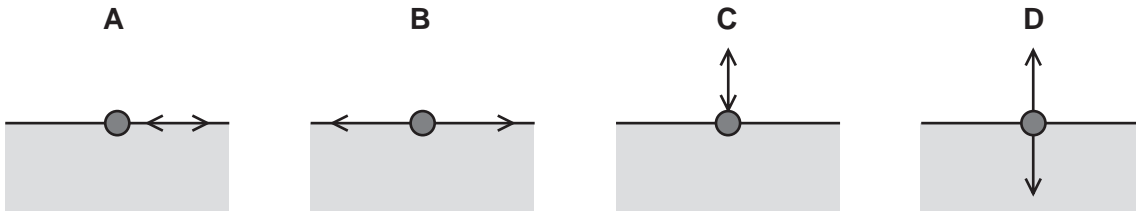

20 The diagram shows a ray of light from one point on a lamp striking a plane mirror.

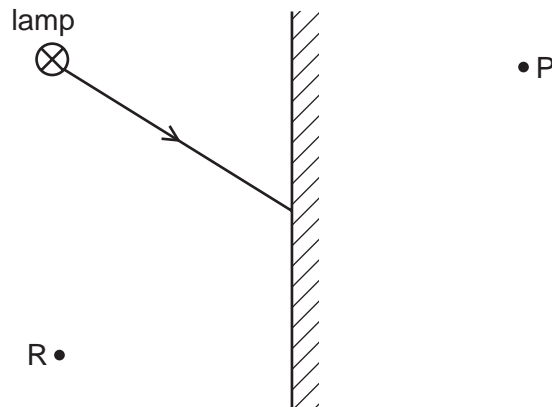

The image of the point on the lamp formed by the mirror is

- A at P and is real.
- B at P and is virtual.
- C at R and is real.
- D at R and is virtual.

21 The diagram shows the passage of a ray of light through a triangular glass block.

What is the critical angle of light in glass?

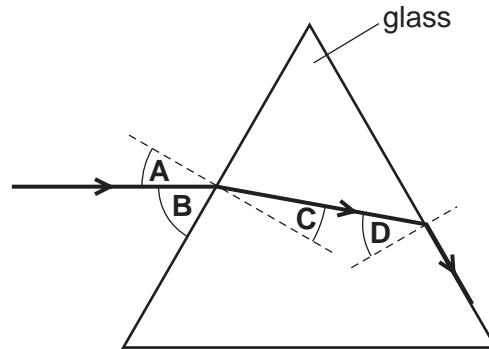

22 An object is placed in front of a diverging lens as shown on the scale diagram.

The principal focus F is marked on each side of the lens.

What is the position of the image formed by the lens?

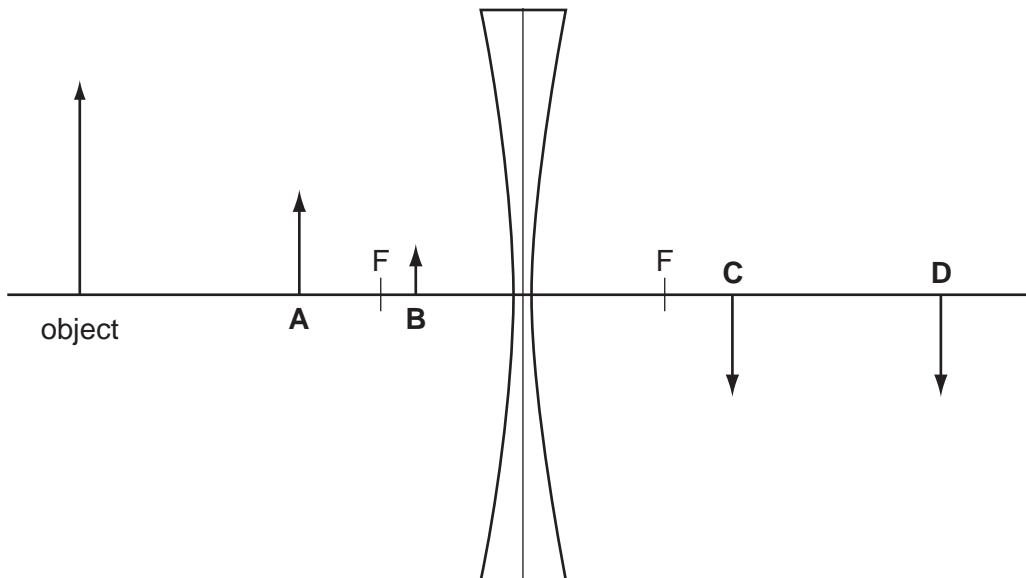

23 The diagram shows the trace produced on a cathode-ray oscilloscope (c.r.o.) by a sound.

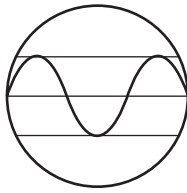

Which trace is produced when both the loudness and the pitch of the sound are increased?

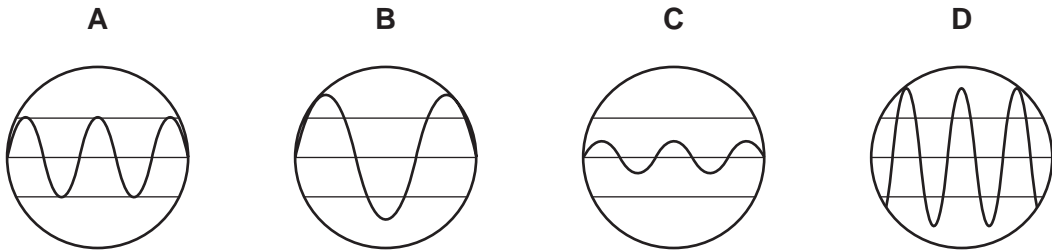

24 Which row describes the ease with which iron or steel can be magnetised and demagnetised?

	metal	magnetised	demagnetised
A	iron	difficult	easy
B	iron	easy	difficult
C	steel	difficult	difficult
D	steel	easy	easy

25 A negatively-charged rod is brought close to an isolated T-shaped piece of metal.

Initially, the metal is uncharged.

Which diagram shows the induced charge on the metal?

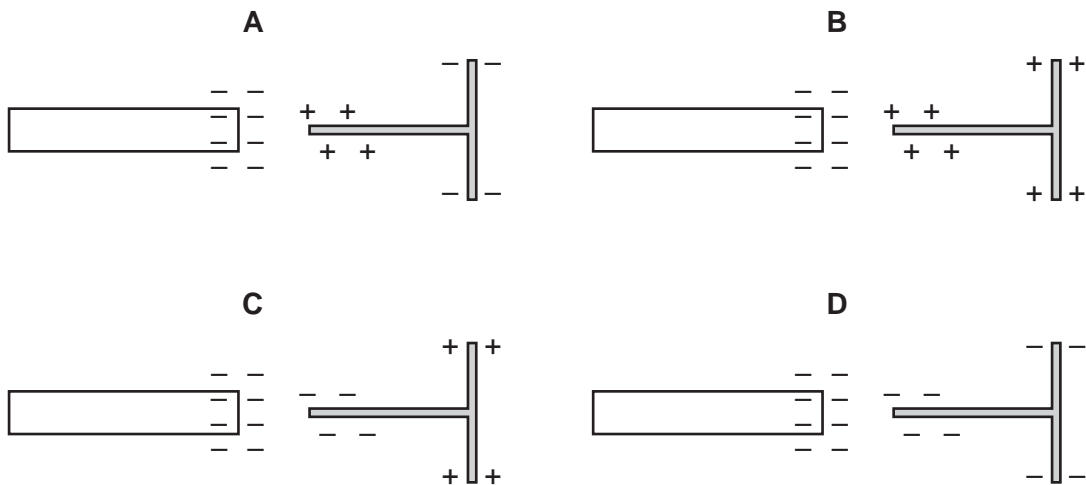

- 26 The circuit diagram shows three resistors in parallel with a battery.

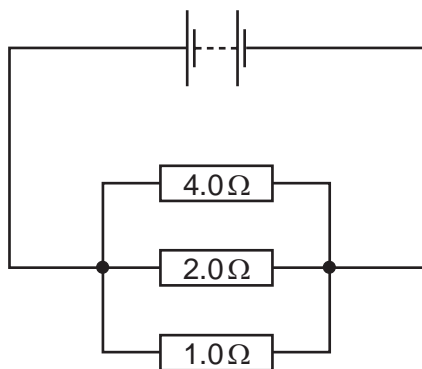

What is the effective resistance of these three resistors?

- A 0.57 Ω B 0.86 Ω C 1.75 Ω D 7.00 Ω
- 27 Ohm's law states that the current in a conductor is proportional to the potential difference across it, provided that a certain quantity remains constant.

What is this quantity?

- A length
 B pressure
 C temperature
 D thickness
- 28 Two resistors of 6 Ω and 12 Ω are arranged in parallel. A potential difference is connected across the terminals X and Y. The current in the 6 Ω resistor is 4 A.

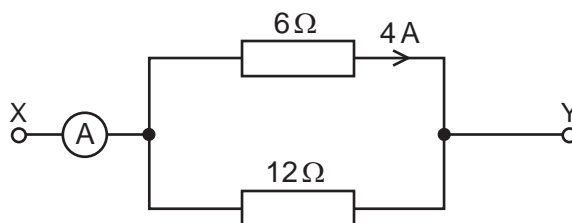

What is the current in the ammeter?

- A 4 A B 6 A C 8 A D 12 A

29 The diagram shows a standard mains plug.

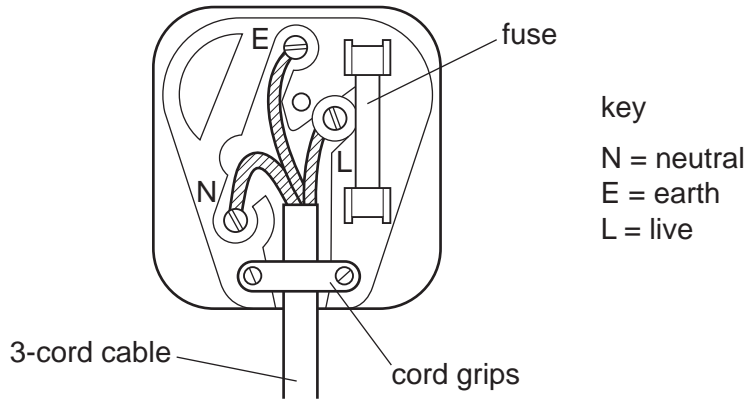

What are the correct colours for the wires?

	N	E	L
A	blue	brown	green and yellow
B	blue	green and yellow	brown
C	brown	green and yellow	blue
D	green and yellow	brown	blue

30 Which costs the **most** if operated from the same mains supply?

- A** a 5000W electric cooker used for 1 minute
- B** a 1000W electric fire used for 10 minutes
- C** a 500W electric iron used for 1 hour
- D** a 100W lamp used for 1 day

31 Each diagram shows a cross-section through two parallel conductors, each carrying an electric current.

In the conductor on the left, the current is into the page; on the right, it is out of the page.

Which diagram shows the directions of the forces on the two conductors?

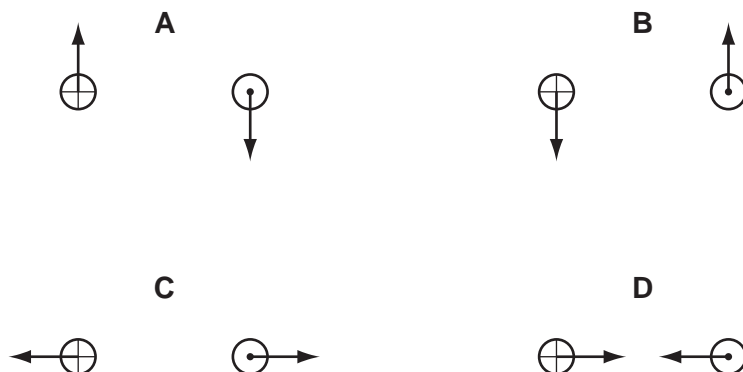

- 32 A simple model of a d.c. motor is made. By mistake, the split-ring commutator is left out. The coil can turn, but is always connected to the battery in the same way.

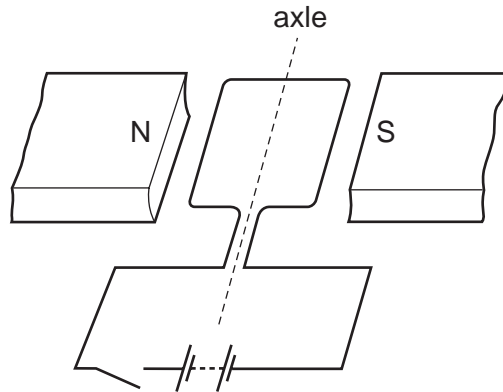

The coil starts in the horizontal position.

What happens to the coil when the circuit is switched on?

- A It does not move at all.
 - B It moves upwards, out of the magnetic field.
 - C It turns to the vertical position and eventually stops there.
 - D It turns to the vertical position then comes back to the horizontal position.
- 33 A magnet is pushed horizontally towards a coil of wire, inducing an e.m.f. in the coil.

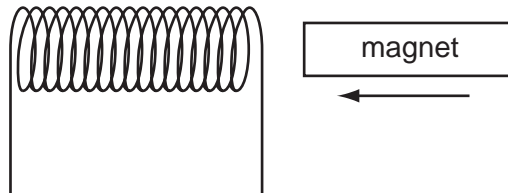

In which direction does the induced e.m.f. make the coil move?

- A away from the magnet
- B towards the magnet
- C downwards
- D upwards

- 34 The graph shows the output of an a.c. generator. The coil in the generator rotates 20 times in one second.

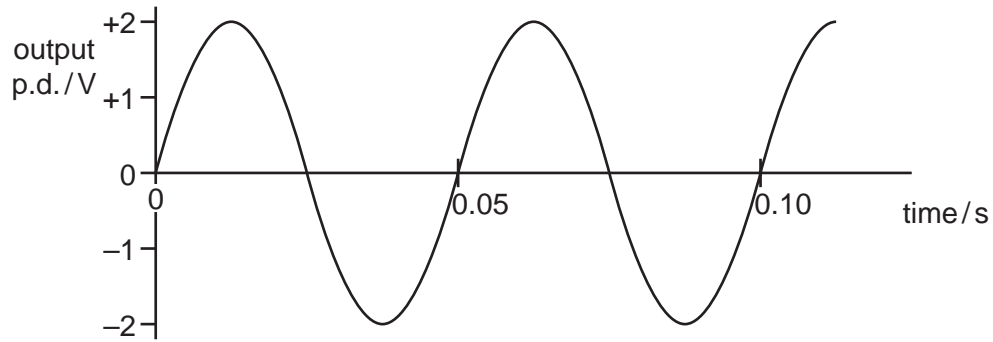

Which graph shows the output when the coil rotates 10 times in one second?

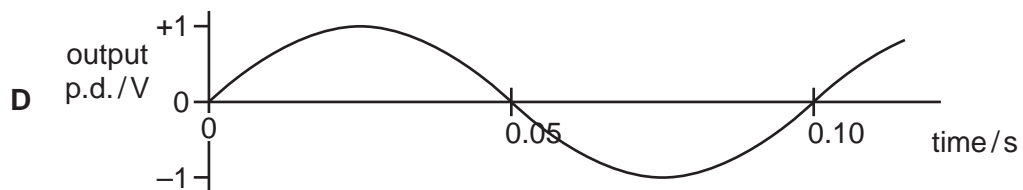
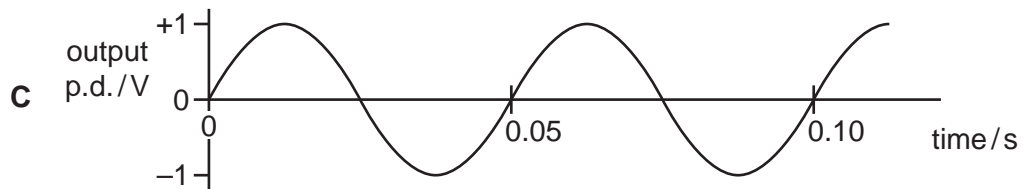
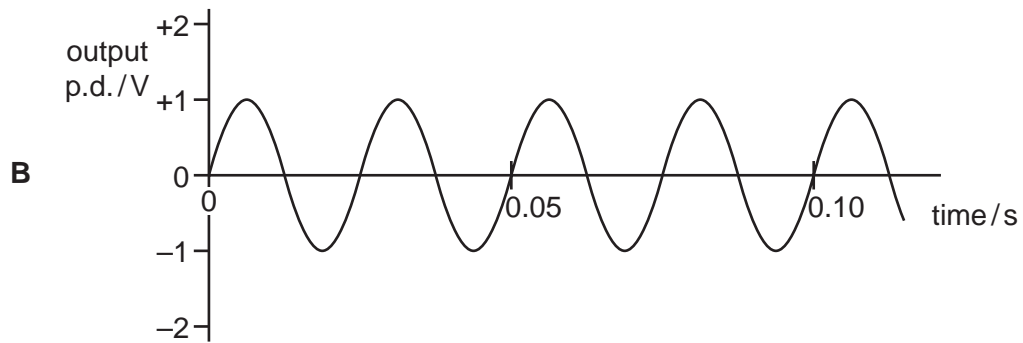
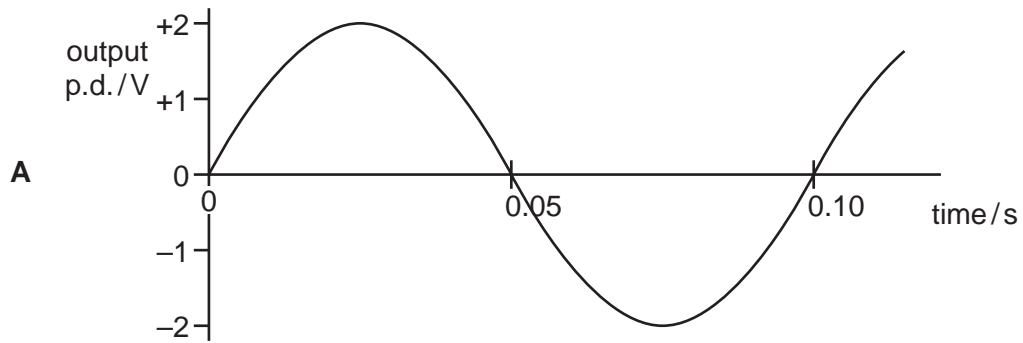

- 35 Why is a transformer used to connect a generator in a power station to a long-distance transmission line?
- A to decrease the voltage and decrease the current
 - B to decrease the voltage and increase the current
 - C to increase the voltage and decrease the current
 - D to increase the voltage and increase the current

36 The diagram is a circuit designed to switch on a lamp when it gets dark.

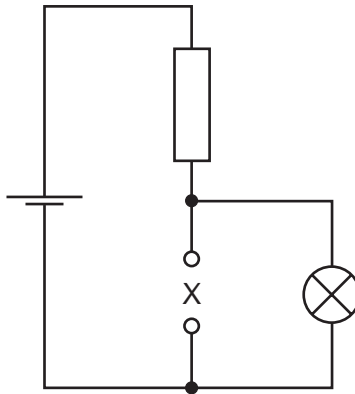

Which component is used as the sensor at X?

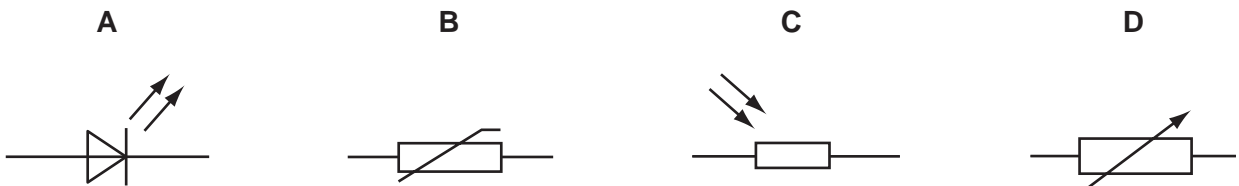

37 A thermistor is connected in a circuit with a 6 V battery, a 3000 Ω resistor and a voltmeter, as shown. The graph shows how the resistance of the thermistor varies with temperature.

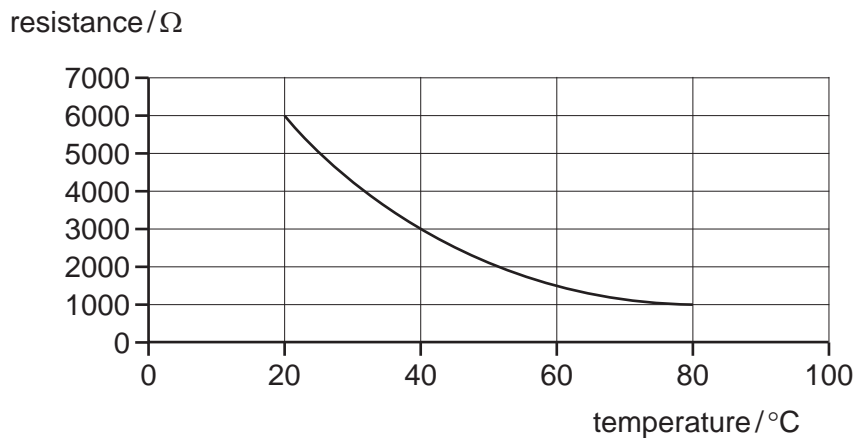
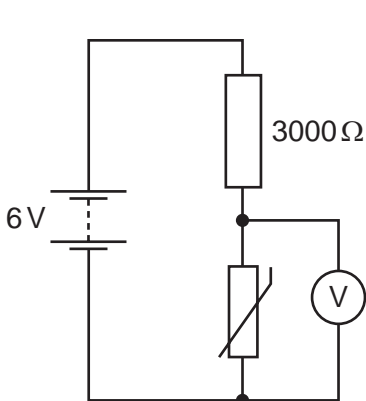

What is the temperature of the thermistor when the voltmeter reads 2V?

- A 20 °C
- B 40 °C
- C 60 °C
- D 80 °C

- 38 The activity of a radioactive source is measured over a period of time. The graph shows the decay curve.

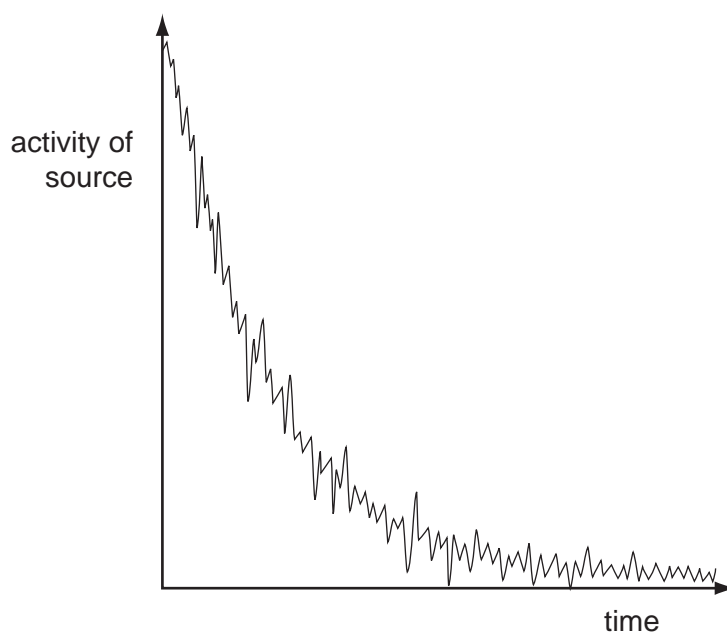

Why is the curve **not** smooth?

- A Background radiation has not been subtracted.
 B Radioactive decay is a random process.
 C The half-life is not constant.
 D The temperature is changing.
- 39 A radioactive isotope has a half-life of 6000 years.
 How much time passes before the rate of emission from a sample of this isotope falls to $\frac{1}{16}$ of its original value?
- A 6000 years
 B 18 000 years
 C 24 000 years
 D 96 000 years
- 40 A nuclide of strontium is represented by the symbol ${}_{38}^{88}\text{Sr}$.
 What does the nucleus contain?
- A 38 electrons and 50 neutrons
 B 38 neutrons and 38 protons
 C 38 neutrons and 50 protons
 D 38 protons and 50 neutrons

BLANK PAGE

Permission to reproduce items where third-party owned material protected by copyright is included has been sought and cleared where possible. Every reasonable effort has been made by the publisher (UCLES) to trace copyright holders, but if any items requiring clearance have unwittingly been included, the publisher will be pleased to make amends at the earliest possible opportunity.

University of Cambridge International Examinations is part of the Cambridge Assessment Group. Cambridge Assessment is the brand name of University of Cambridge Local Examinations Syndicate (UCLES), which is itself a department of the University of Cambridge.