



UNIVERSITY OF CAMBRIDGE INTERNATIONAL EXAMINATIONS  
General Certificate of Education Ordinary Level

---

**PHYSICS**

Paper 1 Multiple Choice

**5054/01**

**May/June 2009**

**1 hour**

Additional Materials:      Multiple Choice Answer Sheet  
   Soft clean eraser  
   Soft pencil (type B or HB is recommended)



---

**READ THESE INSTRUCTIONS FIRST**

Write in soft pencil.

Do not use staples, paper clips, highlighters, glue or correction fluid.

Write your name, Centre number and candidate number on the Answer Sheet in the spaces provided unless this has been done for you.

There are **forty** questions on this paper. Answer **all** questions. For each question there are four possible answers **A, B, C** and **D**.

Choose the **one** you consider correct and record your choice in **soft pencil** on the separate Answer Sheet.

**Read the instructions on the Answer Sheet very carefully.**

Each correct answer will score one mark. A mark will not be deducted for a wrong answer.

Any rough working should be done in this booklet.

---

This document consists of **19** printed pages and **1** blank page.



- 1 Which instrument is most easily used to measure the internal diameter of a pipe?
- A manometer
  - B measuring cylinder
  - C micrometer
  - D vernier calipers
- 2 Which statement about scalars and vectors is correct?
- A A scalar has direction but no size.
  - B A scalar has size but no direction.
  - C A vector has direction but no size.
  - D A vector has size but no direction.
- 3 A free-fall parachutist falls at a constant speed. He then opens his parachute and continues to fall to Earth at a lower, constant speed.

Which diagram shows how the distance fallen by the parachutist varies with time?

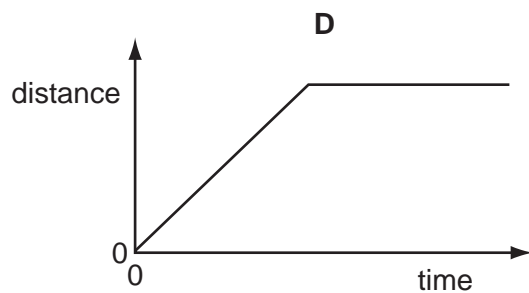
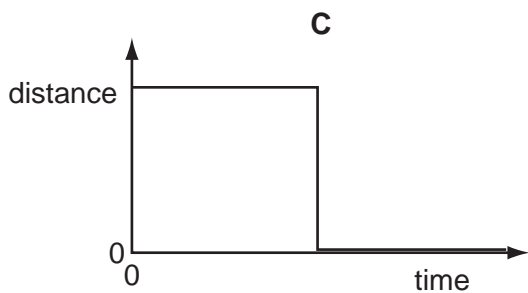
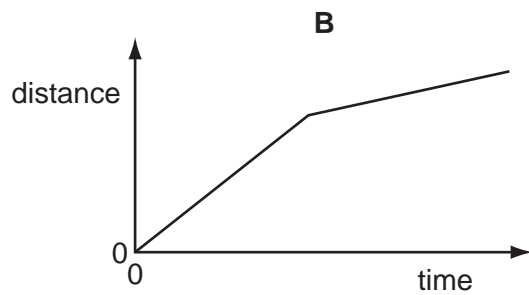
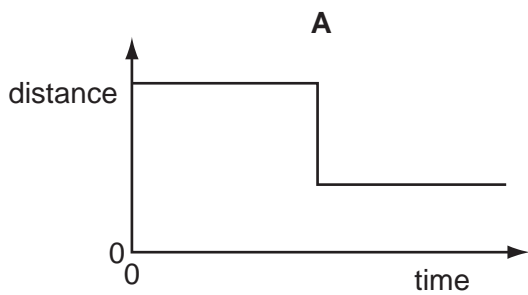

- 4 The graph shows the speed of a runner during a race.

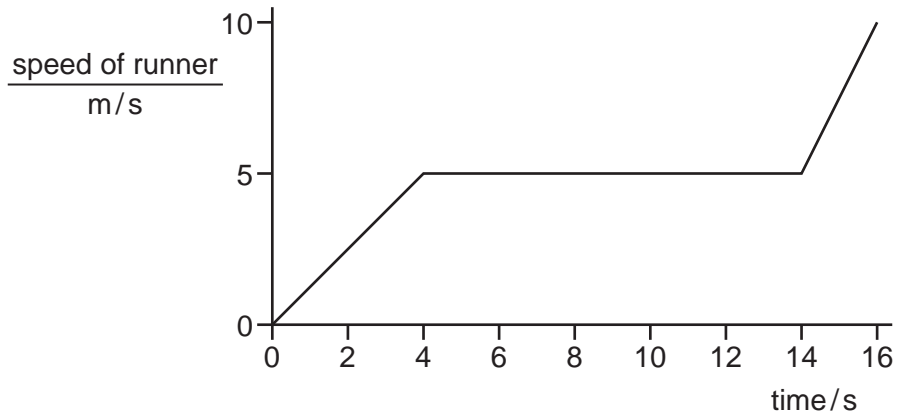

What is the distance travelled by the runner during the race?

- A** 50 m            **B** 65 m            **C** 75 m            **D** 90 m
- 5 A person just supports a mass of 20 kg suspended from a rope.

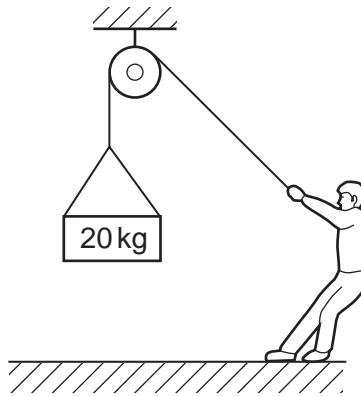

What is the resultant force acting on the mass?

- A** 0 N            **B** 10 N            **C** 20 N            **D** 200 N

- 6 A particle P is moving in a horizontal circle about O. P moves at constant speed  $v$ .

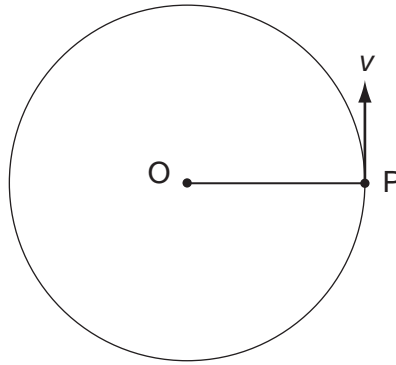

Which statement is true?

- A A force of constant magnitude is acting in the same direction as  $v$ .
  - B A force of constant magnitude is acting towards O.
  - C The force on P varies in size as it moves around the circle.
  - D There is no resultant force acting on P.
- 7 A measuring cylinder contains  $118 \text{ cm}^3$  of water. When a small object is fully immersed in the water, the reading goes up to  $132 \text{ cm}^3$ . The object has a mass of 42 g.

What is the density of the object?

- A  $\frac{14}{42} \text{ g/cm}^3$       B  $\frac{42}{14} \text{ g/cm}^3$       C  $\frac{42}{118} \text{ g/cm}^3$       D  $\frac{132}{42} \text{ g/cm}^3$

- 8 Two blocks are placed on a beam which balances on a pivot at its centre. The weight of the beam is negligible.

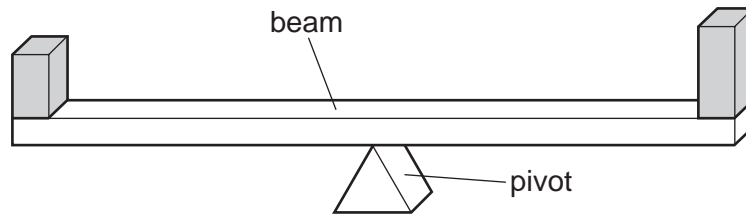

Which diagram shows the forces acting on the beam?  
(The length of each arrow represents the size of a force.)

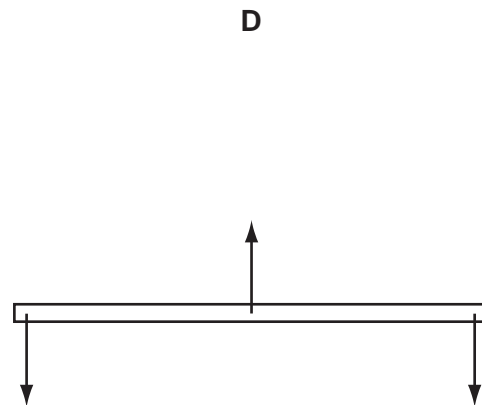
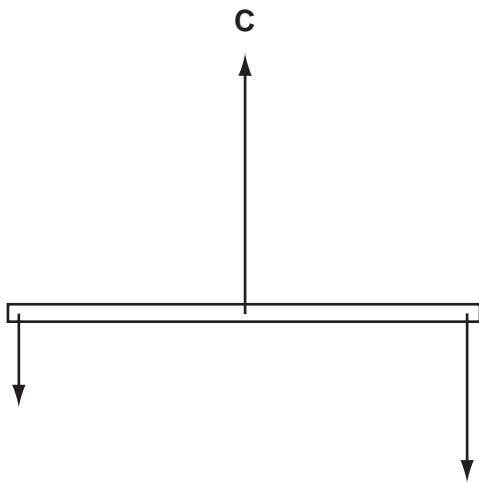
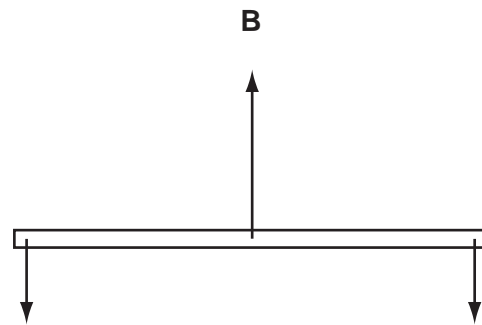
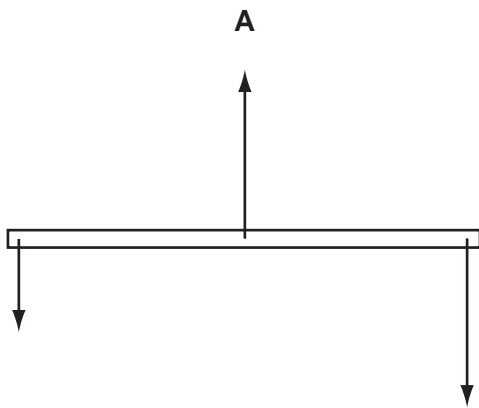

- 9 The graph shows the extension of a piece of copper wire as the load on it is increased.

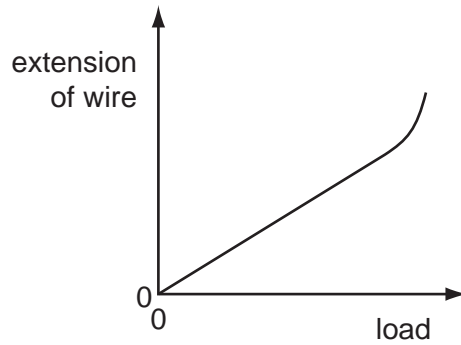

What does the graph show?

- A** At a certain load the wire becomes easier to extend.  
**B** At a certain load the wire becomes harder to extend.  
**C** The load and extension are directly proportional for any load.  
**D** The load and extension are inversely proportional for any load.
- 10 A builder leaves two identical, heavy, stone tiles resting on soft earth. One is vertical and the other is horizontal.

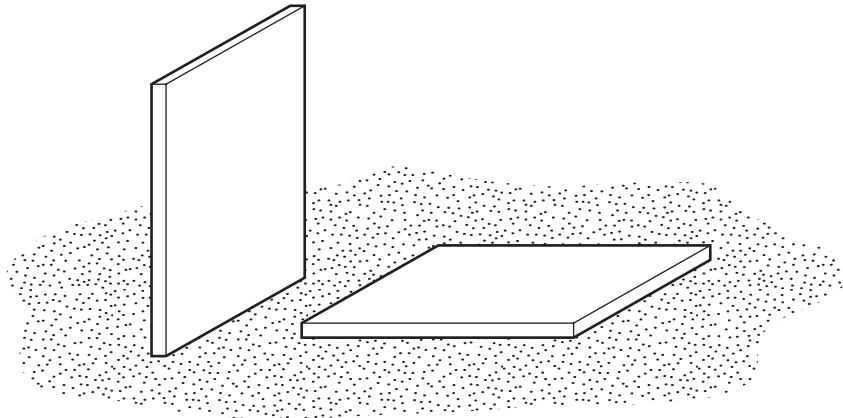

After a few hours, the vertical tile has started to sink into the soft earth, but the horizontal one has not.

Which row correctly compares the forces and the pressures that the tiles exert on the earth?

	forces	pressures
<b>A</b>	different	different
<b>B</b>	different	same
<b>C</b>	same	different
<b>D</b>	same	same

- 11 A water manometer is connected to a gas supply. One end of the manometer is open to the atmosphere.

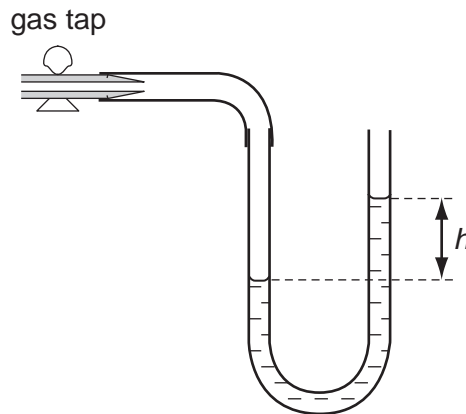

Which statement about the pressure of the gas supply is true?

- A The pressure is  $h$  cm of water.
  - B The pressure is  $h$  cm of water below atmospheric pressure.
  - C The pressure is the same as atmospheric pressure.
  - D The pressure is  $h$  cm of water above atmospheric pressure.
- 12 Which process in the Sun produces energy?
- A burning
  - B nuclear fission
  - C nuclear fusion
  - D radiation
- 13 A crane lifts a load of 1000 N through a vertical height of 3.0 m in 10 s. The input power to the crane is 500 J/s.

What is the efficiency of the crane?

- A 0.17
- B 0.50
- C 0.60
- D 0.67

- 14 The diagrams show four identical cans with their outside surfaces painted either dull black or polished silver. Each can contains the same volume of water, initially at 80°C.

After five minutes in a cool room, which can contains the **coolest** water?

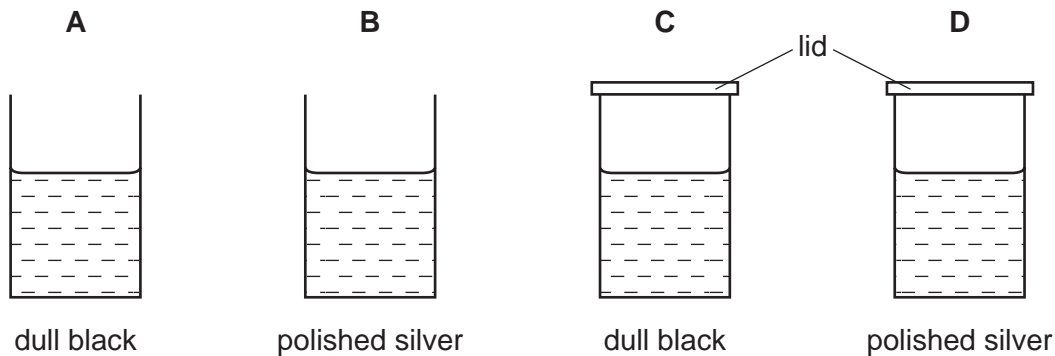

- 15 What makes a liquid-in-glass thermometer sensitive to a small change of temperature?

- A a bulb with a thin glass wall
- B a shiny liquid in its bore
- C a stem with a thick glass wall
- D a very narrow bore

- 16 A substance that is originally a solid is heated strongly for some time.

At one stage, the energy given to the substance is used as latent heat of vaporisation.

At this stage, what change does the energy cause?

- A It breaks the bonds holding the molecules together. Molecules escape from the liquid.
- B It breaks the bonds holding the molecules together. The solid becomes liquid.
- C It makes the molecules move faster but there is still a strong attraction between them.
- D It makes the molecules move faster and so the temperature rises.

- 17 What happens when a metal bar is heated?

- A The distance between the molecules increases, making the bar longer.
- B The molecules get larger, making the bar longer.
- C The molecules vibrate more quickly, making the bar denser.
- D The speed of the molecules increases, making the bar thinner.



18 A fixed mass of gas at constant temperature is compressed to reduce its volume.

How do the molecules of gas now strike the walls of the container?

- A less often than before with a higher velocity
- B less often than before with the same velocity
- C more often than before with a higher velocity
- D more often than before with the same velocity

19 Which diagram correctly represents water waves travelling from deep water to shallow water?

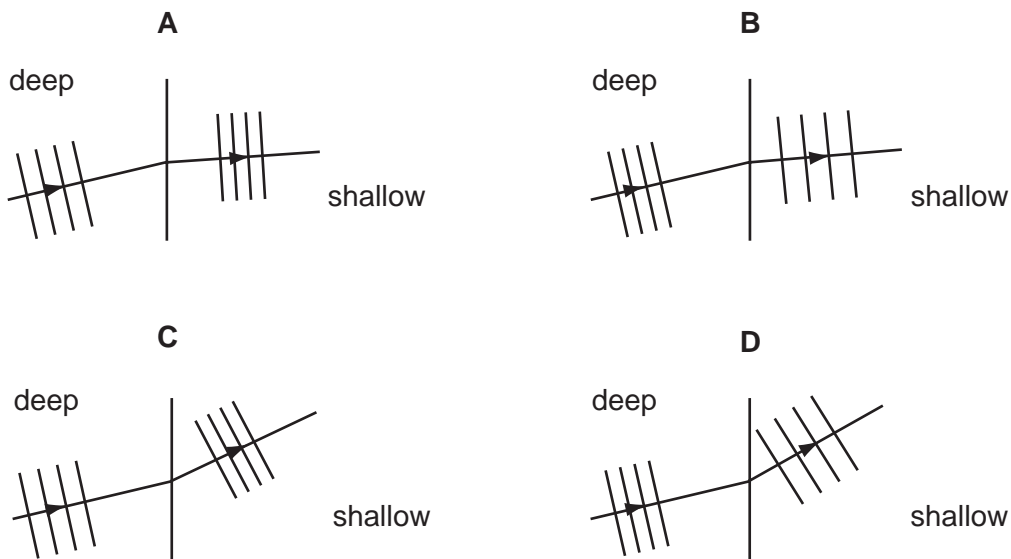

20 Which characteristics describe an image formed by a plane mirror?

- A real and inverted
- B virtual and upright
- C real and larger than the object
- D virtual and smaller than the object

- 21 The diagram shows four rays of light from a lamp below the surface of some water. What is the critical angle for light in water?

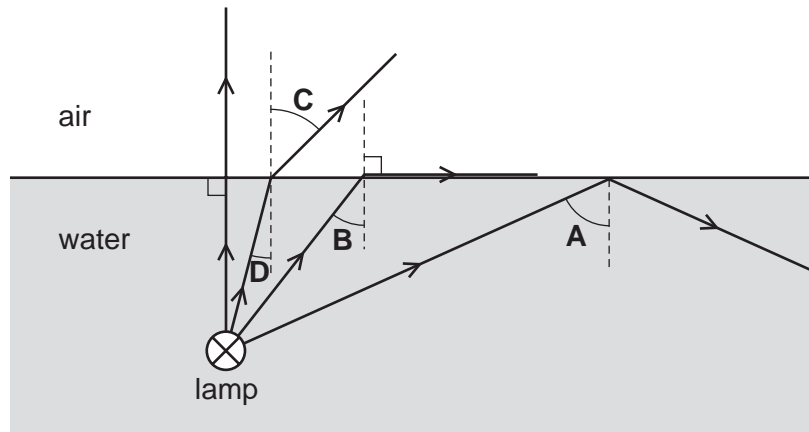

- 22 When white light is dispersed by a prism, compared with blue light, the **red** light is
- A slowed down less and refracted less.
  - B slowed down less and refracted more.
  - C slowed down more and refracted less.
  - D slowed down more and refracted more.
- 23 An ultrasonic tape-measure is used to find the distance to a wall. It sends out an ultrasonic pulse and times how long it takes for the reflected pulse to return from the wall.

The ultrasound has a frequency, a wavelength and a speed.

Which pair of values is needed to find the distance to the wall?

- A frequency and wavelength
- B frequency and time taken for the pulse to return
- C speed and time taken for the pulse to return
- D wavelength and time taken for the pulse to return

24 An iron nail can be magnetised using a coil.

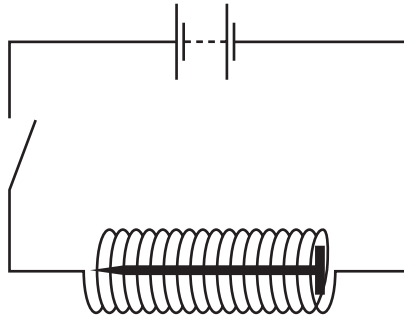

How can the nail be demagnetised?

- A leaving the apparatus switched on for a long time
  - B removing the nail from the coil while using an a.c. supply
  - C using a coil with fewer turns
  - D using more cells
- 25 A negatively-charged balloon is brought towards a wall.

Which statement explains what happens?

- A Negative charges on the balloon attract the negative charges in the wall.
- B Negative charges on the balloon have no effect on the charges in the wall.
- C Negative charges on the balloon repel the negative charges in the wall.
- D Negative charges on the balloon repel the positive charges in the wall.

- 26 When a filament lamp is switched on, there is a current in the lamp. As the temperature of the filament rises, its resistance changes.

Which pair of graphs shows how the resistance  $R$  of the filament and the current  $I$  vary with time after the lamp is switched on?

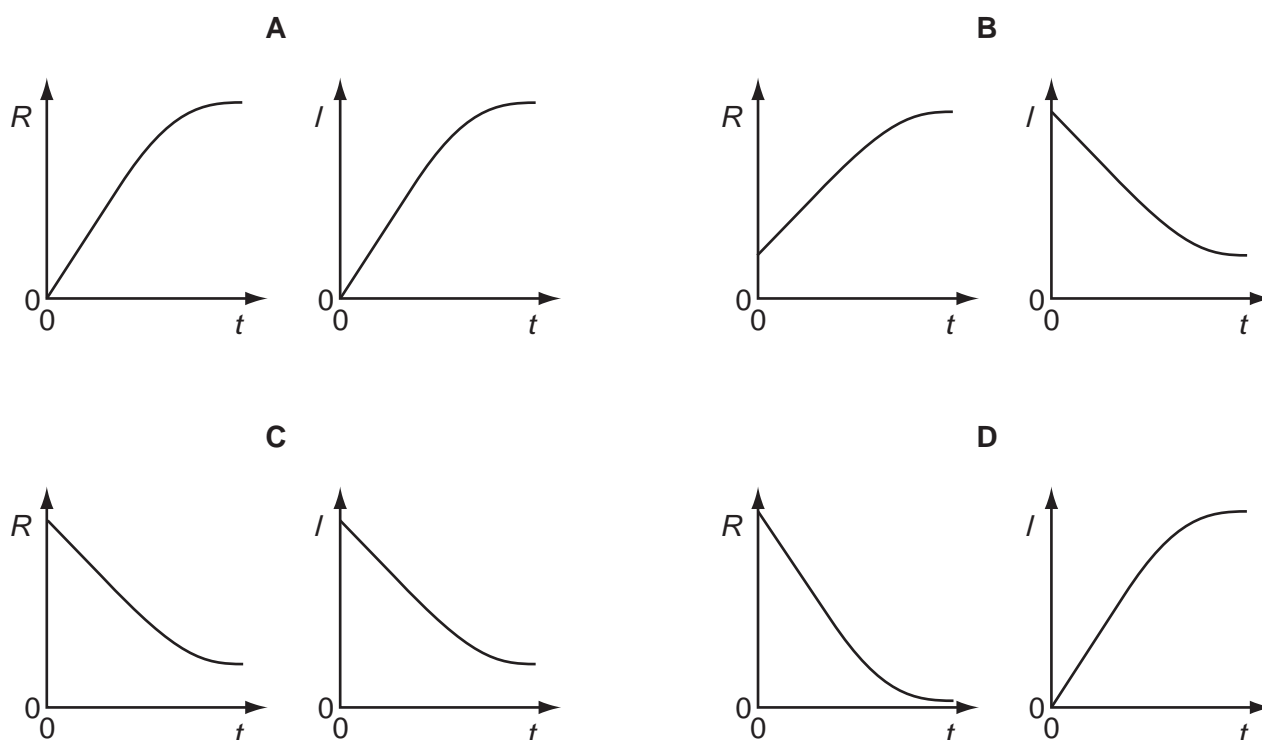

- 27 One volt can also be written as

- A one coulomb per ampere.
- B one coulomb per joule.
- C one joule per ampere.
- D one joule per coulomb.

- 28 A student has a chain of 20 lamps. These are wired in series and connected to the mains.

One lamp blows and all the others go out.

The student wants to find the faulty lamp and replace it.

Where should the student begin?

- A anywhere, because the current was the same in each lamp
- B at the live end of the chain, because the current was greatest there
- C at the middle of the chain, because the current was greatest there
- D at the neutral end of the chain, because the current was least there

29 An electric iron is marked 240 V, 2500 W.

Four fuses are available with values of 5 A, 10 A, 13 A and 30 A.

Which fuse should be used?

- A** 5 A                      **B** 10 A                      **C** 13 A                      **D** 30 A

30 A plug is wrongly wired as shown. It is connected to an old vacuum cleaner, which has a metal case.

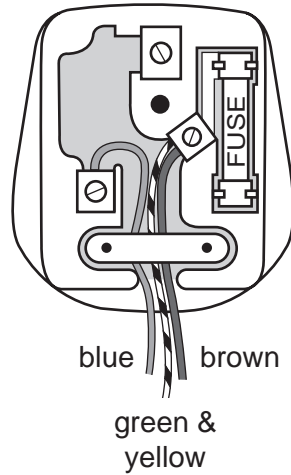

What is the effect of using the plug wired in this way?

- A** The fuse in the plug blows.  
**B** The metal case is live.  
**C** The neutral wire melts.  
**D** The vacuum cleaner catches fire.

31 An a.c. supply is connected to a wire stretched between the poles of a magnet.

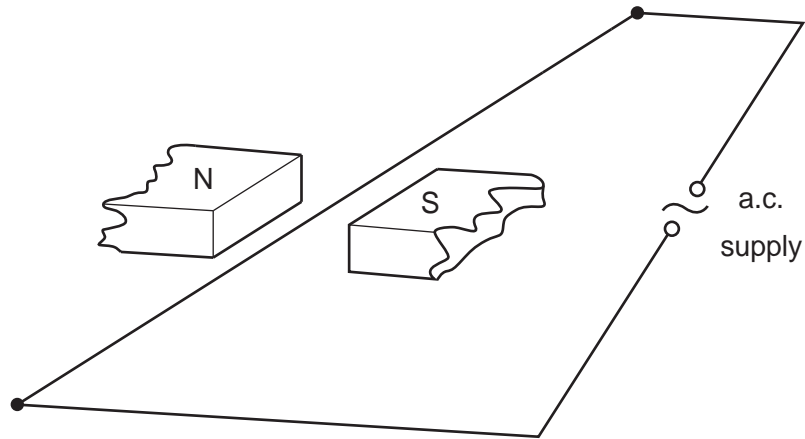

Which way will the wire move?

- A left and right
- B right only
- C up and down
- D up only

32 A d.c. motor consists of a coil of many turns rotating in a fixed magnetic field. The coil is connected to a d.c. supply through a split-ring commutator.

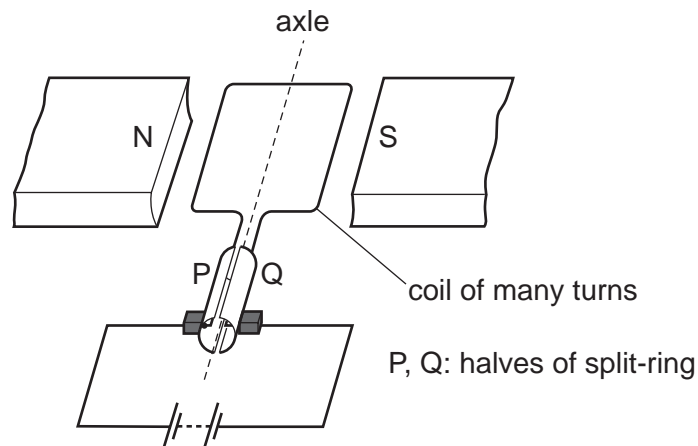

Some changes are made, one at a time.

- The d.c. supply is reversed.
- The coil is turned before switching on, so that P starts on the right and Q on the left.
- The poles of the magnet are reversed.
- The turns on the coil are increased in number.

How many of these changes make the coil rotate in the opposite direction?

- A 1
- B 2
- C 3
- D 4

33 The diagram shows an a.c. generator connected to a resistor.

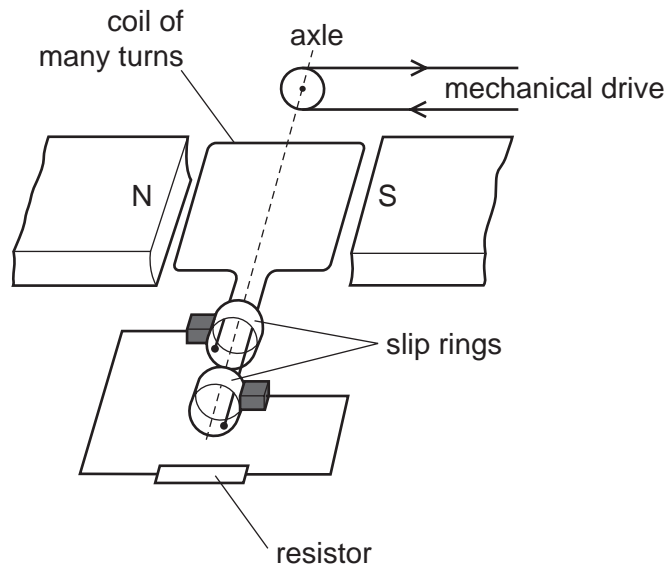

Some changes are made, one at a time.

- The speed of the drive is changed.
- The strength of the magnets is changed.
- The number of turns in the coil is changed.
- The value of the resistor is changed.

How many of these alter the value of the e.m.f. generated in the coil?

- A** 1                      **B** 2                      **C** 3                      **D** 4

34 A simple a.c. generator produces a voltage that varies with time as shown.

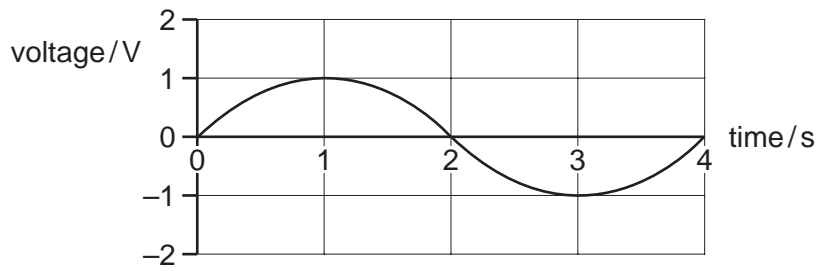

Which graph shows how the voltage varies with time when the generator rotates at twice the original speed?

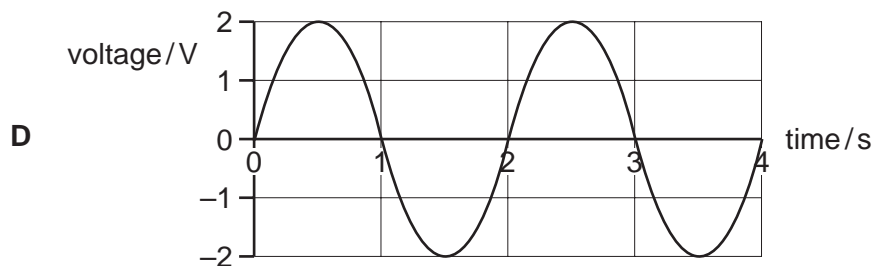
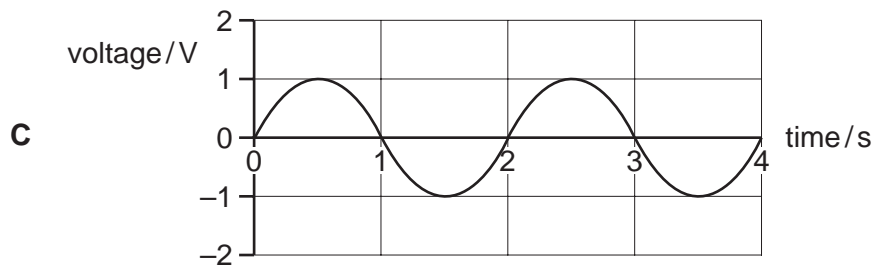
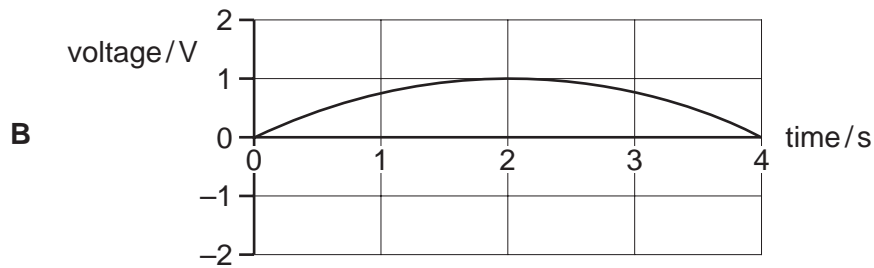
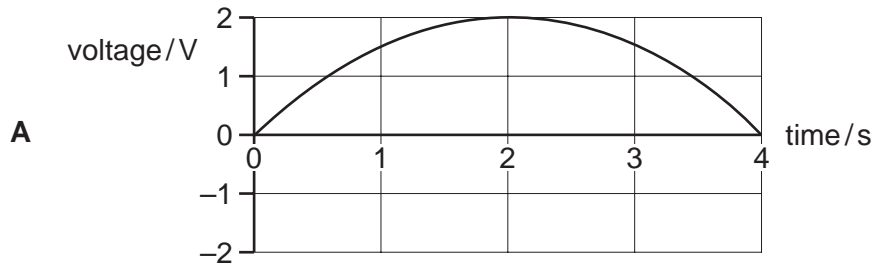



- 35 Why is electrical energy usually transmitted at high voltage?
- A As little energy as possible is wasted in the transmission cables.
  - B The current in the transmission cables is as large as possible.
  - C The resistance of the transmission cables is as small as possible.
  - D The transmission system does not require transformers.
- 36 A lamp is connected in series with a light-dependent resistor (LDR) and a battery. The barrier shields the LDR from the lamp.

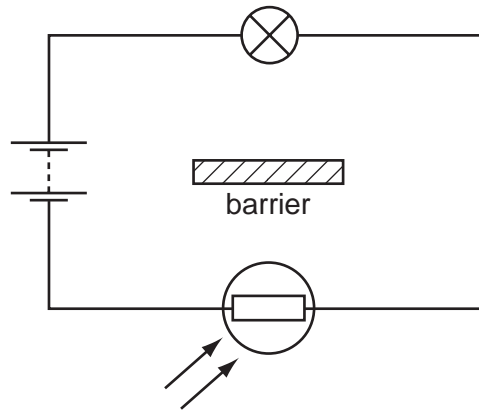

When low intensity light falls on the LDR, the lamp glows dimly.

If the light intensity on the LDR increases, what happens to the lamp?

- A It gets brighter.
- B It gets dimmer but does not go out.
- C It goes out.
- D It stays the same.

- 37 The circuit diagram shows a variable resistor  $R$  connected in parallel to the lower half of a potential divider.

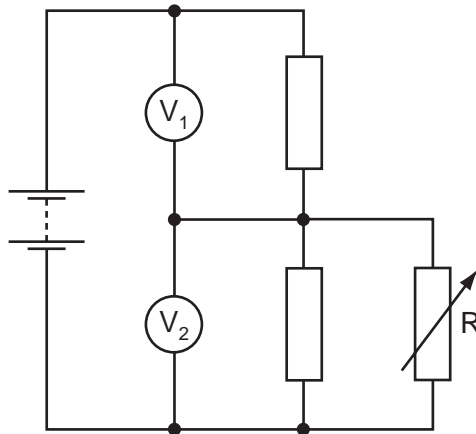

The resistance of  $R$  increases.

What happens to the two voltmeter readings?

	reading on $V_1$	reading on $V_2$
<b>A</b>	decreases	decreases
<b>B</b>	decreases	increases
<b>C</b>	increases	decreases
<b>D</b>	increases	increases

- 38 A radioactive source emits alpha-particles, beta-particles and gamma-rays. A Geiger-Müller tube and counter detect the emissions, which pass through a thin sheet of paper and a strong magnetic field.

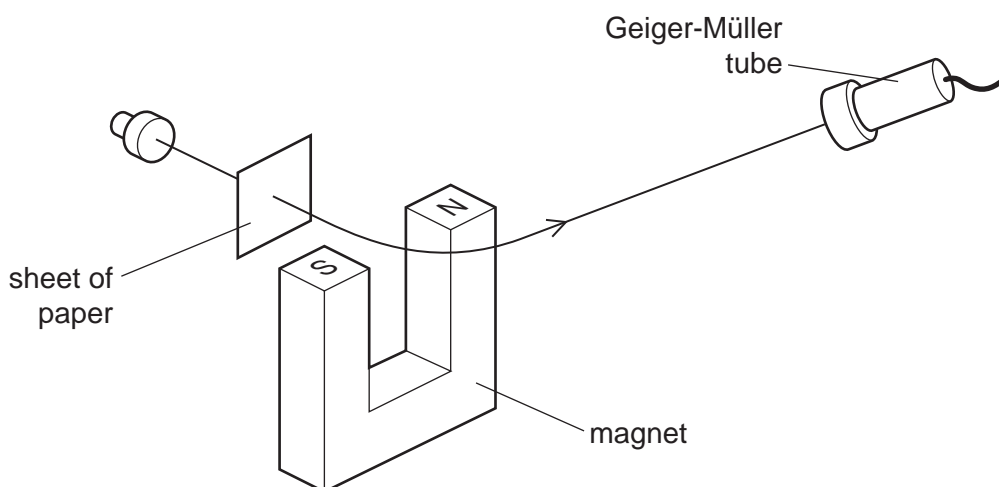

What is detected by the Geiger-Müller tube?

- A alpha-particles and beta-particles
  - B alpha-particles only
  - C beta-particles and gamma-rays
  - D beta-particles only
- 39 The count-rate from a radioactive source falls from 400 to 50 in 3.0 minutes.

What is the half-life?

- A 0.75 minutes
  - B 1.0 minutes
  - C 2.7 minutes
  - D 8.0 minutes
- 40 What are the numbers of neutrons, protons and electrons in a neutral atom of  ${}_{92}^{235}\text{U}$ ?

	number of neutrons	number of protons	number of electrons
A	92	143	143
B	92	235	235
C	143	92	92
D	235	92	92

**BLANK PAGE**

---

Permission to reproduce items where third-party owned material protected by copyright is included has been sought and cleared where possible. Every reasonable effort has been made by the publisher (UCLES) to trace copyright holders, but if any items requiring clearance have unwittingly been included, the publisher will be pleased to make amends at the earliest possible opportunity.

University of Cambridge International Examinations is part of the Cambridge Assessment Group. Cambridge Assessment is the brand name of University of Cambridge Local Examinations Syndicate (UCLES), which is itself a department of the University of Cambridge.