



UNIVERSITY OF CAMBRIDGE INTERNATIONAL EXAMINATIONS
General Certificate of Education Ordinary Level

PHYSICS

5054/01

Paper 1 Multiple Choice

May/June 2008

1 hour

Additional Materials: Multiple Choice Answer Sheet
Soft clean eraser
Soft pencil (type B or HB is recommended)



READ THESE INSTRUCTIONS FIRST

Write in soft pencil.

Do not use staples, paper clips, highlighters, glue or correction fluid.

Write your name, Centre number and candidate number on the Answer Sheet in the spaces provided unless this has been done for you.

There are **forty** questions on this paper. Answer **all** questions. For each question there are four possible answers **A, B, C** and **D**.

Choose the **one** you consider correct and record your choice in **soft pencil** on the separate Answer Sheet.

Read the instructions on the Answer Sheet very carefully.

Each correct answer will score one mark. A mark will not be deducted for a wrong answer.

Any rough working should be done in this booklet.

This document consists of **17** printed pages and **3** blank pages.



1 What is the reading on this micrometer?

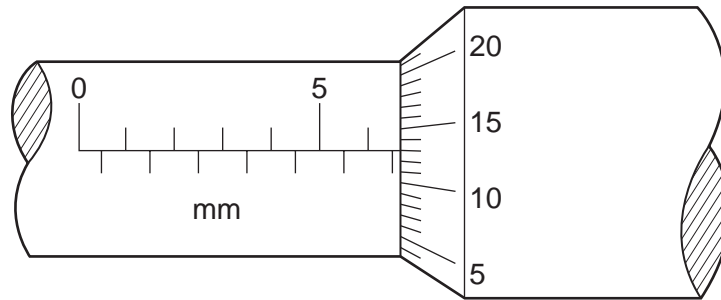

- A** 5.43 mm **B** 6.63 mm **C** 7.30 mm **D** 8.13 mm

2 Two forces F_1 and F_2 act on an object O in the directions shown.

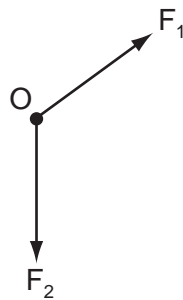

What is the direction of the resultant force?

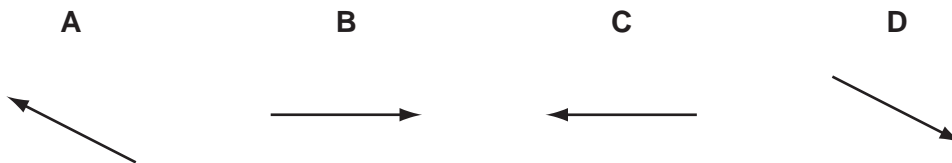

3 A wooden block is pushed across a table at constant speed.

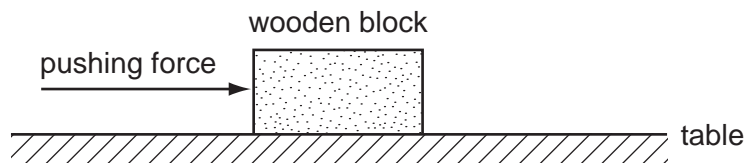

Which statement is correct?

- A** The frictional force increases as the block moves at constant speed.
B The frictional force is equal and opposite to the pushing force.
C The frictional force is greater than the pushing force.
D The frictional force is less than the pushing force.

- 4 A skier is travelling downhill. The acceleration on hard snow is 4 m/s^2 and on soft snow is 2 m/s^2 .

Which graph shows the motion of the skier when moving from hard snow to soft snow?

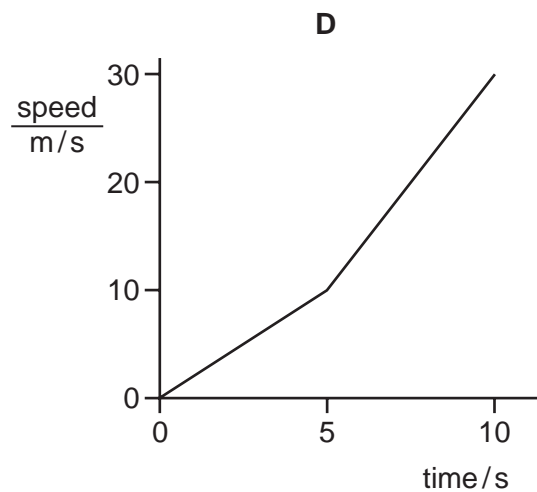
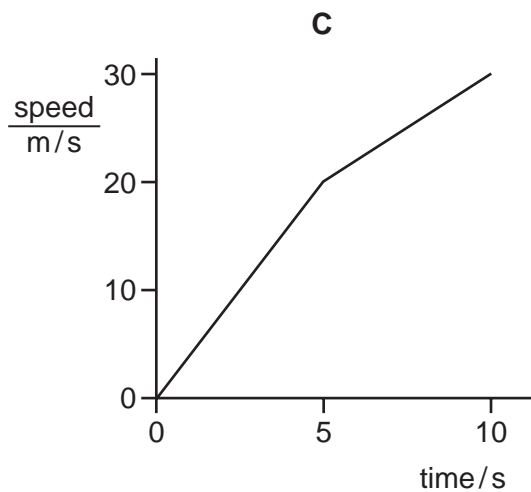
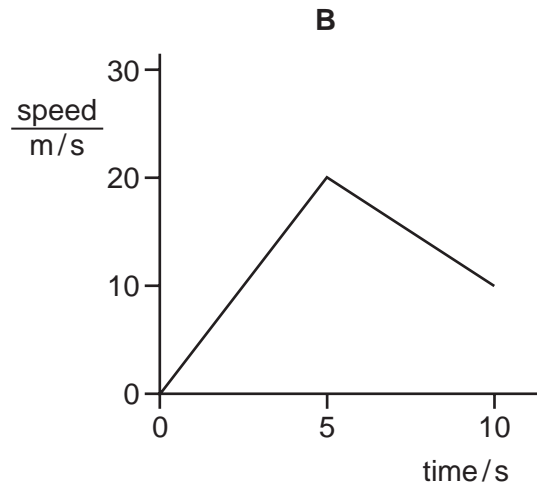
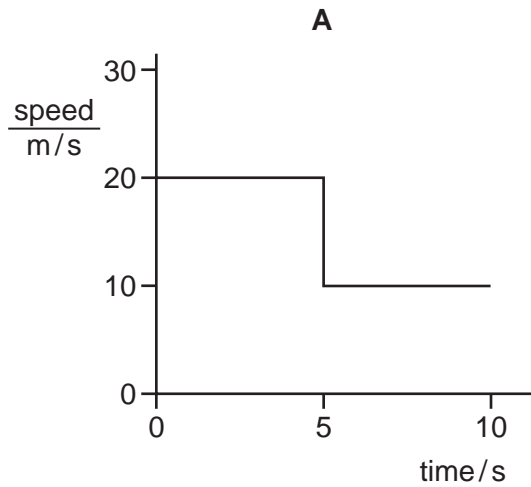

- 5 What keeps an electron moving in a circle around the nucleus of an atom?
- A a gravitational force away from the nucleus
 - B a gravitational force towards the nucleus
 - C an electrostatic force away from the nucleus
 - D an electrostatic force towards the nucleus

- 6 A lump of metal has a mass of 210 g. It is lowered into a measuring cylinder containing water. The level of the water rises from 35 cm^3 to 140 cm^3 .

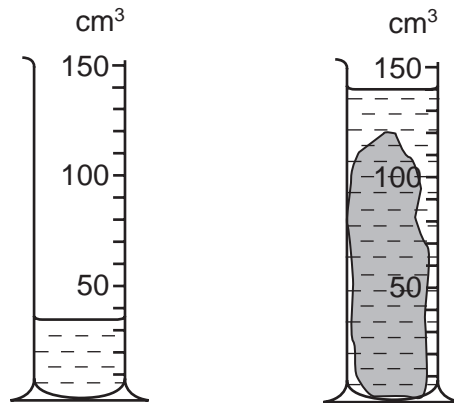

What is the density of the metal?

- A** 0.67 g/cm^3 **B** 1.5 g/cm^3 **C** 2.0 g/cm^3 **D** 6.0 g/cm^3
- 7 An extension-load graph for a wire is shown.

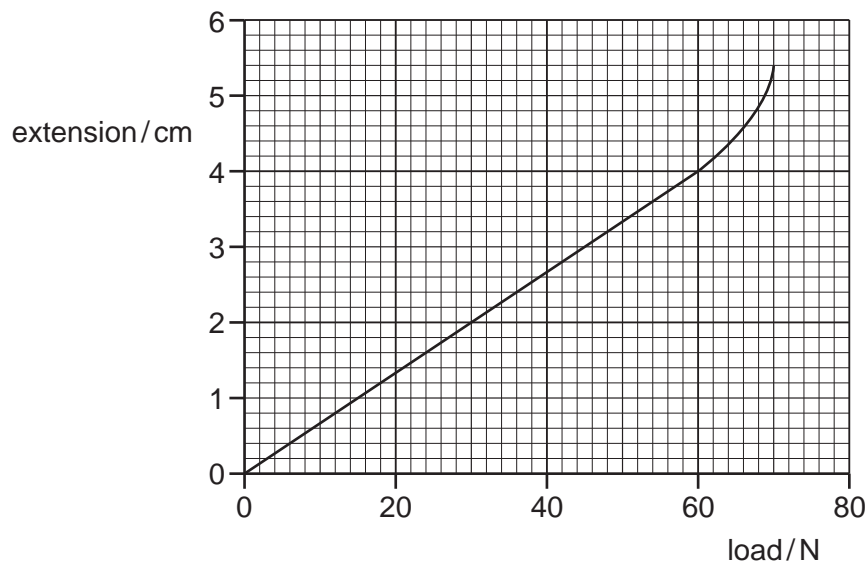

What is the load at the limit of proportionality for the wire?

- A** 4 N **B** 15 N **C** 60 N **D** 70 N

- 8 A flat lamina is freely suspended from point P.

The weight of the lamina is 2.0 N and the centre of mass is at C.

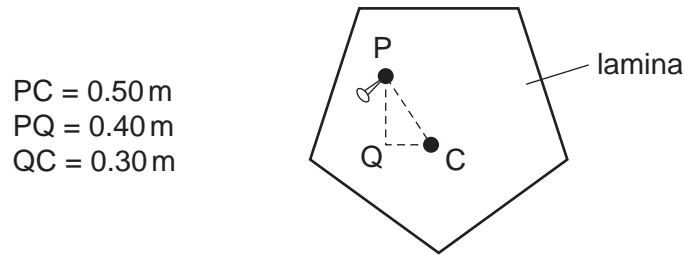

The lamina is displaced to the position shown.

What is the moment that will cause the lamina to swing?

- A 0.60 N m clockwise
B 0.80 N m anticlockwise
C 1.0 N m clockwise
D 1.0 N m anticlockwise
- 9 A ball is held at rest on one side of a curved track.

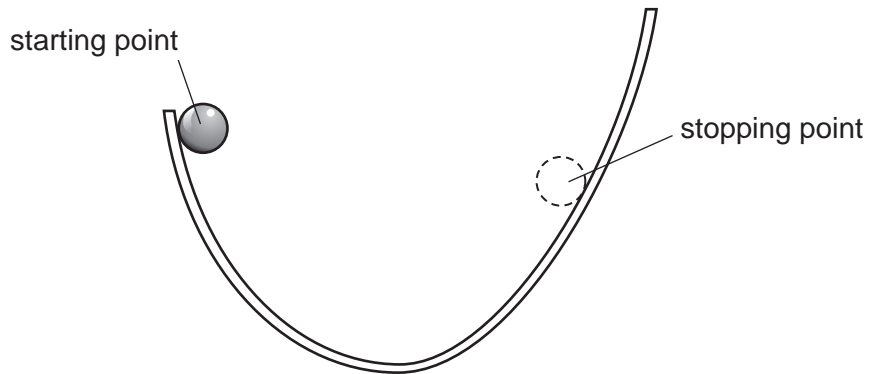

The ball is released. It rolls down one side of the track and part of the way up the other side. It then stops, before rolling back down again. The height of the stopping point is less than that of the starting point.

What is the sequence of energy changes between starting and stopping for the first time?

- A potential energy → kinetic energy → potential energy + heat
B potential energy → kinetic energy → heat → potential energy
C potential energy → heat → kinetic energy → potential energy
D potential energy → kinetic energy + heat → potential energy + heat

- 10 A workman rolls a barrel of weight 2000 N up a plank of length 2.00 m and on to a lorry. The back of the lorry is 0.80 m above the horizontal surface of the road.

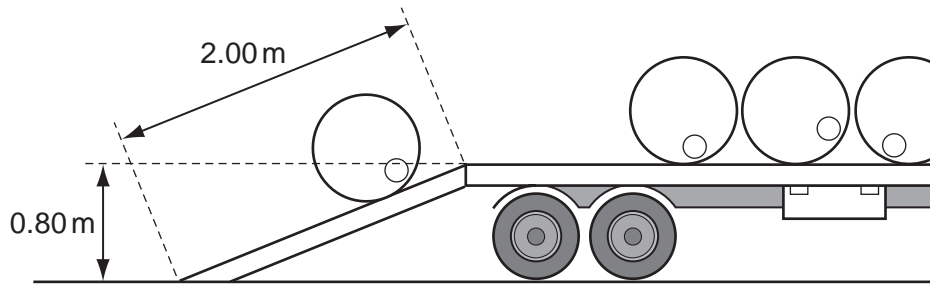

What is the work done on the barrel against gravity?

- A 1000 J B 1600 J C 2500 J D 4000 J
- 11 Energy from petrol is used to operate an engine. The engine drives a generator, which produces electrical energy.

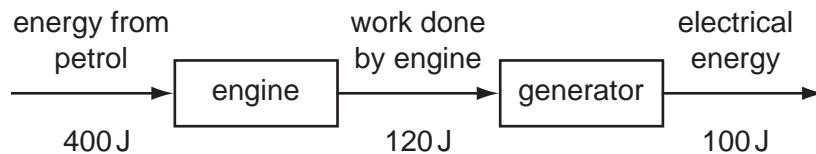

What is the overall efficiency of the process?

- A 25% B 30% C 55% D 83%
- 12 Which statement about the pressure in a column of liquid is correct?
- A It acts only vertically downwards.
- B It increases if the column width increases.
- C It increases with depth in the column.
- D It is uniform throughout the column.
- 13 An airtight container holds a fixed quantity of gas. Its pressure and volume are measured on four occasions when the temperature is 20 °C.

The results are shown in the table.

Which set of readings is **incorrect**?

	pressure / kPa	volume / cm ³
A	120	36
B	100	48
C	80	60
D	60	80

14 In a vacuum flask, which methods of heat transfer are prevented by the vacuum?

- A conduction only
- B convection only
- C conduction and convection only
- D conduction, convection, and radiation

15 The diagram shows a liquid-in-glass thermometer.

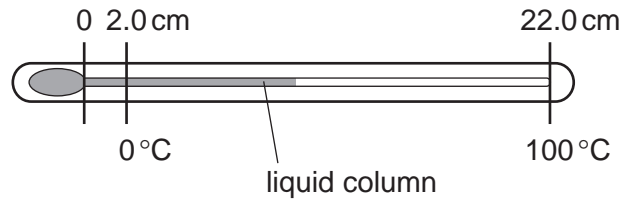

At 0 °C, the length of the liquid column is 2.0 cm. At 100 °C, the length of the liquid column is 22.0 cm.

What is the length of the liquid column at 40 °C?

- A 6.0 cm
- B 8.0 cm
- C 8.8 cm
- D 10.0 cm

16 At regular intervals along a railway line there is a gap between the rail sections.

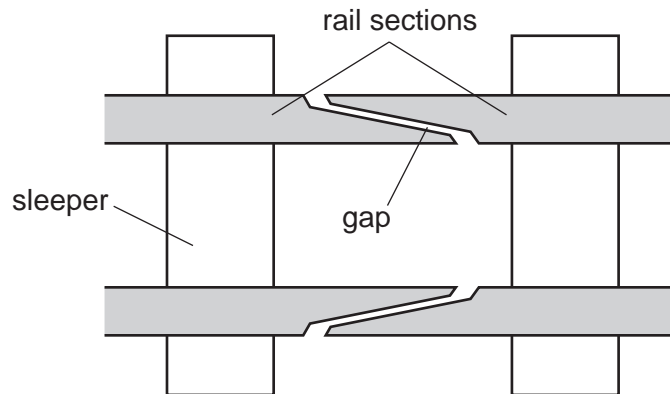

What is the reason for the gap between the rail sections?

- A to allow for expansion of the rail sections during hot weather
- B to allow for vibrations of the rail sections as the train passes over them
- C to allow rain water to drain from the rail sections
- D to keep the wheels of the train and carriages on the rail sections

- 17 Ice is taken from a freezer and left in a room. The ice melts and eventually the water reaches room temperature.

Which energy transfers take place?

	energy transfer during melting	energy transfer after melting
A	from ice to room	from water to room
B	from ice to room	from room to water
C	from room to ice	from room to water
D	from room to ice	from water to room

- 18 Some air is trapped inside a small balloon. The average kinetic energy of the air molecules in the balloon is increased.

What remains the same?

- A** the density of the air in the balloon
- B** the mass of the air in the balloon
- C** the temperature of the air in the balloon
- D** the volume of the air in the balloon

- 19 A student is investigating the evaporation of water.



The student can change:

- the depth of the water;
- the surface area of the water;
- the temperature of the water.

How many of these changes, if any, would alter the rate at which evaporation occurs?

- A** 0
- B** 1
- C** 2
- D** 3

20 The diagrams show different views of a water wave in a ripple tank.

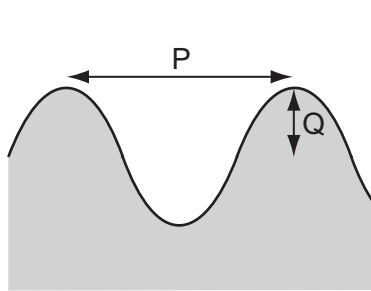

cross-section of wave

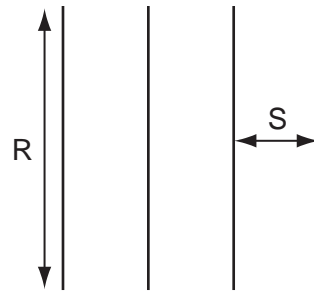

crests seen from above

Which letters represent a wavelength and a wavefront?

	wavelength	wavefront
A	P	R
B	P	S
C	Q	R
D	Q	S

21 A ripple tank is used to demonstrate refraction of plane water waves.

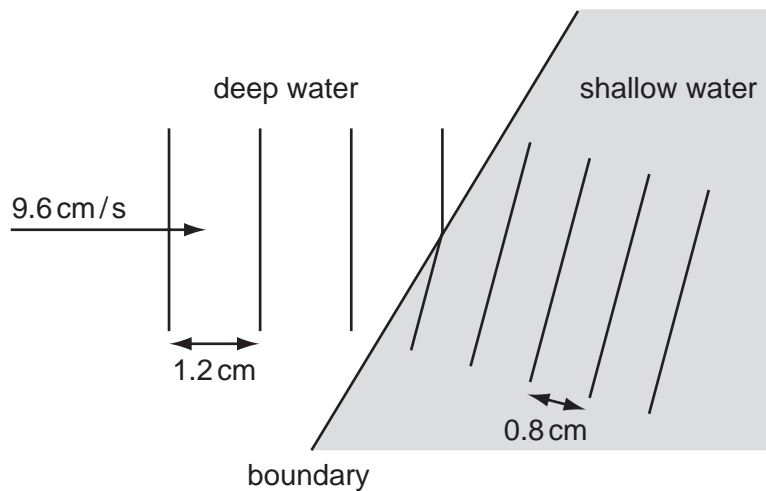

Waves in deep water have a wavelength of 1.2 cm and a speed of 9.6 cm/s. The wavelength of the waves in shallow water is 0.8 cm.

What is the speed of the waves in the shallow water?

- A** 6.4 cm/s **B** 8.0 cm/s **C** 9.6 cm/s **D** 14.4 cm/s

22 A ray of red light enters a semi-circular glass block normal to the curved surface.

Which diagram correctly shows the partial reflection and refraction of the ray?

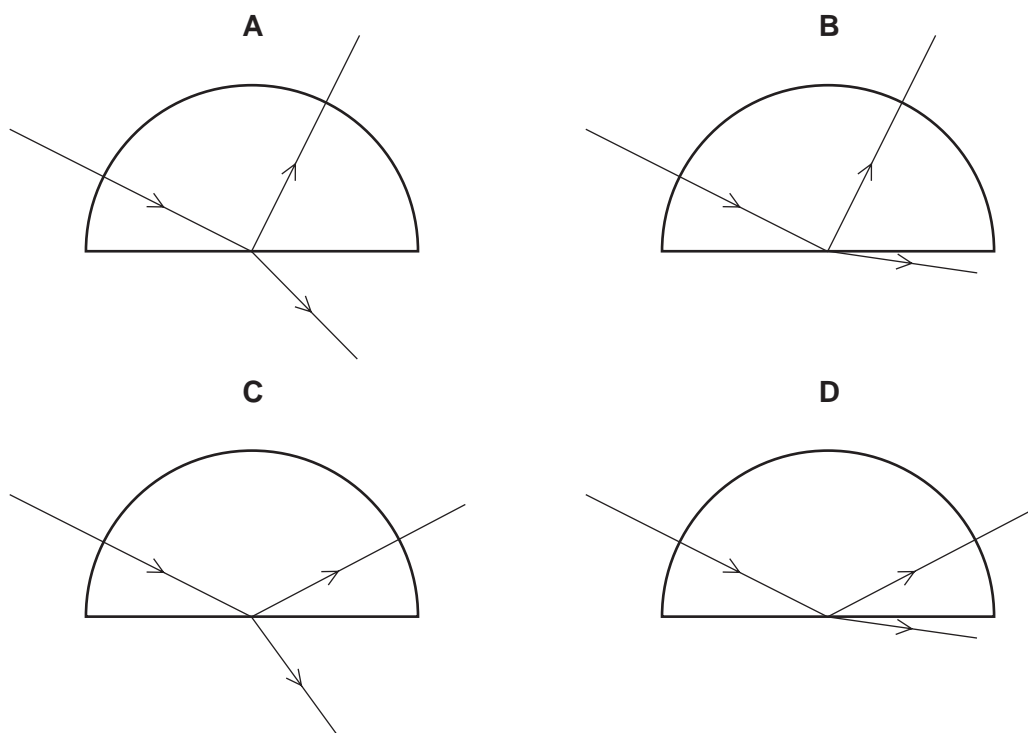

23 An object 5.0 cm high is placed 2.0 cm from a converging (convex) lens which is being used as a magnifying glass.

The image produced is 6.0 cm from the lens and is 15 cm high.

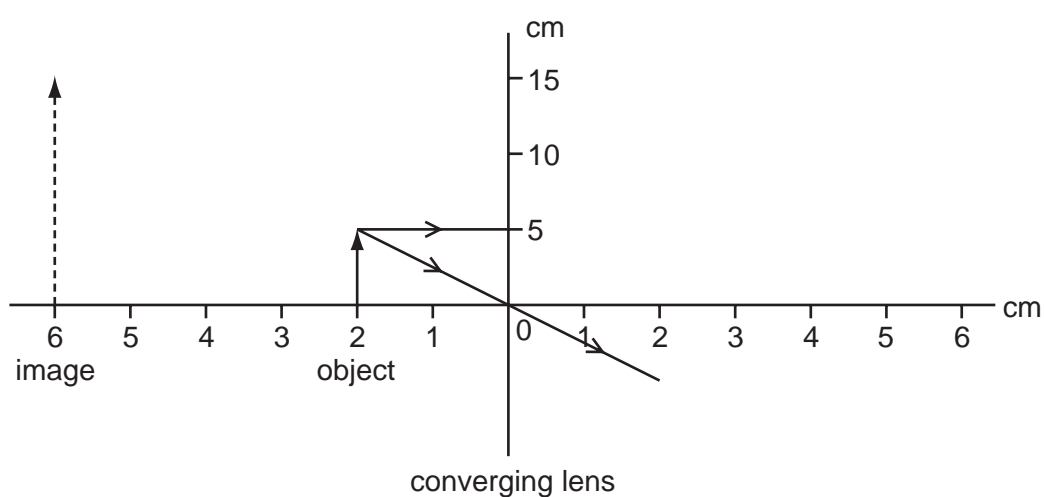

What is the focal length of the lens?

- A** 2.0 cm **B** 3.0 cm **C** 4.0 cm **D** 6.0 cm

24 A man is short-sighted.

Which ray diagram shows what happens when he looks at a distant object?

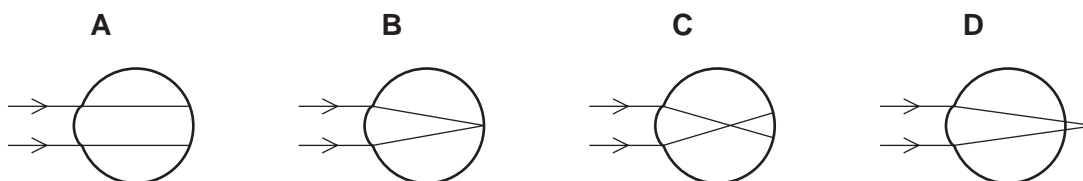

25 Which colour, red or blue, has the higher frequency and which has the longer wavelength?

	higher frequency	longer wavelength
A	blue	blue
B	blue	red
C	red	blue
D	red	red

26 Waveforms are shown on a cathode-ray oscilloscope for a flute and a guitar playing the same note. The oscilloscope settings are the same for both waveforms.

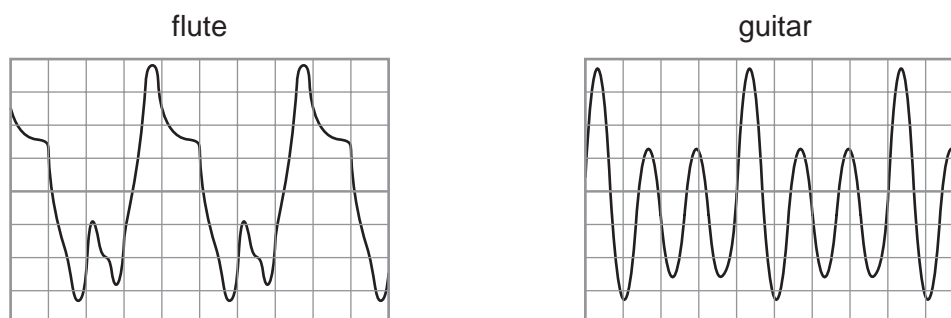

What is the difference between the two sounds?

- A** the amplitude
- B** the frequency
- C** the quality (timbre)
- D** the wavelength

27 The diagram shows how a steel bar can be magnetised.

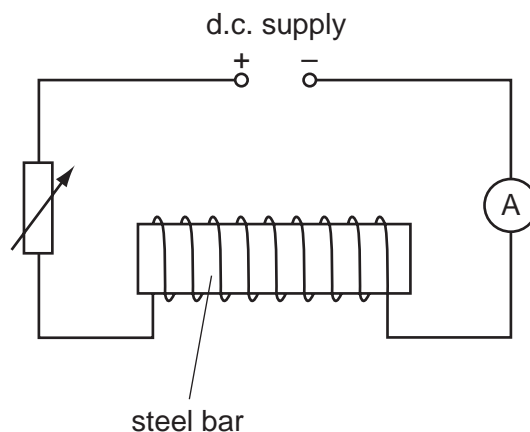

Which statement describes how the steel bar can be demagnetised?

- A Reverse the d.c. supply and gradually decrease the current in the circuit.
- B Reverse the d.c. supply and gradually increase the current in the circuit.
- C Use an a.c. supply and gradually decrease the current in the circuit.
- D Use an a.c. supply and gradually increase the current in the circuit.

28 A perspex rod can be charged positively by rubbing it with a woollen cloth.

How does the rod gain its charge?

- A The rod gains electrons.
- B The rod gains protons.
- C The rod loses electrons.
- D The rod loses protons.

29 Which diagram correctly shows the electric field lines between two point charges?

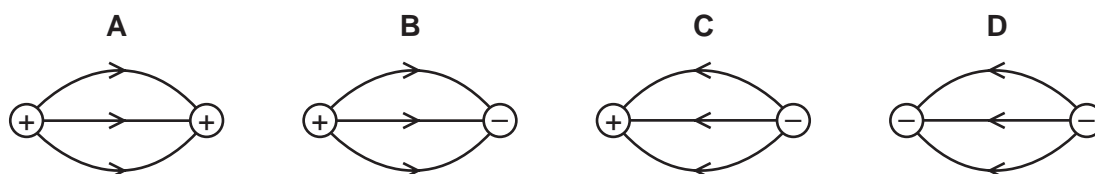

30 Three identical heating elements are wired up to the mains supply in the three arrangements shown.

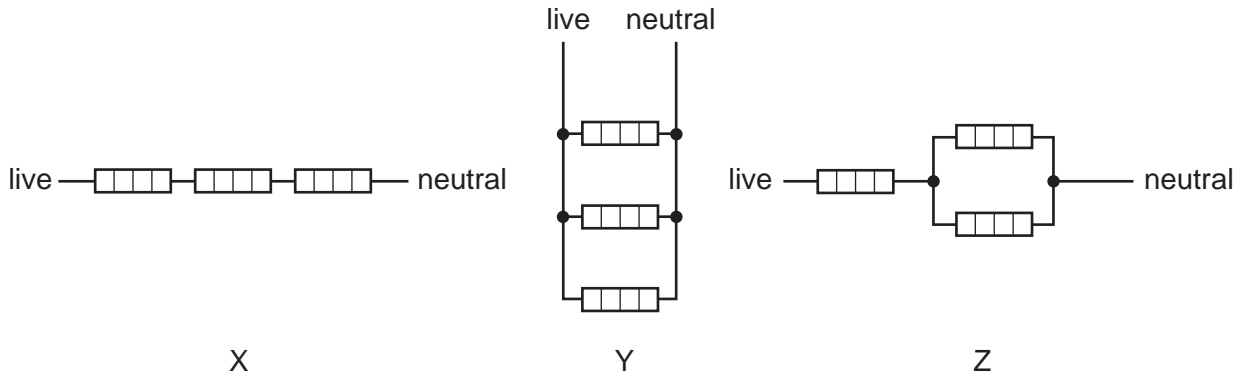

In which arrangement is the current from the supply lowest and in which is it highest?

	lowest current	highest current
A	X	Z
B	X	Y
C	Y	X
D	Y	Z

31 The diagram shows the components of a lighter for a gas cooker.

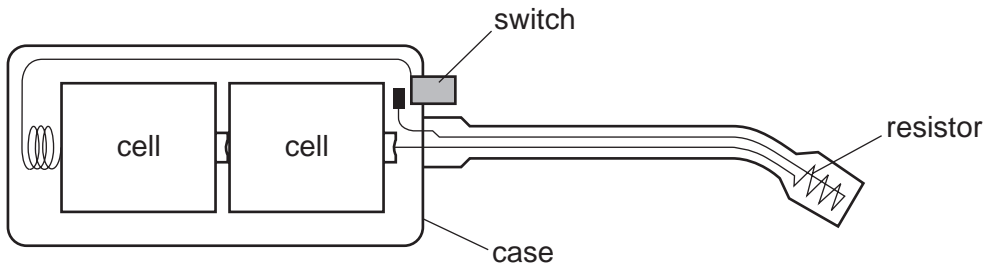

Which circuit diagram is correct for this lighter?

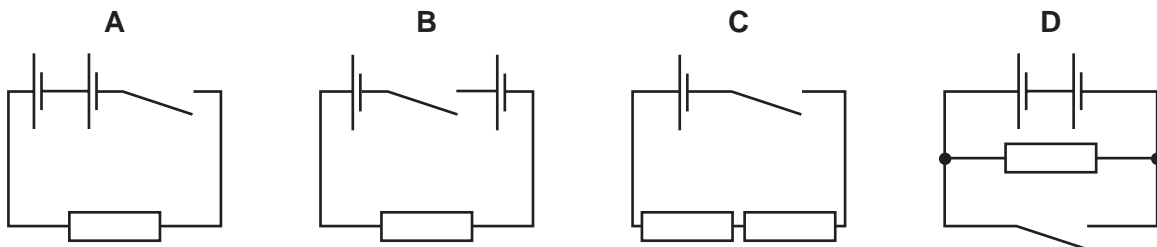

32 In each of the circuits below there is a short circuit.

In which circuit does the fuse blow and make the circuit safe to repair?

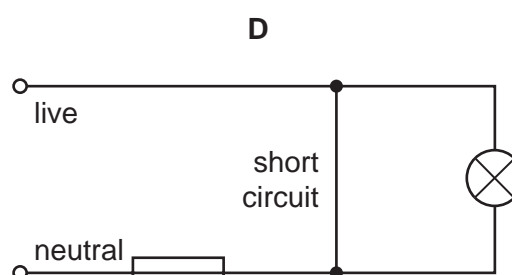
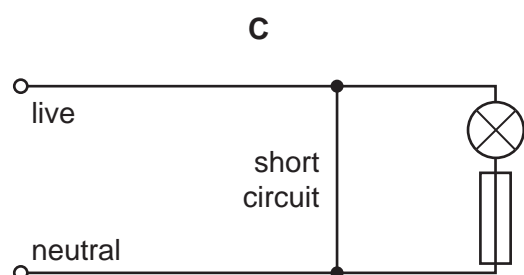
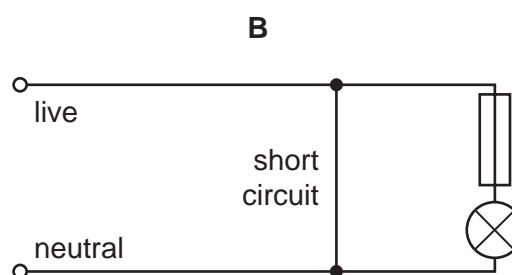
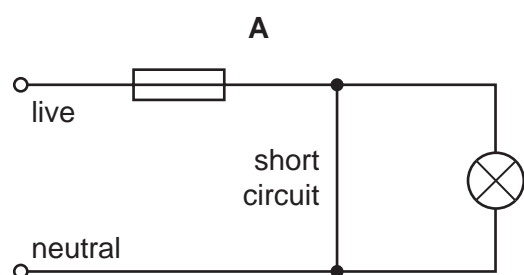

33 The diagram shows a simple electric motor.

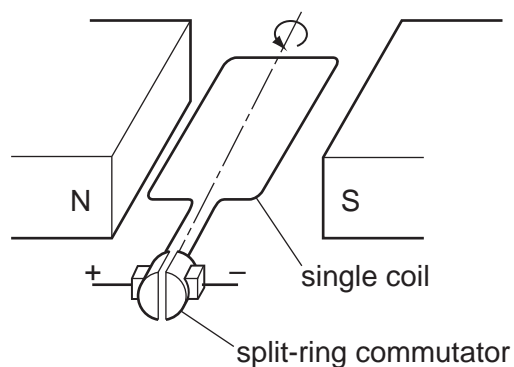

The split-ring commutator reverses the current in the coil as the coil rotates.

The coil is rotated 360° from the position shown.

How many times is the current in the coil reversed?

A 1

B 2

C 3

D 4

34 A conductor is moving horizontally across a vertical magnetic field.

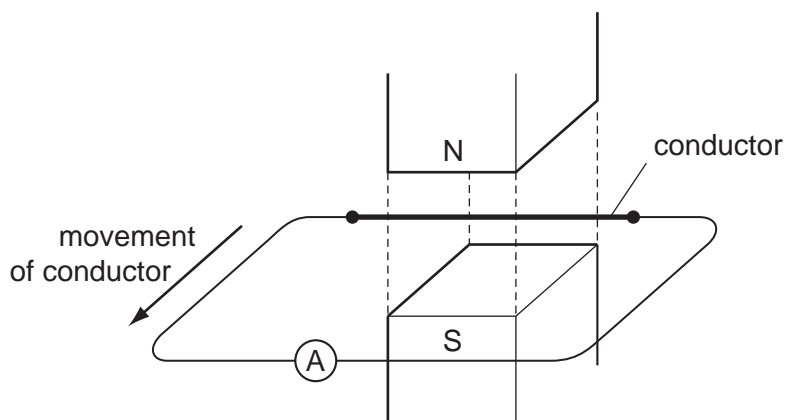

An e.m.f. is induced in the conductor. No deflection is seen on the ammeter.

What is the reason for this?

- A The ammeter is not between the poles.
- B The conductor is moving too slowly.
- C The conductor is not cutting field lines.
- D The poles are too close together.

35 The diagrams show three generators.

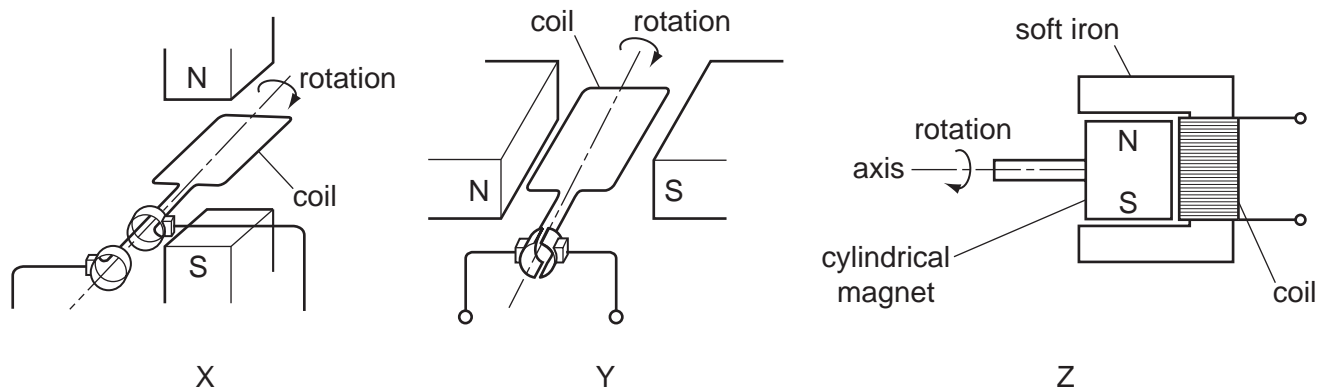

Which are alternating current generators?

- A X only
- B Y only
- C X and Y only
- D X and Z only

36 Which transformer arrangement produces an output voltage that is larger than the input voltage?

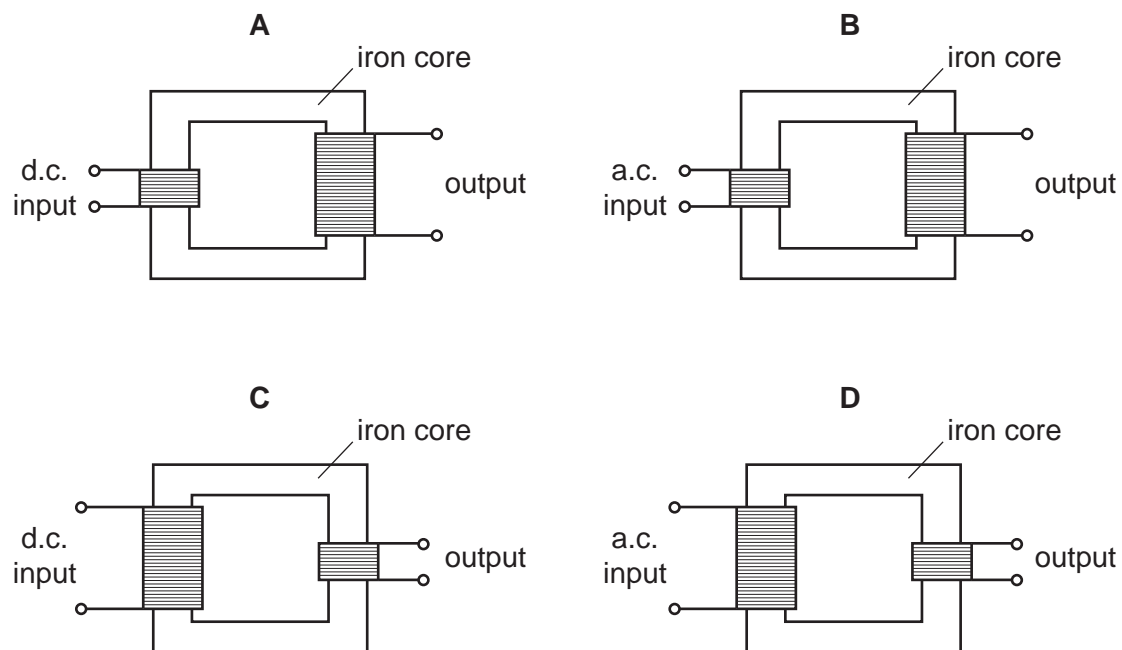

37 The diagram shows a thermistor connected in a potential divider circuit.

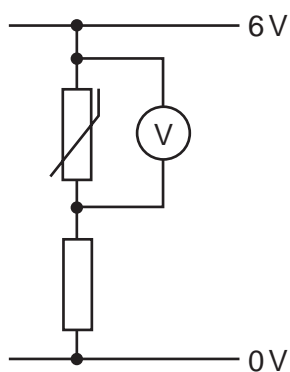

The resistance of the thermistor decreases when its temperature rises. The thermistor is heated.

What happens to the potential difference across the thermistor as it is heated?

- A It decreases but not to zero.
- B It decreases to zero.
- C It increases.
- D It stays the same.

38 Which travels in a straight line across a magnetic field?

- A alpha-particle
- B electron
- C gamma-ray
- D proton

39 In the treatment of brain cancer, a patient's head is enclosed in a helmet containing a number of radioactive sources. The radiation from each source is directed towards the cancer.

Which nuclide is the most suitable for these sources?

	nuclide	radiation	half-life
A	caesium-137	gamma	30 years
B	sodium-24	beta	15 hours
C	strontium-90	beta	29 years
D	californium-246	alpha	36 hours

40 A nucleus of the element cobalt may be represented by the symbol ${}_{27}^{59}\text{Co}$.

What is the structure of this nucleus?

	number of protons	number of neutrons
A	27	32
B	27	59
C	59	27
D	59	32

BLANK PAGE

Permission to reproduce items where third-party owned material protected by copyright is included has been sought and cleared where possible. Every reasonable effort has been made by the publisher (UCLES) to trace copyright holders, but if any items requiring clearance have unwittingly been included, the publisher will be pleased to make amends at the earliest possible opportunity.

University of Cambridge International Examinations is part of the Cambridge Assessment Group. Cambridge Assessment is the brand name of University of Cambridge Local Examinations Syndicate (UCLES), which is itself a department of the University of Cambridge.