

CAMBRIDGE INTERNATIONAL EXAMINATIONS
General Certificate of Education Ordinary Level

PHYSICS

5054/01

Paper 1 Multiple Choice

May/June 2003

1 hour

Additional Materials: Multiple Choice Answer Sheet
Soft clean eraser
Soft pencil (type B or HB is recommended)

READ THESE INSTRUCTIONS FIRST

Write in soft pencil.

Do not use staples, paper clips, highlighters, glue or correction fluid.

Write your name, Centre number and candidate number on the Answer Sheet in the spaces provided unless this has been done for you.

There are **forty** questions on this paper. Answer **all** questions. For each question there are four possible answers **A, B, C, and D**.

Choose the **one** you consider correct and record your choice in **soft pencil** on the separate Answer Sheet.

Read the instructions on the Answer Sheet very carefully.

Each correct answer will score one mark. A mark will not be deducted for a wrong answer.

Any rough working should be done in this booklet.

This document consists of **18** printed pages and **2** blank pages.



- 1 The diagram shows part of a vernier scale.

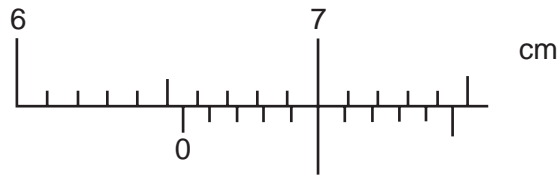

What is the reading on the vernier scale?

- A 6.50 cm
 B 6.55 cm
 C 7.00 cm
 D 7.45 cm
- 2 An object is falling under gravity with terminal velocity.
 What is happening to its speed?
- A It is decreasing to a lower value.
 B It is decreasing to zero.
 C It is increasing.
 D It is staying constant.
- 3 On the Earth, the gravitational field strength is 10 N/kg. On the Moon, the gravitational field strength is 1.6 N/kg.
 If an object has a weight of 50 N on Earth, what is its weight on the Moon?
- A 1.6 N B 5.0 N C 8.0 N D 80 N
- 4 Ten identical steel balls, each of mass 27 g, are immersed in a measuring cylinder containing 20 cm³ of water.
 The reading of the water level rises to 50 cm³.
 What is the density of the steel?
- A 0.90 g/cm³ B 8.1 g/cm³ C 9.0 g/cm³ D 13.5 g/cm³

- 5 An extension-load graph is plotted to show the result of increasing the load on a spring.
Which point marks the limit of proportionality for this spring?

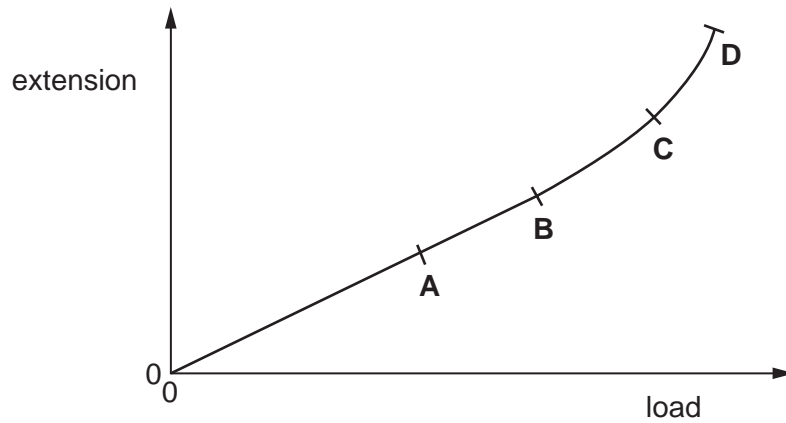

- 6 A person just supports a mass of 20 kg suspended from a rope.

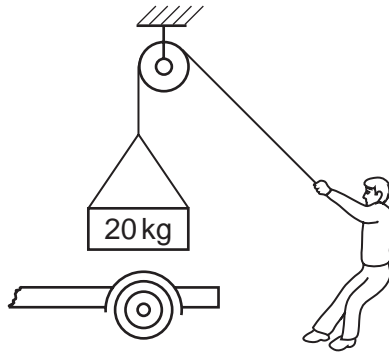

What is the resultant force acting on the mass?

- A 0 N B 10 N C 20 N D 200 N

- 7 A driver's foot presses with a steady force of 20 N on a pedal in a car as shown.

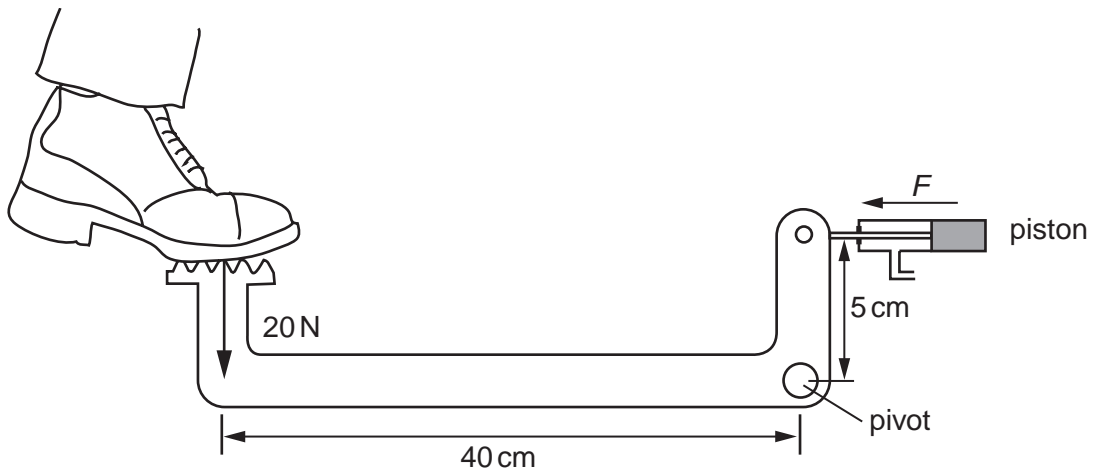

What is the force F pulling on the piston?

- A** 2.5 N **B** 10 N **C** 100 N **D** 160 N
- 8 Which of the following groups of physical quantities consists only of scalars?
- A** acceleration, force, velocity
B acceleration, mass, speed
C force, time, velocity
D mass, speed, time
- 9 Which energy changes take place when a pedalling cyclist uses a generator (dynamo) to light his bicycle lamp?
- A** chemical \rightarrow kinetic \rightarrow electrical \rightarrow light
B electrical \rightarrow chemical \rightarrow kinetic \rightarrow light
C kinetic \rightarrow chemical \rightarrow light \rightarrow electrical
D light \rightarrow electrical \rightarrow kinetic \rightarrow chemical

- 10 A boy, who weighs 50 N, runs up a flight of stairs 6.5 m high in 7 seconds.

How much power does he develop?

- A $\frac{6.5}{50 \times 7} \text{ W}$
B $\frac{7 \times 6.5}{50} \text{ W}$
C $\frac{50}{7 \times 6.5} \text{ W}$
D $\frac{50 \times 6.5}{7} \text{ W}$

- 11 The diagram shows a simple mercury barometer.

Which height is a measure of the atmospheric pressure?

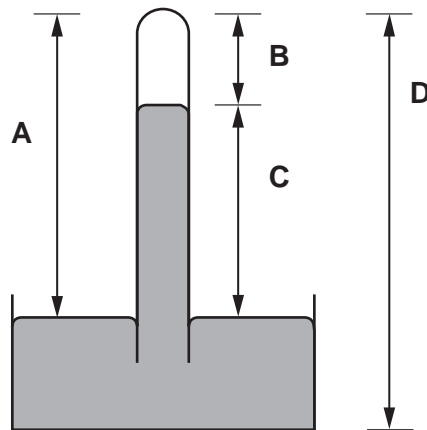

- 12 Bubbles of gas, escaping from the mud at the bottom of a deep lake, rise to the surface.

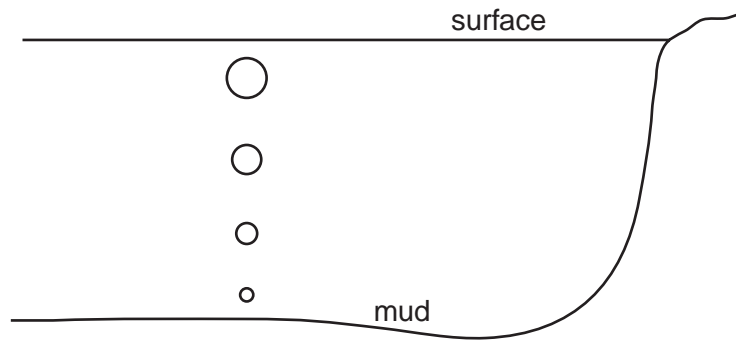

As the bubbles rise they get larger.

Why is this?

- A Atmospheric pressure on the bubbles decreases.
 - B Atmospheric pressure on the bubbles increases.
 - C Water pressure on the bubbles decreases.
 - D Water pressure on the bubbles increases.
- 13 A swimmer climbs out of a swimming pool on a warm, dry day. Almost immediately he begins to feel cold.

Why is this?

- A The water allows a convection current to remove heat from his skin.
- B The water takes latent heat from his body in order to evaporate.
- C The water on his skin is a good conductor of heat.
- D The water prevents infra-red radiation from reaching his body.

- 14 Ice at -10°C is heated at a constant rate until it is water at $+10^{\circ}\text{C}$.

Which graph shows how the temperature changes with time?

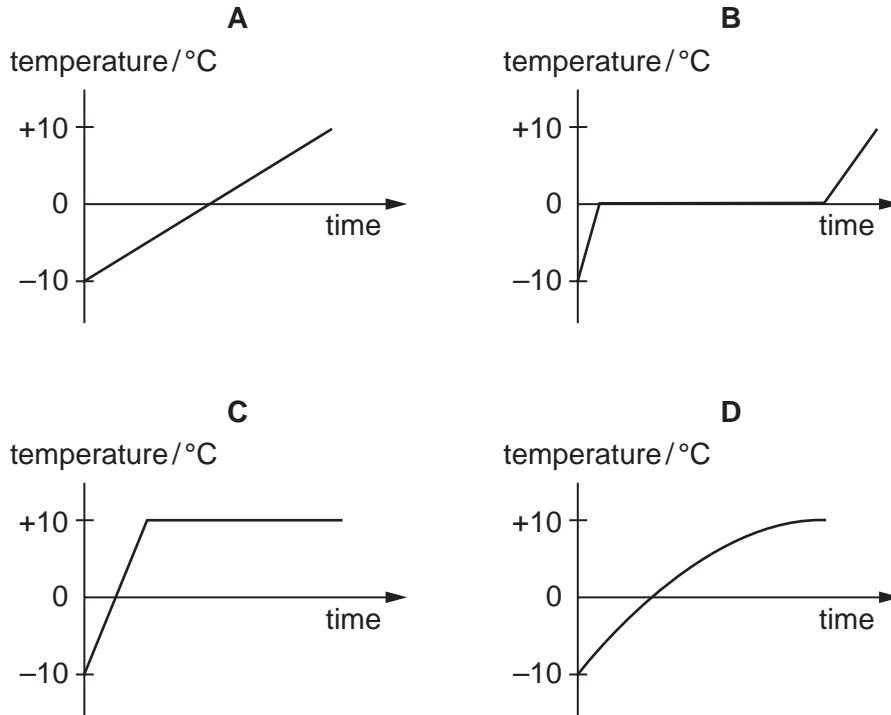

- 15 A clinical thermometer is designed to respond quickly to a change in temperature and to have a high sensitivity.

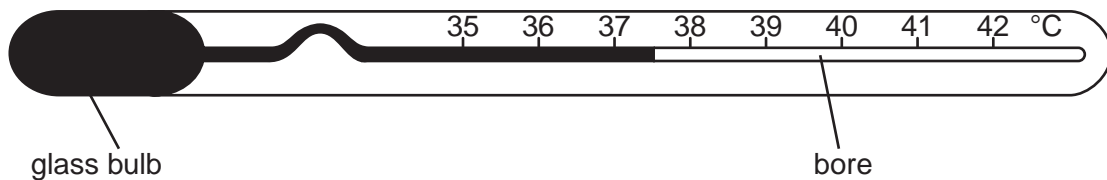

Which design features should the clinical thermometer have?

	bulb	bore
A	thick glass	narrow
B	thick glass	wide
C	thin glass	narrow
D	thin glass	wide

- 16 A glass jug is designed so that it does not break when boiling water is poured into it.

What sort of glass should be used?

	thickness	expansion
A	thick	expands greatly when heated
B	thick	expands little when heated
C	thin	expands greatly when heated
D	thin	expands little when heated

- 17 Which of the following is an example of a transverse and a longitudinal wave?

	transverse wave	longitudinal wave
A	light	water ripples
B	radio	sound
C	sound	light
D	water ripples	radio

- 18 The diagram shows a water wave in a ripple tank.

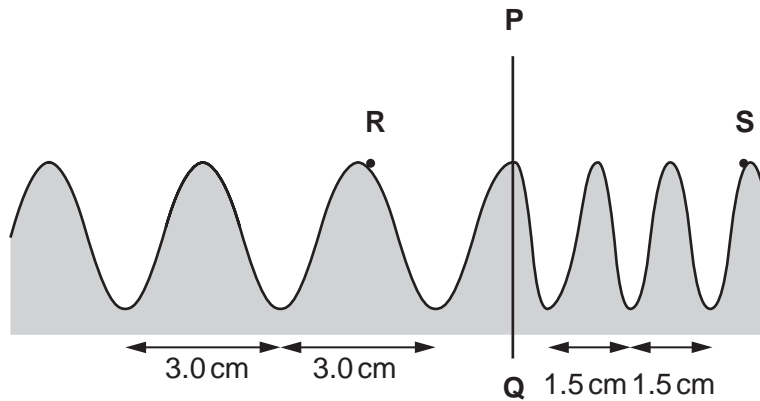

The wave has a speed of 12 cm/s at **R**.

The wave crosses a boundary **PQ** where the distance between crests changes from 3.0 cm to 1.5 cm.

What is the velocity of the wave at point **S**?

- A** 3.0 cm/s
- B** 6.0 cm/s
- C** 12 cm/s
- D** 24 cm/s

- 19 A boy stands beside a girl in front of a large plane mirror. They are both the same distance from the mirror, as shown.

Where does the boy see the girl's image?

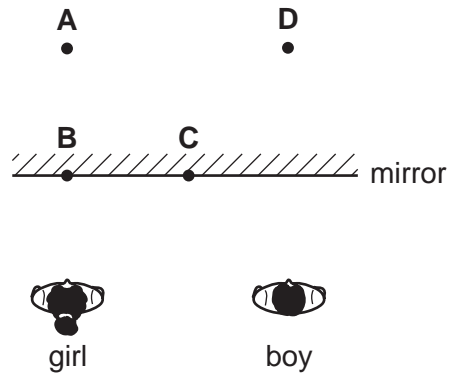

- 20 A ray of light is incident on one side of a rectangular glass block. Its path is plotted through the block and out through another side. Which path is **not** possible?

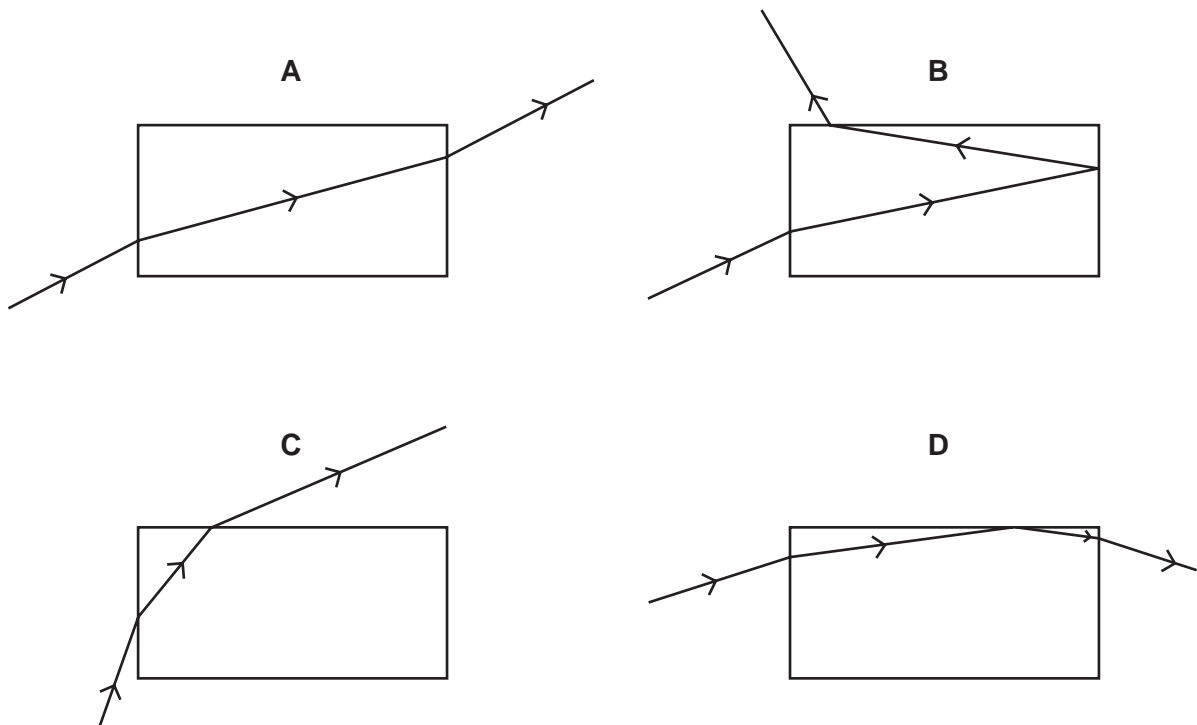

- 21 What is true for real images formed by a converging lens?
- A They are inverted.
 - B They are on the same side of the lens as the object.
 - C They can never be shown on a screen.
 - D They cannot be seen by the human eye.
- 22 The sounds produced by two musical instruments are directed towards a microphone connected to an oscilloscope (cro). The waveforms produced on the screen are shown.

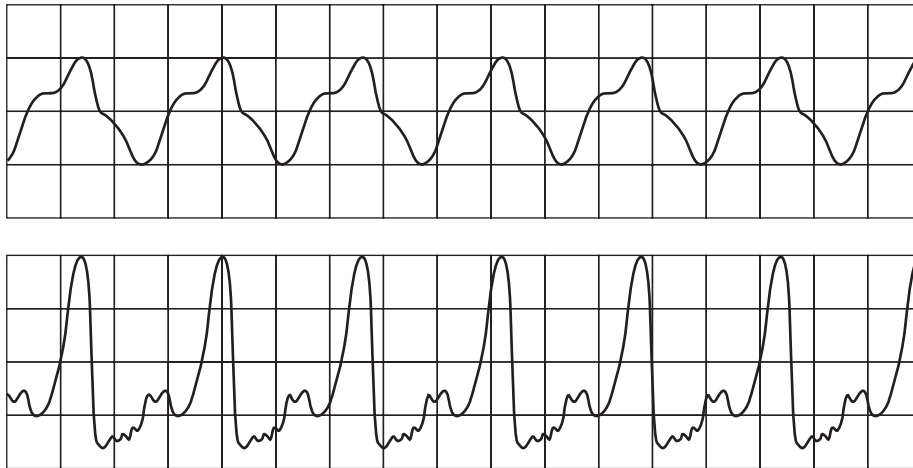

The waveforms show that the sounds produced have a different property.

What is the property?

- A frequency
- B speed
- C timbre (quality)
- D wavelength

- 23 The diagram shows part of a magnetic relay. **M** is part of the core of the magnet. **L** is part of the armature which is attracted to the core when a current flows through the coil. **S** is a stud which stops the armature being attracted too strongly.

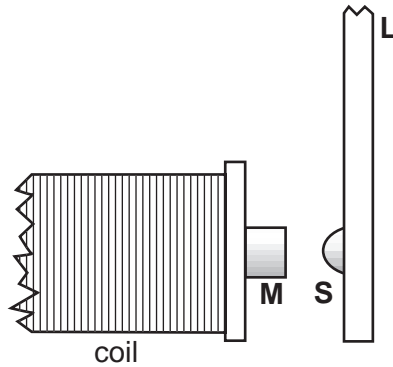

Which line of the table gives the best materials for **M**, **L** and **S**?

	M	L	S
A	iron	iron	iron
B	iron	iron	copper
C	iron	copper	copper
D	copper	copper	copper

- 24 Which diagram correctly shows the electric field between two charged spheres?

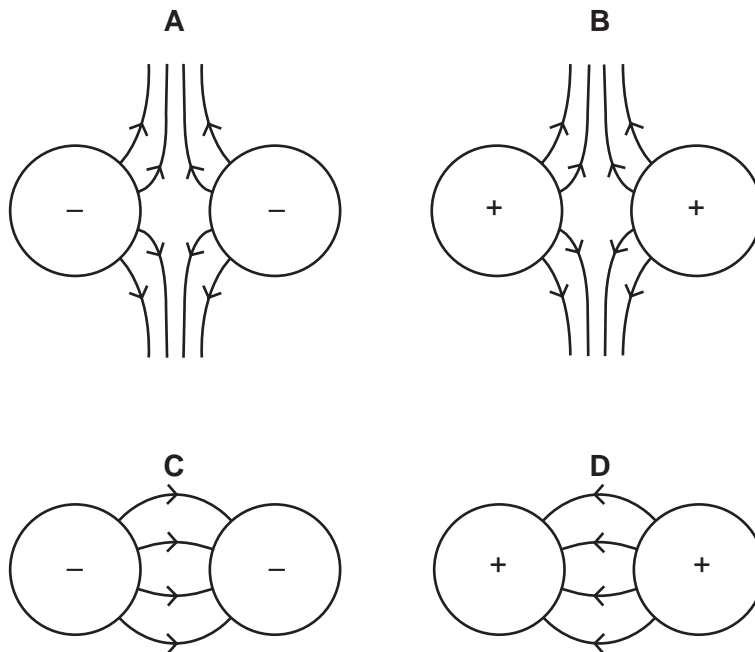

- 25 An electrical quantity is defined as 'the energy converted by a source in driving a unit charge round a complete circuit.'

What is this quantity called?

- A current
- B electromotive force
- C potential difference
- D power

- 26 The diagram shows an electric circuit.

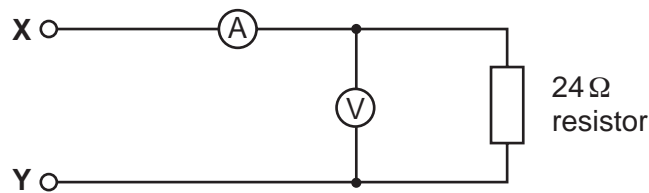

Which pair of readings is obtained when a suitable power supply is connected between X and Y?

	voltmeter	ammeter
A	2 V	6 A
B	2 V	0.5 A
C	12 V	0.5 A
D	12 V	2 A

- 27 The diagram shows part of an electric circuit.

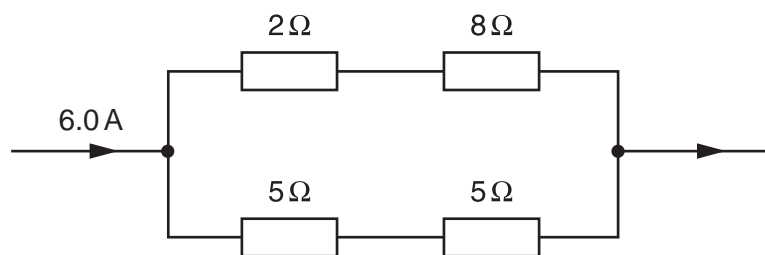

What is the current in the $2\ \Omega$ resistor?

- A 0.6 A
- B 1.2 A
- C 3.0 A
- D 6.0 A

- 28 An electric heater consists of a heating element mounted on a metal reflector. The reflector is connected to earth.

Where should the switch for the heating element be connected?

- A between the earth wire and the reflector
- B between the live wire and the heating element
- C between the live wire and the neutral wire
- D between the neutral wire and the heating element

- 29 Each of the diagrams below is a cross-section through two parallel current-carrying conductors.

Which diagram correctly shows the magnetic field pattern formed by the currents in the two conductors?

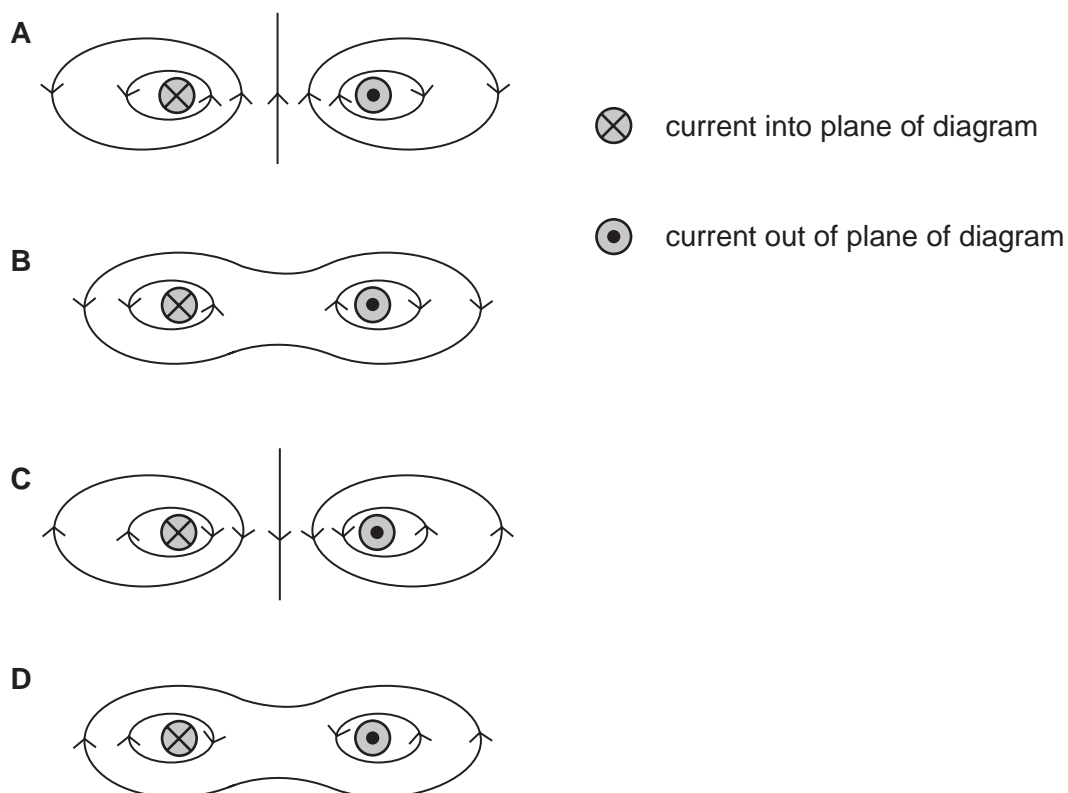

30 A wire hangs between the poles of a magnet.

When there is a current in the wire, in which direction does the wire move?

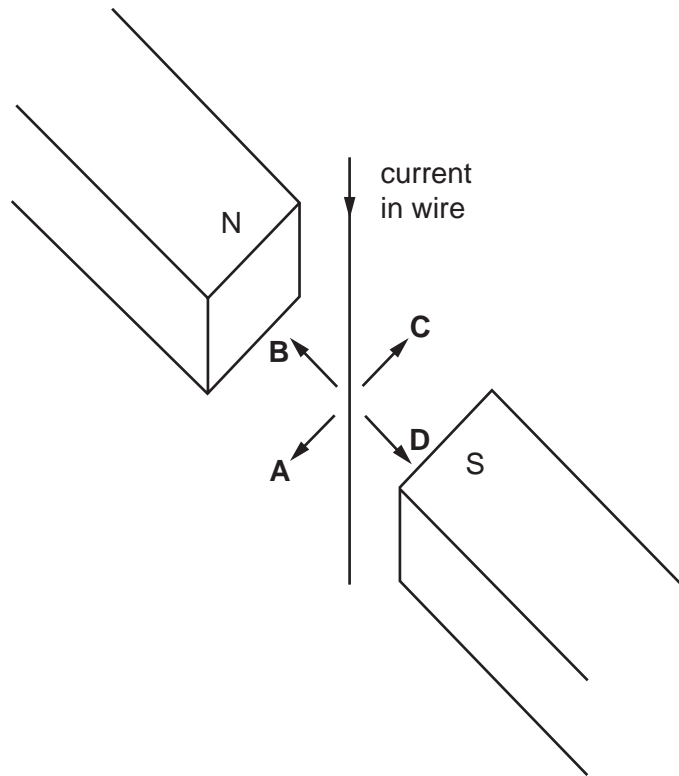

31 What is the part of a simple d.c. motor that reverses the direction of current through the coil every half-cycle?

- A the armature
- B the brushes
- C the commutator
- D the slip rings

32 The number of turns between each pair of output terminals of a transformer is shown in the diagram.

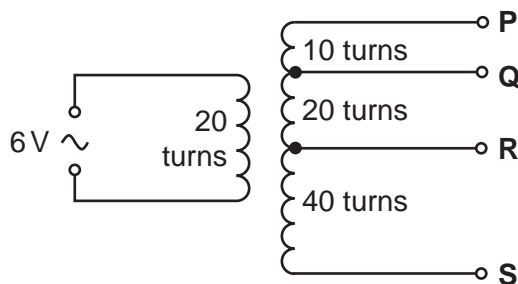

Between which two terminals will the output be 12 V?

- A P and Q
- B Q and R
- C R and S
- D P and R

- 33 Why is electrical energy usually transmitted at high voltage?
- A As little energy as possible is wasted in the transmission cables.
 B The current in the transmission cables is as large as possible.
 C The resistance of the transmission cables is as small as possible.
 D The transmission system does not require transformers.
- 34 The diagram shows a metal bar swinging like a pendulum across a uniform magnetic field. The motion induces an e.m.f. between the ends of the bar.

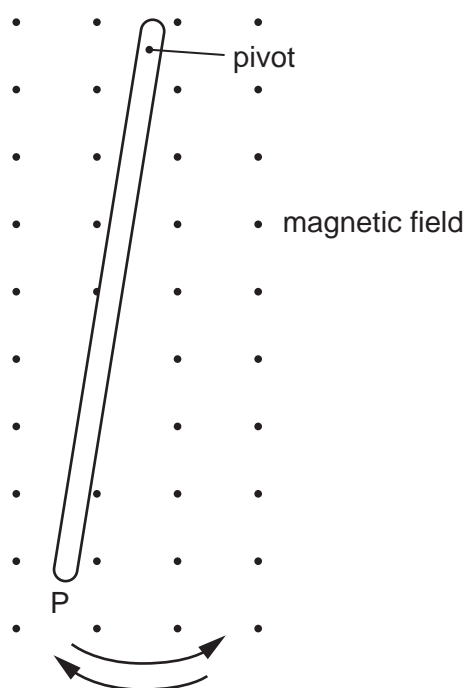

Which graph represents this e.m.f. during one complete oscillation of the bar, starting and finishing at P?

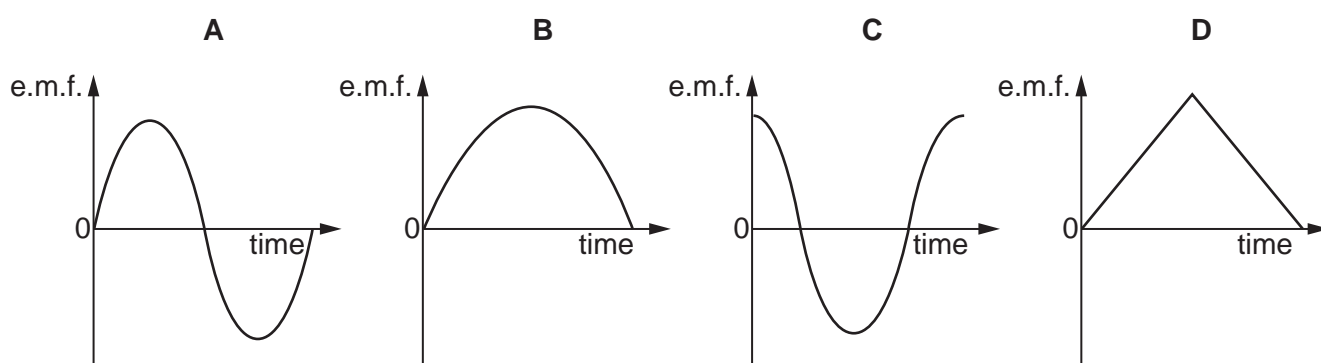

- 35 Diagram 1 shows the oscilloscope trace produced by an input of 2 V at 50 Hz.

diagram 1

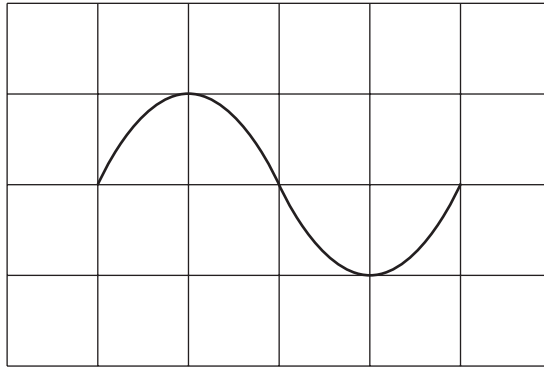
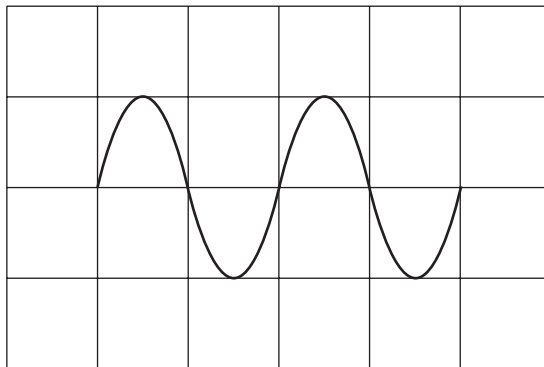

Diagram 2 shows the trace from a different input on the same oscilloscope.

diagram 2



What is the value of the new input?

- A 1 V at 50 Hz
- B 2 V at 25 Hz
- C 2 V at 100 Hz
- D 4 V at 50 Hz

- 36 The electric circuit shown is used to study the charging of capacitor C.

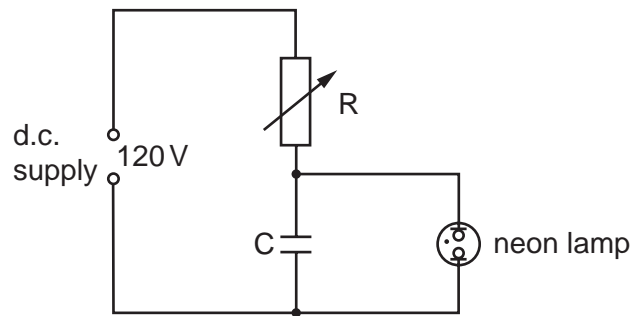

The neon lamp lights when the p.d. across the capacitor C reaches 110 V. The capacitor C then discharges, the lamp goes out and the p.d. across C slowly increases once more.

What is the effect of increasing the resistance of R?

- A The lamp lights up and goes out at the same rate.
 - B The lamp lights up and goes out less frequently.
 - C The lamp lights up and goes out more frequently.
 - D The lamp will not go out at all.
- 37 In a fission reactor, which particle causes a Uranium-235 nucleus to split?
- A alpha-particle
 - B gamma ray
 - C neutron
 - D proton
- 38 A radioactive isotope has a half-life of 2 minutes.

What can be deduced from this statement?

- A After $\frac{1}{2}$ minute, $\frac{1}{4}$ of the isotope remains.
- B After 1 minute, $\frac{1}{4}$ of the isotope remains.
- C After 4 minutes, $\frac{1}{4}$ of the isotope remains.
- D After 4 minutes, none of the isotope remains.

39 The diagram shows how the thickness of paper is measured during manufacture.

If the sheet is too thick, fewer beta-particles can reach the detector.

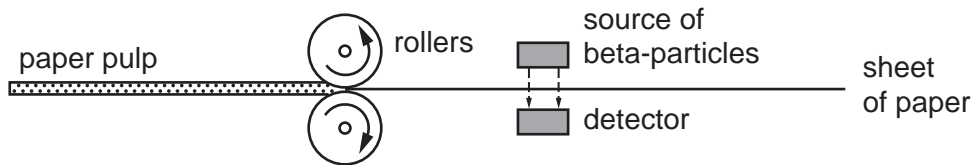

A source of alpha-particles is **not** used for this purpose because alpha-particles

- A are all stopped by the paper.
 - B are too dangerous to those working nearby.
 - C have a short half-life.
 - D make the paper radioactive.
- 40 The results of the Geiger-Marsden scattering experiment provided evidence for the presence of the nucleus within the atom.

What were scattered in this experiment?

- A alpha-particles
- B beta-particles
- C gamma rays
- D gold nuclei

