

Centre Number	Candidate Number	Name
---------------	------------------	------

UNIVERSITY OF CAMBRIDGE INTERNATIONAL EXAMINATIONS
General Certificate of Education Ordinary Level

CHEMISTRY

5070/04

Paper 4 Alternative to Practical

October/November 2006

1 hour

Candidates answer on the Question Paper.
No Additional Materials are required.

READ THESE INSTRUCTIONS FIRST

Write your Centre number, candidate number and name on all your work you hand in.
Write in dark blue or black pen.
You may use a pencil for any diagrams, graphs or rough working.
Do not use staples, paper clips, highlighters, glue or correction fluid.

Answer **all** questions.

At the end of the examination, fasten your work securely together.

The number of marks is given in brackets [] at the end of each question or part question.

For Examiner's Use

This document consists of **16** printed pages.



- 1 Name the apparatus shown below.



answer

[1]

- 2 (a) Ammonia and hydrogen chloride are each passed into different samples of water and a few drops of litmus solution added to each.

Describe the colour of the litmus

- (i) in the ammonia solution,

.....

- (ii) in the hydrogen chloride solution.

.....

- (iii) By what name is aqueous hydrogen chloride more commonly known?

.....

[3]

- (b) Two pieces of cotton-wool, soaked separately in concentrated aqueous solutions of ammonia ($M_r = 17$) and hydrogen chloride ($M_r = 36.5$) were placed at opposite ends of a horizontal tube, as shown in the diagram below.

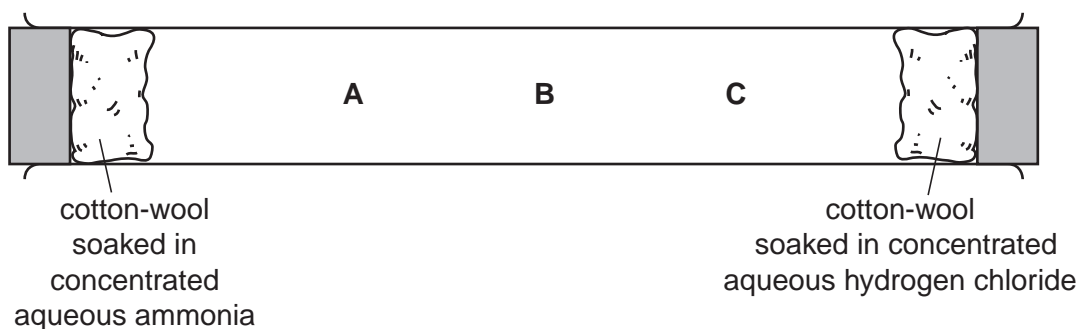

After a few minutes, a white solid was produced on the side of the tube.

- (i) At which position, **A**, **B** or **C**, was the white solid formed? Explain your answer.

position

explanation

.....

(ii) What process was occurring in the tube **before** the white solid was formed?

.....

(iii) Name and give the formula of the white solid.

name

formula

[5]

(c) Suggest which method of collection, **X**, **Y** or **Z**, is most suitable for each of the gases. Explain your answers.

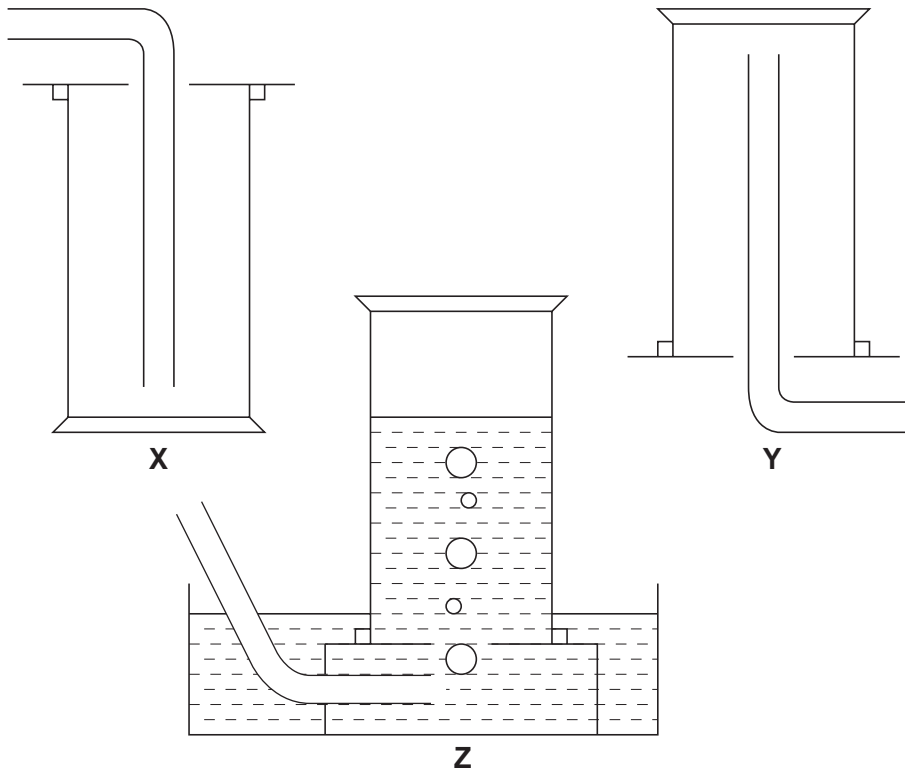

NH_3

HCl

explanation

.....

..... [3]

- 3 A student used the apparatus shown below to produce propanoic acid, C_2H_5COOH .

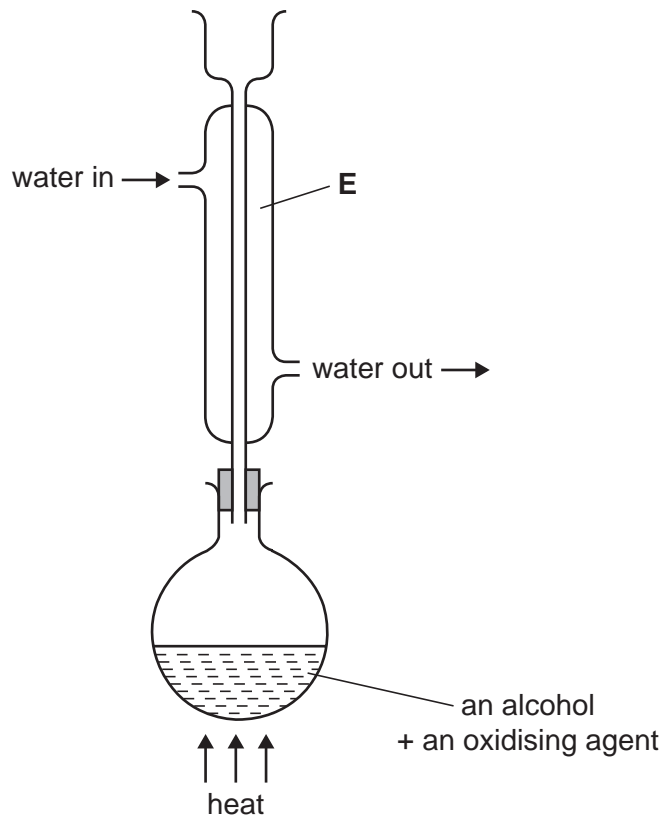

- (a) Study the diagram and state what error the student made in setting up the apparatus.

..... [1]

- (b) Name the piece of apparatus marked **E** and state its purpose.

name

purpose [2]

(c) A small volume of an alcohol was placed in the flask together with an oxidising agent. The mixture was warmed and a colour change was observed in the flask.

(i) Draw the structure of the alcohol required to produce propanoic acid, C_2H_5COOH .

(ii) Suggest a suitable oxidising agent.

.....

(iii) What colour change was observed?

.....

[4]

(d) The student found that a different alcohol, although having the same formula, did not give a carboxylic acid as the product. Suggest the name **and** structure of this alcohol.

name

structure

[2]

In questions 4 to 8, place a tick in the box against the best answer.

- 4 The equation for the reaction between sodium hydroxide and sulphuric acid is shown below.

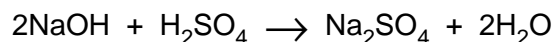

A student placed 25.0 cm^3 of 0.10 mol/dm^3 aqueous sodium hydroxide in a flask. A few drops of an indicator were added. Aqueous sulphuric acid was added from a burette until the end-point was reached.

Which of the following amounts of sulphuric acid would exactly neutralise the aqueous solution of sodium hydroxide in the flask?

- (a) 25.0 cm^3 of 0.050 mol/dm^3
- (b) 25.0 cm^3 of 0.10 mol/dm^3
- (c) 50.0 cm^3 of 0.050 mol/dm^3
- (d) 50.0 cm^3 of 0.10 mol/dm^3

[1]

5 A student did two experiments to produce hydrogen.

Experiment 1

5.0 g of granulated zinc (an excess) and 10 cm³ of 1.0 mol/dm³ hydrochloric acid

Experiment 2

5.0 g of powdered zinc (an excess) and 20 cm³ of 1.0 mol/dm³ hydrochloric acid

The temperature was the same at the start of each experiment. Graphs were drawn of the volume of hydrogen produced against time.

Which two graphs best represent the two experiments?

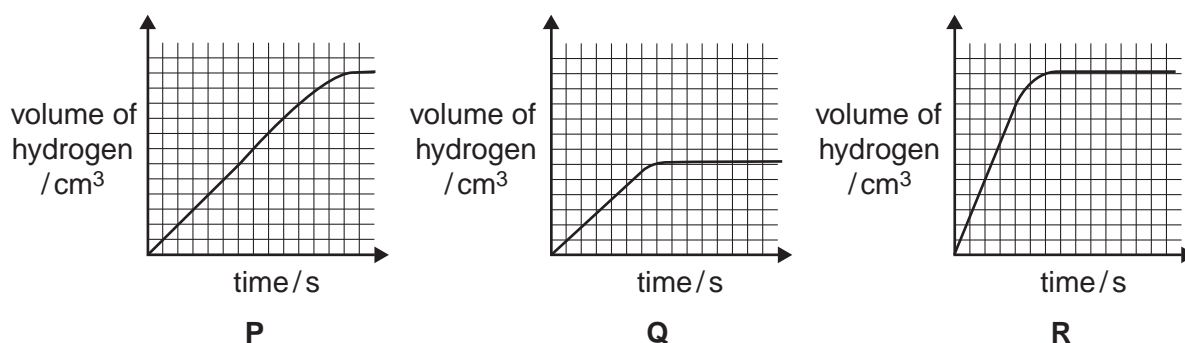

	experiment 1	experiment 2	
(a)	P	Q	<input type="checkbox"/>
(b)	P	R	<input type="checkbox"/>
(c)	Q	R	<input type="checkbox"/>
(d)	Q	P	<input type="checkbox"/>

[1]

- 6 A student prepared ethene using the apparatus shown below.

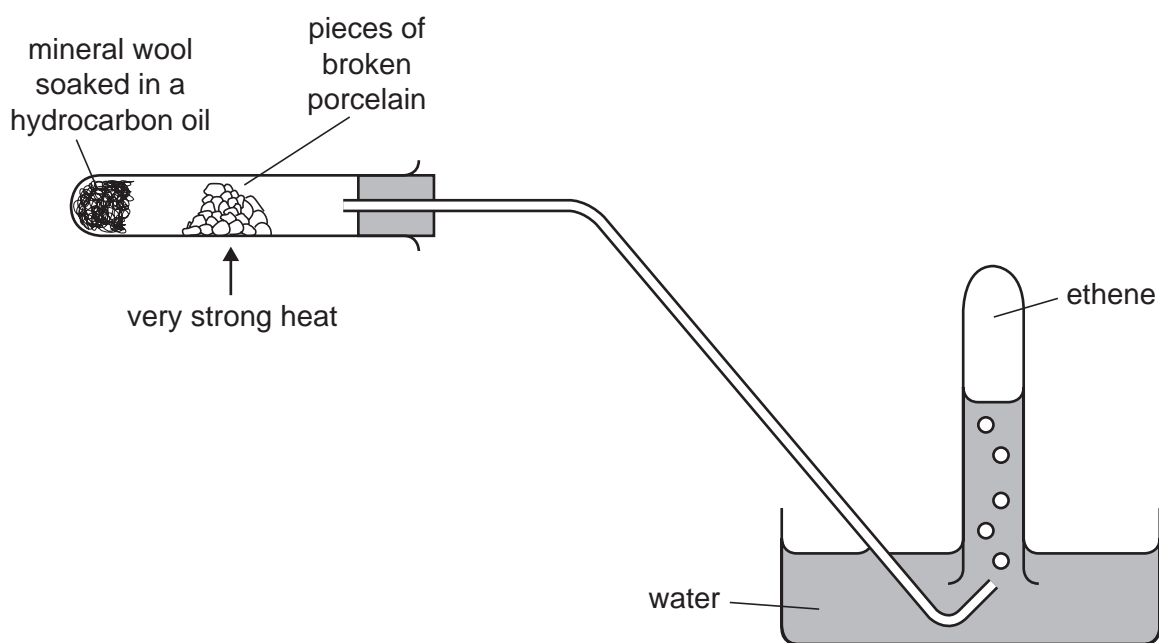

This method of preparation is

(a) cracking.

(b) dehydration.

(c) hydrolysis.

(d) reduction.

[1]

- 7 A student electrolysed aqueous copper(II) sulphate using copper electrodes.

Which of the following sets of observations was correct?

	anode (+ve)	cathode (-ve)	final colour of solution	
(a)	copper electrode reduced in size	copper deposited	blue	<input type="checkbox"/>
(b)	oxygen produced	copper deposited	colourless	<input type="checkbox"/>
(c)	oxygen produced	hydrogen produced	colourless	<input type="checkbox"/>
(d)	copper electrode reduced in size	hydrogen produced	blue	<input type="checkbox"/>

[1]

- 8 Four test-tubes were set up as shown in the diagram. Each piece of iron was protected on one side only by a different coating.

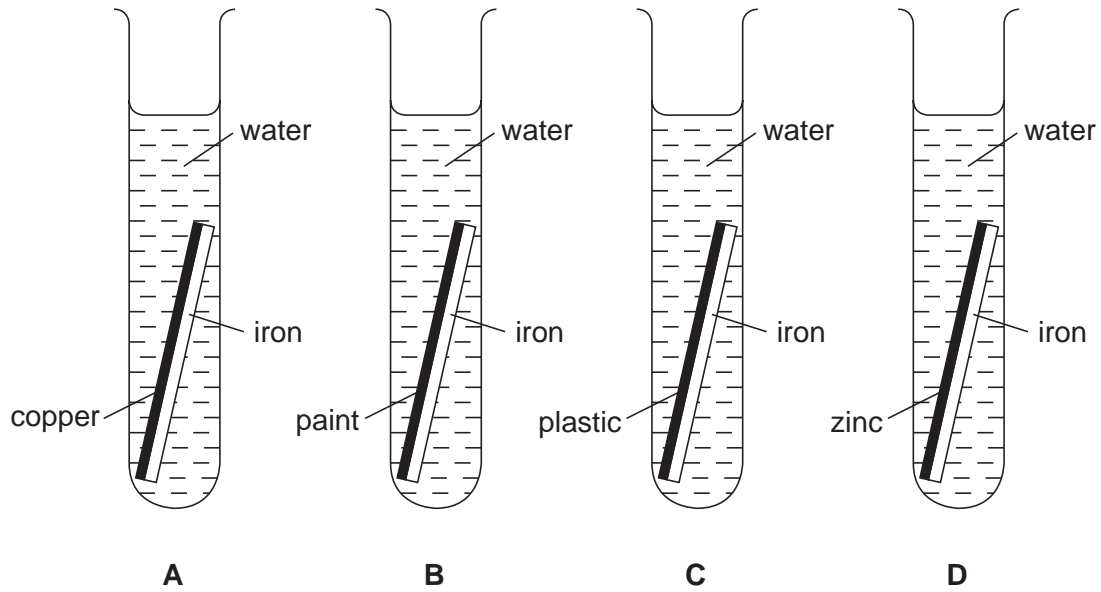

In which test-tube is the iron **least** likely to rust?

- (a) A
- (b) B
- (c) C
- (d) D

[1]

- 9 Substance **L** is a fertiliser. It contains three ions, one of which is the ammonium ion, NH_4^+ . The student was asked to do two experiments.

Experiment A

Carry out tests on **L** to find which ions are present.

Experiment B

Determine the mass of ammonia produced on heating a sample of **L** with sodium hydroxide.

Experiment A

The following table shows the tests the student did on **L**.

Complete the table by stating the conclusions in tests **1**, **2(a)** and **2(b)** and suggest the tests and observations which led to the conclusions in tests **2(c)** and **3**.

test	observations	conclusions
1 L was dissolved in water and the solution divided into two parts for tests 2 and 3 .	A coloured solution was produced.	
2 (a) To the first part of the solution in a test-tube, aqueous sodium hydroxide was added until a change was seen.	A green precipitate was produced.	
(b) An excess of aqueous sodium hydroxide was added to the mixture from (a) .	The green precipitate was insoluble in an excess of aqueous sodium hydroxide.	
(c)		L contains NH_4^+ ions.
3		L contains SO_4^{2-} ions.

[8]

Experiment B

- (a) The student added a sample of L to a previously weighed container, which was then reweighed.

$$\begin{aligned} \text{mass of container and L} &= 14.19 \text{ g} \\ \text{mass of container} &= 9.46 \text{ g} \end{aligned}$$

Calculate the mass of L used in the experiment.

..... g [1]

The sample was placed in a beaker and 50.0 cm^3 of 1.00 mol/dm^3 sodium hydroxide (an excess) was added.

The mixture was heated until all the ammonia was evolved.

The equation for the reaction is

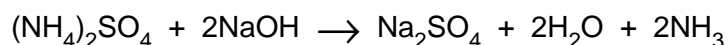

- (b) The remaining mixture, which contained an excess of sodium hydroxide, was transferred to a graduated flask and made up to 250 cm^3 with distilled water. This was solution M.

25.0 cm^3 of M was transferred to a titration flask and a few drops of methyl orange were added.

A burette was filled with a solution containing 0.100 mol/dm^3 hydrochloric acid. This solution was run into the titration flask until an end-point was reached.

What was the colour change of the indicator at the end-point?

The colour changed from to [1]

Three titrations were done. The diagrams below show parts of the burette with the liquid levels at the beginning and end of each titration.

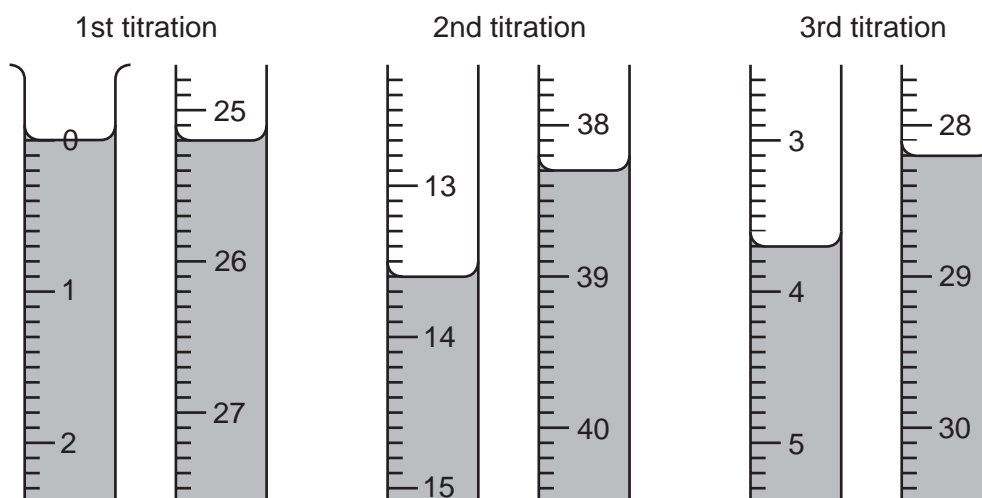

(c) Use the diagrams to complete the following table.

titration number	1	2	3
final reading / cm ³			
initial reading / cm ³			
volume of hydrochloric acid used / cm ³			
best titration results (✓)			

Summary

Tick (✓) the best titration results. Using these results, the average volume of hydrochloric acid used was cm³. [4]

(d) Calculate the number of moles of hydrochloric acid in the average volume of 0.100 mol/dm³ hydrochloric acid in (c).

..... moles [1]

(e) Using the equation

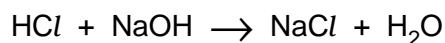

deduce the number of moles of sodium hydroxide in 25.0 cm³ of solution **M**.

..... moles [1]

(f) Using your answer in (e), calculate the number of moles of sodium hydroxide in 250 cm³ of solution **M**.

..... moles [1]

- (g) Calculate the number of moles of sodium hydroxide in 50.0 cm^3 of 1.00 mol/dm^3 sodium hydroxide.

..... moles [1]

- (h) By subtracting your answer in (f) from your answer in (g), calculate the number of moles of sodium hydroxide which reacted with the sample of L.

..... moles [1]

- (i) Given that one mole of sodium hydroxide produces 17 g of ammonia, use your answer to (h) to calculate the mass of ammonia produced from the original sample of L.

..... g [1]

- (j) Using your answers to (i) and (a), calculate the mass of ammonia which can be produced from 1 kg of L.

..... g [1]

10 When potassium chlorate(V) is heated it decomposes and oxygen is evolved.

(a) Give a test for oxygen.

..... [1]

Experiment 1

A student placed a sample of potassium chlorate(V) in the apparatus shown below. The tube was heated steadily for three minutes. The total volume of oxygen produced was measured every thirty seconds and the results were recorded in the table.

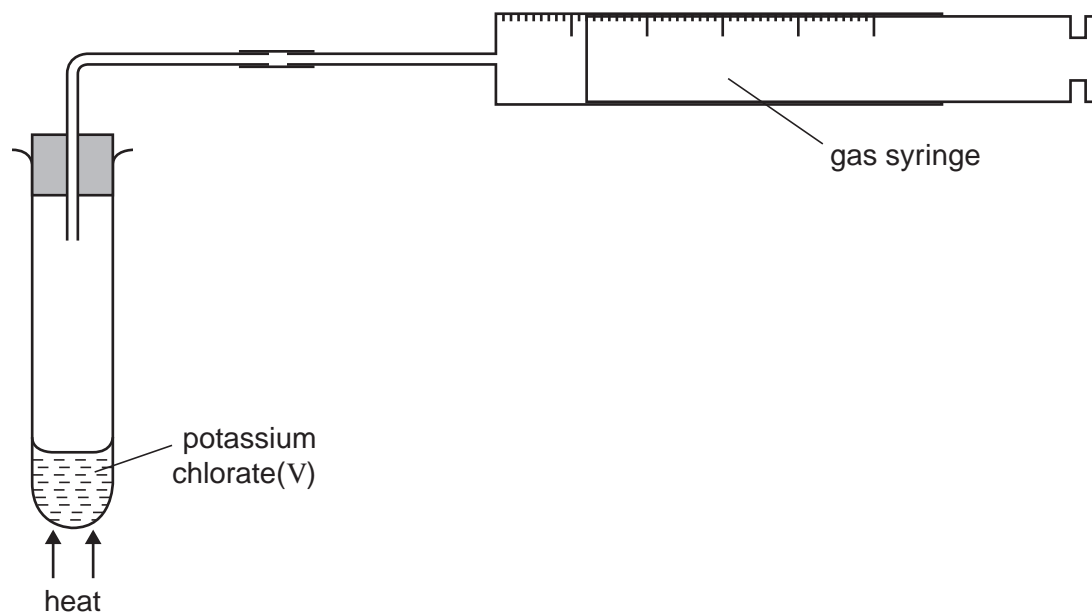

Experiment 2

The experiment was repeated using the same mass of potassium chlorate(V) to which a small amount of copper(II) oxide had been added. All other conditions were kept constant.

The diagrams of the gas syringe below show the volume of oxygen produced in experiment 2 after 30, 60, 90 and 120 seconds respectively.

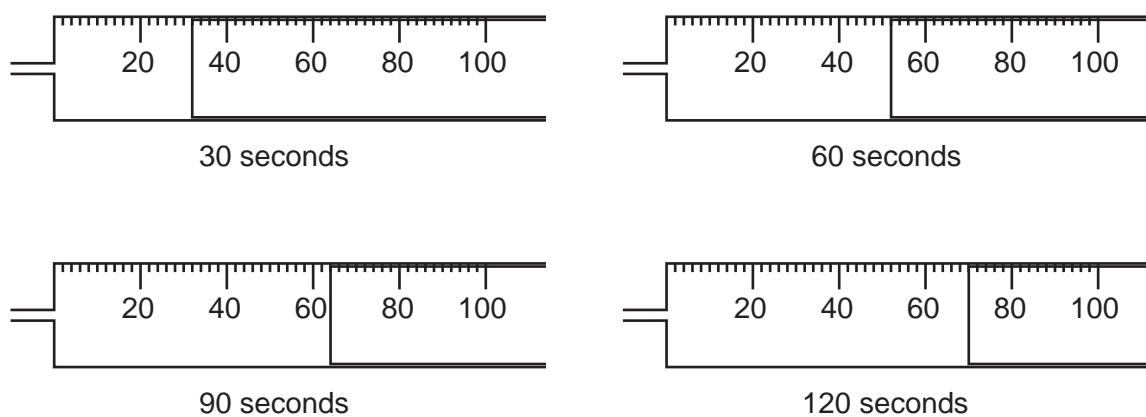

(b) Complete the table using the volumes of oxygen as shown in the diagrams.

time / s	volume of oxygen collected / cm ³ experiment 1	volume of oxygen collected / cm ³ experiment 2
30	22	
60	40	
90	54	
120	64	
150	70	72
180	72	72

[2]

(c) Plot the results for both experiment 1 and experiment 2 on the grid below and draw a smooth curve through each set of points. Label the respective curves 'experiment 1' and 'experiment 2'.

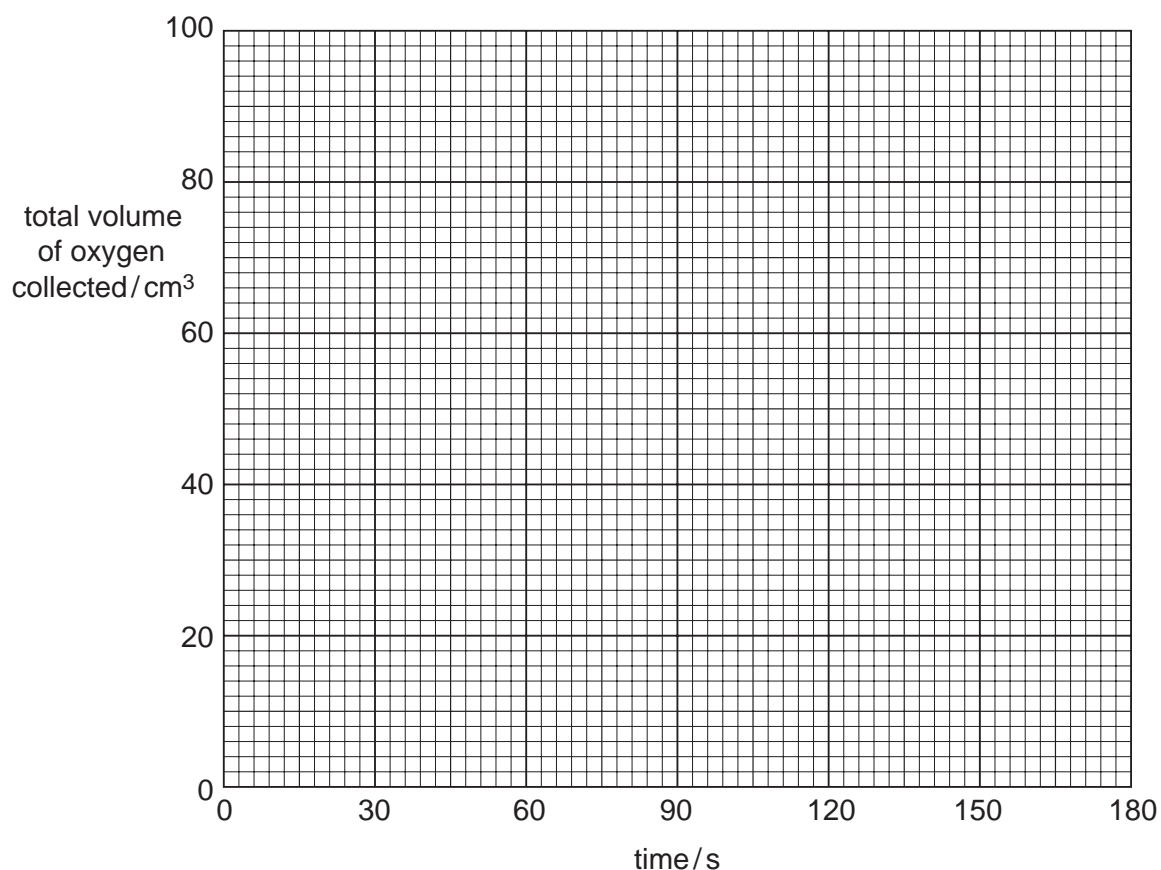

[3]

Use your graphs to answer the following questions.

- (d) (i) What volume of oxygen was produced in experiment 1 after 45 seconds?

..... cm³

- (ii) How much more oxygen was produced after 75 seconds in experiment 2 than in experiment 1? Show your working.

..... cm³

[3]

- (e) Why was copper(II) oxide used in experiment 2?

.....

..... [1]

- (f) (i) Why were the last two readings recorded in the table for experiment 2 the same?

.....

.....

- (ii) The equation for the reaction is

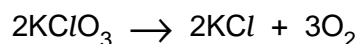

By referring to your results in the table, calculate the mass of potassium chlorate used in the experiment, showing your working.

[1 mole of a gas has a volume of 24 dm³ at 25 °C.]

[A_r: K, 39; Cl, 35.5; O, 16]

..... g

[3]

Permission to reproduce items where third-party owned material protected by copyright is included has been sought and cleared where possible. Every reasonable effort has been made by the publisher (UCLES) to trace copyright holders, but if any items requiring clearance have unwittingly been included, the publisher will be pleased to make amends at the earliest possible opportunity.

University of Cambridge International Examinations is part of the University of Cambridge Local Examinations Syndicate (UCLES), which is itself a department of the University of Cambridge.