



UNIVERSITY OF CAMBRIDGE INTERNATIONAL EXAMINATIONS  
General Certificate of Education Ordinary Level

---

**CHEMISTRY**

**5070/11**

Paper 1 Multiple Choice

**May/June 2013**

**1 hour**

Additional Materials: Multiple Choice Answer Sheet  
Soft clean eraser  
Soft pencil (type B or HB is recommended)



---

**READ THESE INSTRUCTIONS FIRST**

Write in soft pencil.

Do not use staples, paper clips, highlighters, glue or correction fluid.

Write your name, Centre number and candidate number on the Answer Sheet in the spaces provided unless this has been done for you.

**DO NOT WRITE IN ANY BARCODES.**

There are **forty** questions on this paper. Answer **all** questions. For each question there are four possible answers **A, B, C** and **D**.

Choose the **one** you consider correct and record your choice in **soft pencil** on the separate Answer Sheet.

**Read the instructions on the Answer Sheet very carefully.**

Each correct answer will score one mark. A mark will not be deducted for a wrong answer.

Any rough working should be done in this booklet.

A copy of the Periodic Table is printed on page 16.

Electronic calculators may be used.

---

This document consists of **13** printed pages and **3** blank pages.



1 In which method of separation are  $R_f$  values used?

- A chromatography
- B crystallisation
- C filtration
- D fractional distillation

2 The diagrams show the arrangement of particles in three **solids**: krypton, potassium and sodium chloride.

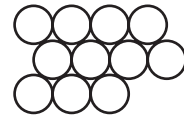
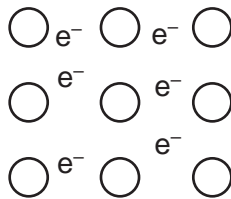
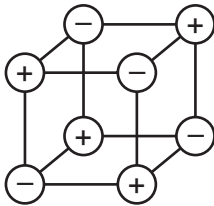

In which order are the solids shown?

- A krypton; potassium; sodium chloride
  - B krypton; sodium chloride; potassium
  - C sodium chloride; krypton; potassium
  - D sodium chloride; potassium; krypton
- 3 In which pair do neither of the gases change the colour of damp blue litmus paper?
- A ammonia and hydrogen
  - B ammonia and hydrogen chloride
  - C carbon dioxide and chlorine
  - D carbon dioxide and sulfur dioxide
- 4 Naturally-occurring bromine has a relative atomic mass of 80 and consists entirely of two isotopes of relative atomic masses 79 and 81.

What can be deduced about naturally-occurring bromine from this information only?

- A Bromine contains the two isotopes in equal proportions.
  - B Bromine has different oxidation states.
  - C Bromine isotopes have different numbers of protons.
  - D Bromine is radioactive.
- 5 Which compound has molecules each of which contains only two covalent bonds?
- A  $\text{CH}_4$
  - B  $\text{H}_2\text{O}$
  - C  $\text{MgCl}_2$
  - D  $\text{Na}_2\text{O}$

- 6 What can be deduced about two gases that have the same relative molecular mass?
- A They have the same boiling point.
  - B They have the same number of atoms in one molecule.
  - C They have the same rate of diffusion at room temperature and pressure.
  - D They have the same solubility in water at room temperature.
- 7 An ionic bond is formed by
- A electron sharing between metals and non-metals.
  - B electron sharing between non-metals.
  - C electron transfer between non-metals.
  - D electron transfer from metals to non-metals.
- 8 Both magnesium oxide, MgO, and aluminium oxide,  $Al_2O_3$ , are solids at room temperature, 25 °C.
- MgO has a melting point of 2852 °C and a boiling point of 3600 °C.
- $Al_2O_3$  has a melting point of 2072 °C and a boiling point of 2880 °C.
- Over which temperature range will both pure compounds conduct electricity?
- A 25 to 2852 °C
  - B 2072 to 2852 °C
  - C 2852 to 2880 °C
  - D 2880 to 3600 °C
- 9 Which substance conducts an electric current but remains chemically unchanged?
- A aluminium
  - B aqueous sodium chloride
  - C molten lead(II) bromide
  - D pure ethanoic acid
- 10 Which statement most clearly indicates that diamond and graphite are forms of carbon?
- A Both are crystalline solids.
  - B Complete combustion of equal masses of both solids produces equal masses of carbon dioxide as the only product.
  - C Graphite conducts electricity whereas diamond is an insulator.
  - D Under suitable conditions graphite can be partially converted into diamond.

11 In an experiment,  $1\text{ cm}^3$  of a gaseous hydrocarbon **X** required  $4\text{ cm}^3$  of oxygen for complete combustion to give  $3\text{ cm}^3$  of carbon dioxide. All gas volumes are measured at r.t.p.

Which formula represents **X**?

- A**  $\text{C}_2\text{H}_2$       **B**  $\text{C}_2\text{H}_4$       **C**  $\text{C}_3\text{H}_4$       **D**  $\text{C}_3\text{H}_8$

12 What is the concentration of a solution containing  $1.0\text{ g}$  of sodium hydroxide in  $250\text{ cm}^3$  of solution?

- A**  $0.025\text{ mol/dm}^3$   
**B**  $0.10\text{ mol/dm}^3$   
**C**  $0.25\text{ mol/dm}^3$   
**D**  $1.0\text{ mol/dm}^3$

13 The diagrams show an electrolysis experiment using inert electrodes.

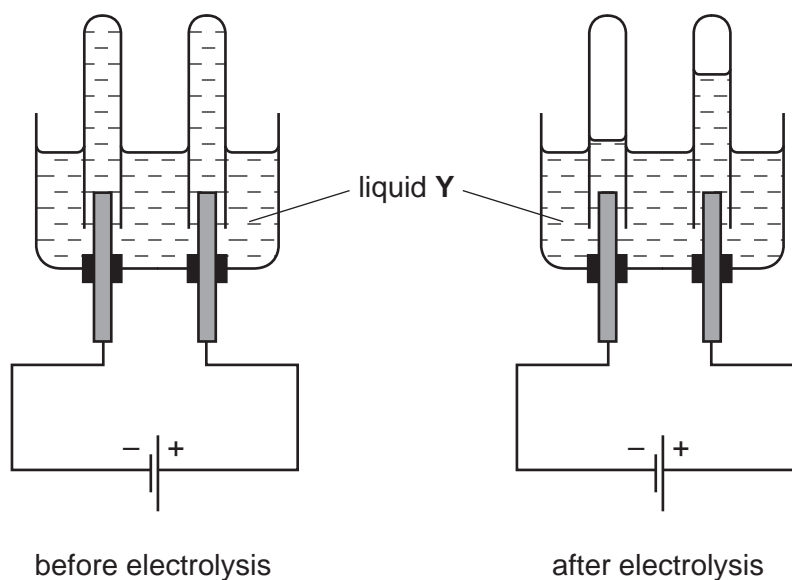

Which could be liquid **Y**?

- A** aqueous copper(II) sulfate  
**B** concentrated aqueous sodium chloride  
**C** dilute sulfuric acid  
**D** ethanol

- 14 Which substance, when added to water, does **not** make a solution that is a good conductor of electricity?
- A barium nitrate  
B calcium chloride  
C lead(II) nitrate  
D zinc carbonate
- 15 A simple cell is shown below.

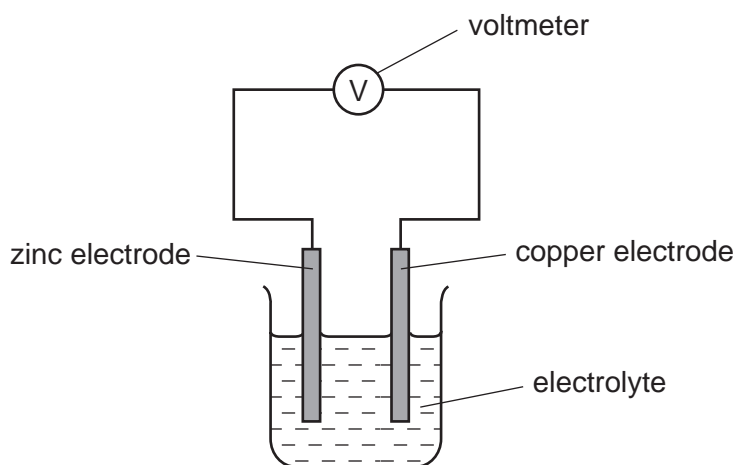

- Which statement about the process occurring when the cell is in operation is correct?
- A  $\text{Cu}^{2+}$  ions are formed in solution.  
B Electrons travel through the solution.  
C The reaction  $\text{Zn} \rightarrow \text{Zn}^{2+} + 2\text{e}^-$  occurs.  
D Zinc increases in mass.
- 16 The usual conditions for the Haber process are 250 atm pressure, 450 °C and an iron catalyst.
- Which change in conditions would give the reactants more energy?
- A addition of more catalyst  
B a decrease in pressure  
C an increase in concentration of the reactants  
D an increase in temperature

17 Chlorine can be manufactured by the following reaction.

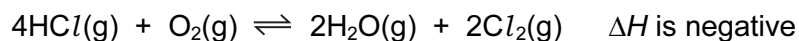

A mixture in dynamic equilibrium is formed.

Which change to the mixture will increase the amount of chlorine at equilibrium?

- A adding a catalyst
- B adding more  $\text{HCl}(\text{g})$
- C decreasing the pressure
- D increasing the temperature

18 Equations for reactions of iron and iron compounds are shown.

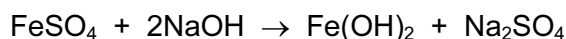
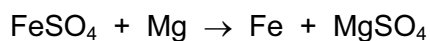
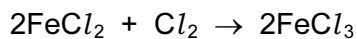
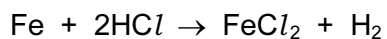

How many of these are redox reactions?

- A 1                      B 2                      C 3                      D 4

19 Which is a use of sulfuric acid?

- A as a bleach
- B in the manufacture of ammonia
- C in the manufacture of fertilisers
- D in the manufacture of sulfur trioxide

20 The table shows the solubility of some compounds of metal Q in cold water.

salt	solubility in cold water
carbonate	insoluble
chloride	soluble
sulfate	insoluble

What is metal Q?

- A barium
- B lead
- C magnesium
- D sodium

21 A metal *M* forms a chloride which dissolves in cold water and has an oxide which dissolves in both strong acids and strong alkalis.

What is *M*?

- A iron
- B lead
- C sodium
- D zinc

22 Which element has a variable oxidation state, can act as a catalyst and forms coloured compounds?

- A carbon
- B iron
- C lead
- D nitrogen

23 An atom of which element has the same electronic configuration as the strontium ion?

- A calcium
- B krypton
- C rubidium
- D selenium

24 The boiling points of gaseous elements increase as the size of their atoms increases.

Which of these noble gases has the highest boiling point?

- A argon
- B helium
- C krypton
- D neon

25 The sentence describes two metals and their oxides.

Metal X could be copper because its oxide is .....1..... and metal Y could be .....2..... because its oxide is amphoteric.

Which words correctly complete gaps 1 and 2?

	1	2
A	acidic	aluminium
B	basic	aluminium
C	acidic	magnesium
D	basic	magnesium

26 Which gas could be used to convert copper(II) oxide to copper?

- A carbon dioxide
- B hydrogen
- C nitrogen
- D oxygen

27 Aluminium and copper are often used to make coins but iron is not.

Which statement explains this?

- A Iron is above both aluminium and copper in the reactivity series.
- B Iron is more expensive to manufacture than aluminium or copper.
- C Iron is rarer than both aluminium and copper.
- D Iron reacts with water.



28 In the electrolysis of molten aluminium oxide for the extraction of aluminium, the following three reactions take place.

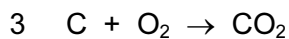
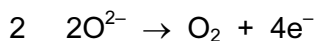
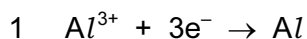

Which reactions take place at the positive electrode?

- A** 1 only      **B** 2 only      **C** 1 and 3 only      **D** 2 and 3 only

29 Which two substances are removed from the bottom of the blast furnace?

1 coke

2 iron

3 limestone

4 slag

- A** 1 and 3      **B** 1 and 4      **C** 2 and 3      **D** 2 and 4

30 An alloy of copper and zinc is added to an excess of dilute hydrochloric acid. The resulting mixture is then filtered.

Which observations are correct?

	filtrate	residue
<b>A</b>	colourless solution	none
<b>B</b>	colourless solution	red-brown
<b>C</b>	blue solution	grey
<b>D</b>	blue solution	none

31 Which aqueous reagent liberates ammonia from ammonium nitrate on warming?

- A** calcium nitrate  
**B** potassium hydroxide  
**C** sodium chloride  
**D** sulfuric acid

32 An aqueous solution of a compound **X** reacts with

- aqueous zinc chloride to form a white precipitate which dissolves when **X** is in excess,
- aluminium sulfate solution to form a white precipitate which is insoluble when **X** is in excess.

What is the identity of **X**?

- A** ammonia
- B** barium chloride
- C** silver nitrate
- D** sodium hydroxide
- 33 CFC compounds were commonly used as aerosol propellants. The structure of one CFC compound is shown.

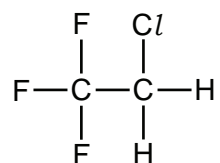

Which element in this compound causes a depletion of ozone in the atmosphere?

- A** carbon
- B** chlorine
- C** fluorine
- D** hydrogen
- 34 Which gas is most likely to react with limestone?
- A** ammonia
- B** carbon monoxide
- C** methane
- D** sulfur dioxide

35 The diagram shows the structure of an ester.

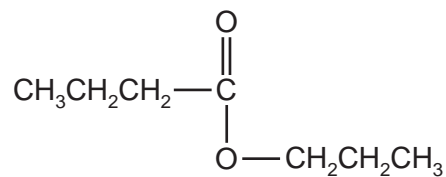

What are the starting materials for making this compound?

- A butanol and butanoic acid
- B butanol and propanoic acid
- C propanol and butanoic acid
- D propanol and propanoic acid

36 Which information is correct regarding the formation of ethanol by the process of fermentation?

	substances fermented	gas evolved during fermentation
A	carbohydrates	carbon dioxide
B	carbohydrates	carbon monoxide
C	hydrocarbons	carbon dioxide
D	hydrocarbons	carbon monoxide

37 Nylon, poly(ethene) and *Terylene* are macromolecules.

In which of these macromolecules is the C=O group present in the linkage?

- A nylon and *Terylene* only
- B nylon only
- C poly(ethene) and *Terylene* only
- D *Terylene* only

38 Which partial structure is correct for the product of polymerisation of butene,  $\text{CH}_2=\text{CHCH}_2\text{CH}_3$ ?

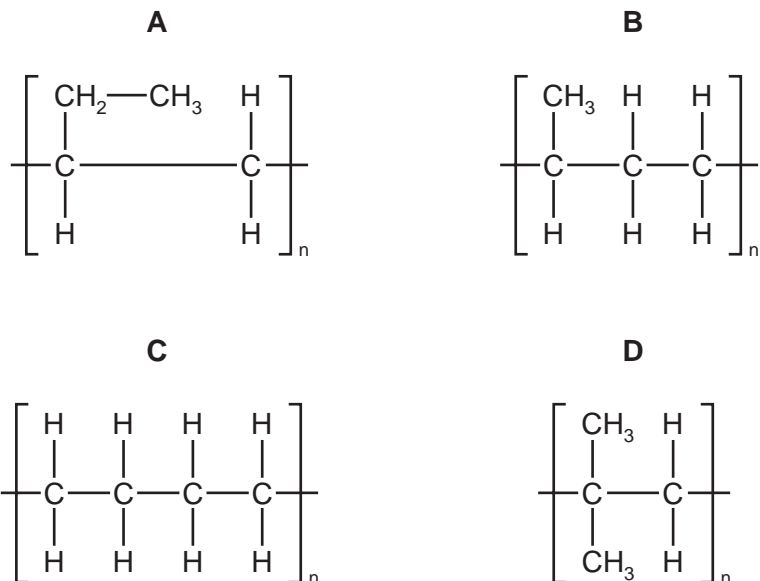

39 Glucose is a simple sugar. Glycine is an amino acid.

In the diagram, which two arrows correctly show the hydrolysis products of a carbohydrate and of a protein?

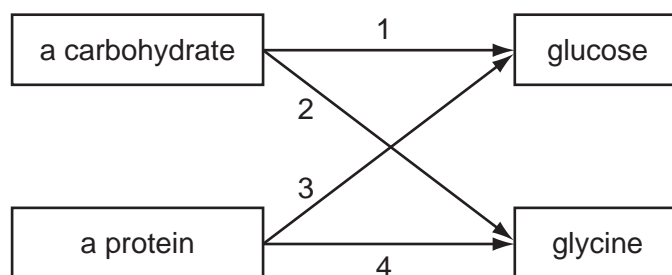

**A** 1 and 3      **B** 1 and 4      **C** 2 and 3      **D** 2 and 4

40 When crude oil is distilled several products are obtained.

What is the correct order of their boiling points?

	highest boiling point <span style="margin-left: 100px;">→</span> lowest boiling point			
<b>A</b>	diesel	paraffin (kerosene)	petrol (gasoline)	lubricating oil
<b>B</b>	lubricating oil	diesel	paraffin (kerosene)	petrol (gasoline)
<b>C</b>	paraffin (kerosene)	petrol (gasoline)	lubricating oil	diesel
<b>D</b>	petrol (gasoline)	paraffin (kerosene)	diesel	lubricating oil







