



UNIVERSITY OF CAMBRIDGE INTERNATIONAL EXAMINATIONS
General Certificate of Education Ordinary Level

BIOLOGY

5090/01

Paper 1 Multiple Choice

May/June 2008

1 hour

Additional Materials: Multiple Choice Answer Sheet
Soft clean eraser
Soft pencil (type B or HB is recommended)



READ THESE INSTRUCTIONS FIRST

Write in soft pencil.

Do not use staples, paper clips, highlighters, glue or correction fluid.

Write your name, Centre number and candidate number on the Answer Sheet in the spaces provided unless this has been done for you.

There are **forty** questions on this paper. Answer **all** questions. For each question there are four possible answers **A, B, C** and **D**.

Choose the **one** you consider correct and record your choice in **soft pencil** on the separate Answer Sheet.

Read the instructions on the Answer Sheet very carefully.

Each correct answer will score one mark. A mark will not be deducted for a wrong answer.
Any rough working should be done in this booklet.

This document consists of **17** printed pages and **3** blank pages.



- 1 The diagram shows a typical plant cell after being placed in a concentrated salt solution for ten minutes.

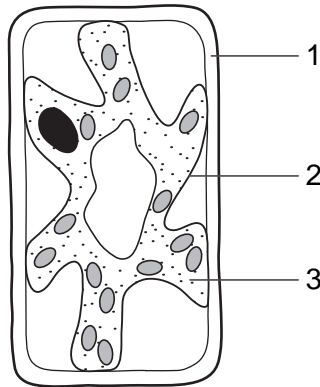

Which numbered structures are partially permeable?

- A** 1 and 2 only **B** 1 and 3 only **C** 1 only **D** 2 only
- 2 The small intestine of a person contains a low concentration of glucose produced from the digestion of starch.

Glucose is taken up by the cells of the villi.

How does the glucose move?

- A** by active transport against the concentration gradient
B by active transport with the concentration gradient
C by diffusion against the concentration gradient
D by diffusion with the concentration gradient

- 3 In an experiment to investigate the **effects of heat** on germinating barley grains, three petri dishes were set up as shown in diagram 1 and left for 3 days. A solution of iodine in potassium iodide was then added to the starch-agar substrate. The results are shown in diagram 2, in which the shaded areas went blue/black, indicating the presence of starch.

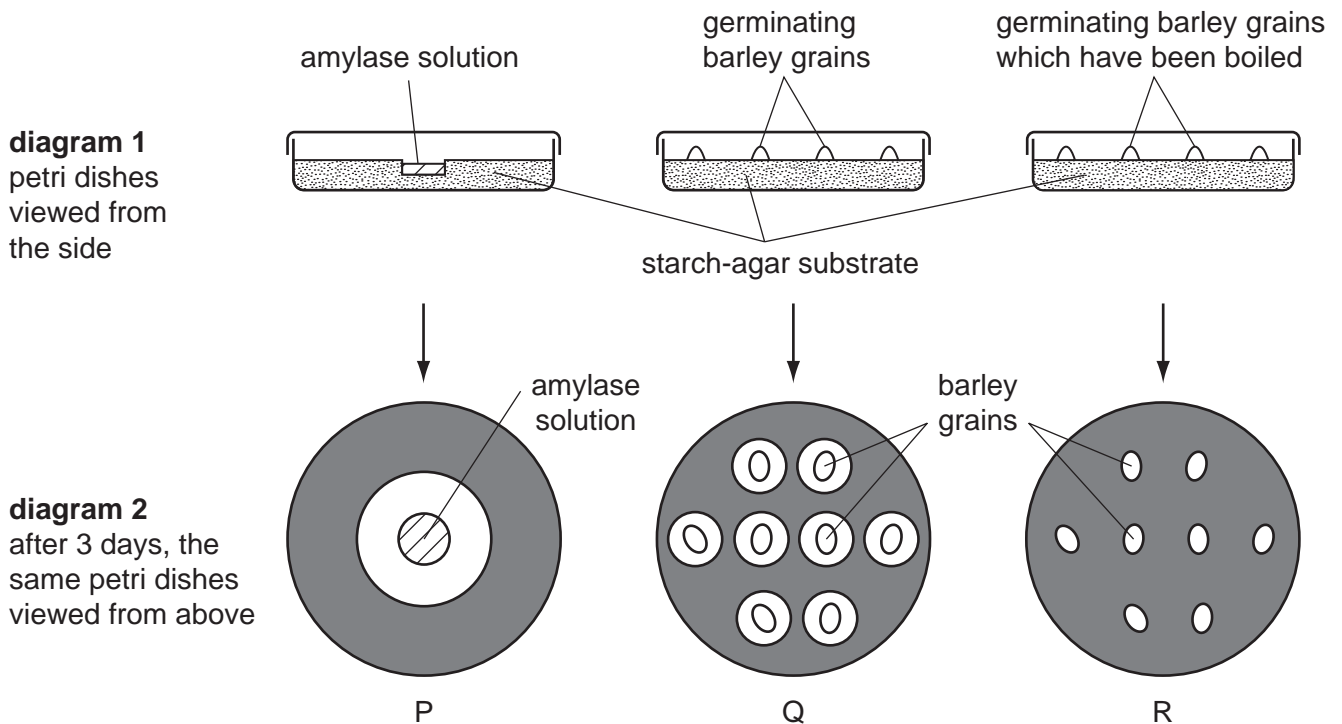

Which is the **best** explanation of the results?

- A Amylase is produced by barley grains that have been boiled.
 - B Amylase from barley grains is denatured when they are boiled.
 - C Germinating grains prevent iodine from staining starch blue/black.
 - D Starch from the substrate is used by the grains as an energy source.
- 4 Enzyme action can be explained by the lock and key hypothesis.

Where is the active site and which acts as the lock or key?

	active site	lock/ key
A	on the enzyme	substrate acts as a key
B	on the enzyme	substrate acts as a lock
C	on the substrate	enzyme acts as a key
D	on the substrate	enzyme acts as a lock

5 Where and how does carbon dioxide enter a plant?

	where	how
A	root hair cells	active uptake
B	root hair cells	diffusion
C	stomata	active uptake
D	stomata	diffusion

6 Four tubes, **A**, **B**, **C** and **D** are left in sunlight for one hour. The bicarbonate indicator solution in each tube is red at the start of the experiment.

Bicarbonate indicator solution stays red if there is no change in carbon dioxide concentration. The indicator goes yellow if carbon dioxide concentration increases and purple if the carbon dioxide concentration decreases.

In which tube does the colour change to purple?

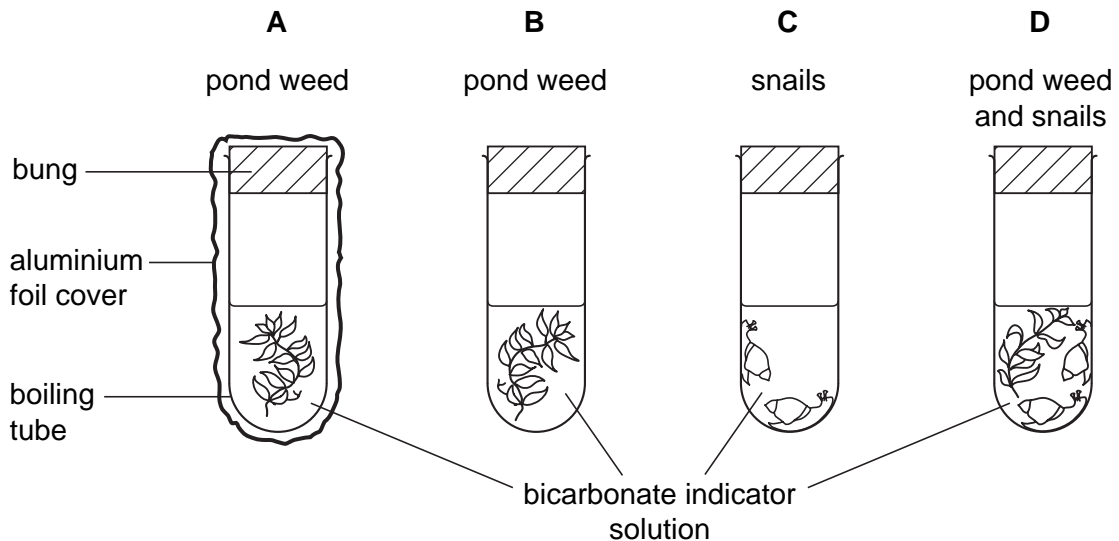

7 The graph shows the amount of oxygen produced by a green plant during a 24-hour period.

Which letter represents midnight?

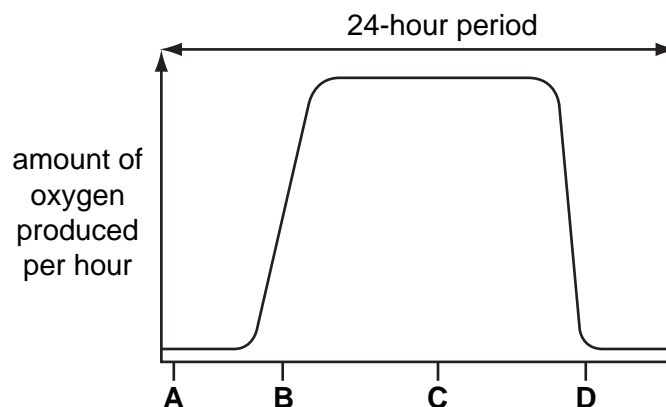

- 8 What is produced as a result of digestion by a protease?
- A amino acids
 - B fatty acids
 - C glucose
 - D glycerol
- 9 For which food test must the sample be dissolved in ethanol?
- A fat
 - B protein
 - C reducing sugar
 - D starch
- 10 An experiment was set up to investigate the effect of an enzyme on coagulated egg albumen. The results, after three hours, are shown in the diagram.

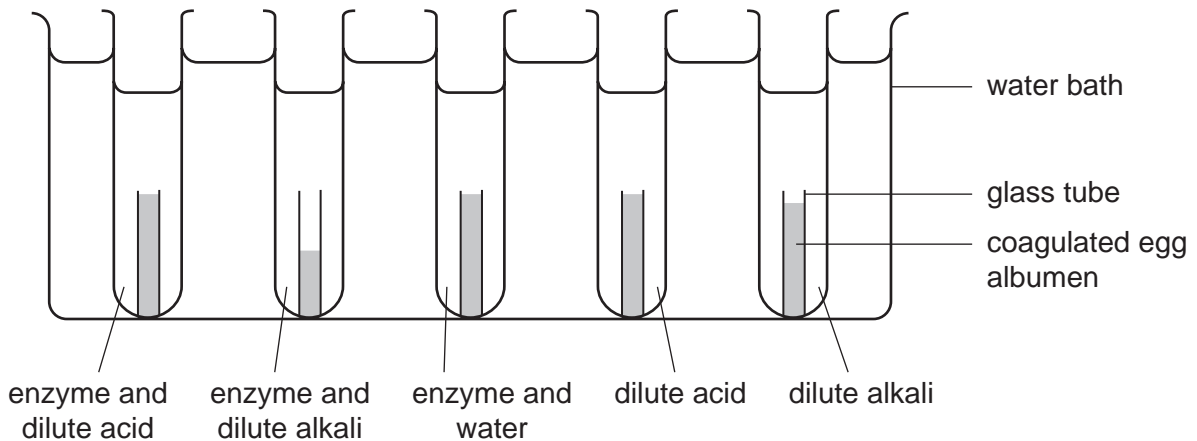

Where in the digestive system is the enzyme produced?

- A liver
 - B pancreas
 - C salivary glands
 - D stomach wall
- 11 When a complete ring of bark is removed from the trunk of a tree, it will eventually die because this action cuts off the supply of
- A mineral salts to the leaves.
 - B nutrients to the roots.
 - C oxygen to the roots.
 - D water to the leaves.

12 The diagram shows a transverse section from the middle of a root of a dicotyledonous plant.

In which tissue are sugars and amino acids transported?

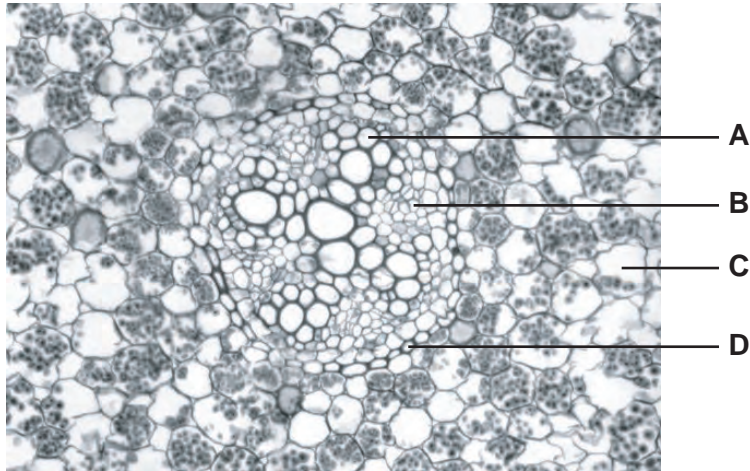

13 The diagram represents part of the human circulatory system.

Where is the blood pressure highest?

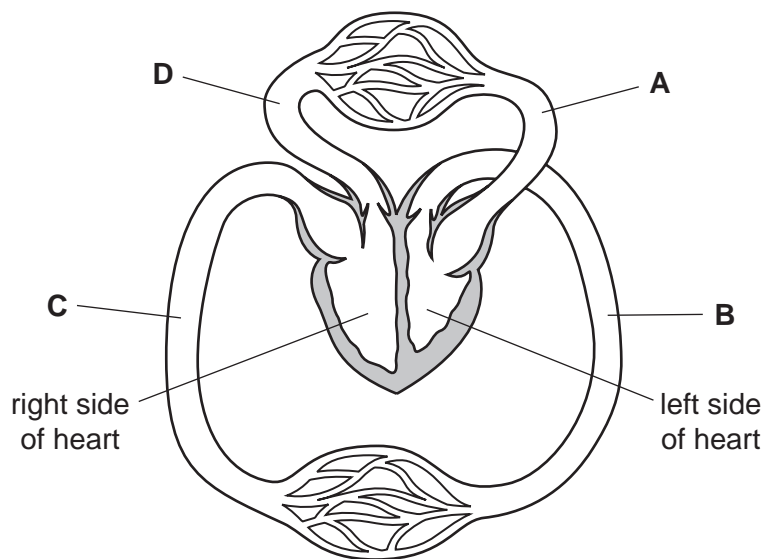

- 14 The graph shows pressure changes in the left ventricle and the left atrium (auricle) in one cycle of contraction of the heart.

During which period of time is the ventricle contracting?

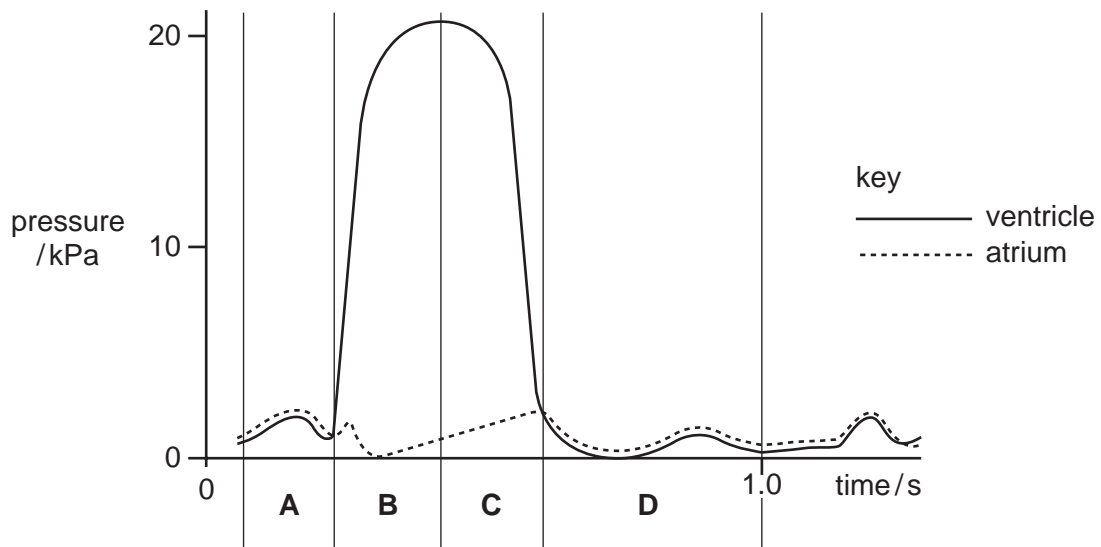

- 15 In the human body, blood circulating from the gut to the heart passes through the

- A aorta.
- B kidneys.
- C liver.
- D lungs.

16 An experiment is set up as shown.

Flasks 1 and 2 contain lime water. Air is pumped through the flasks.

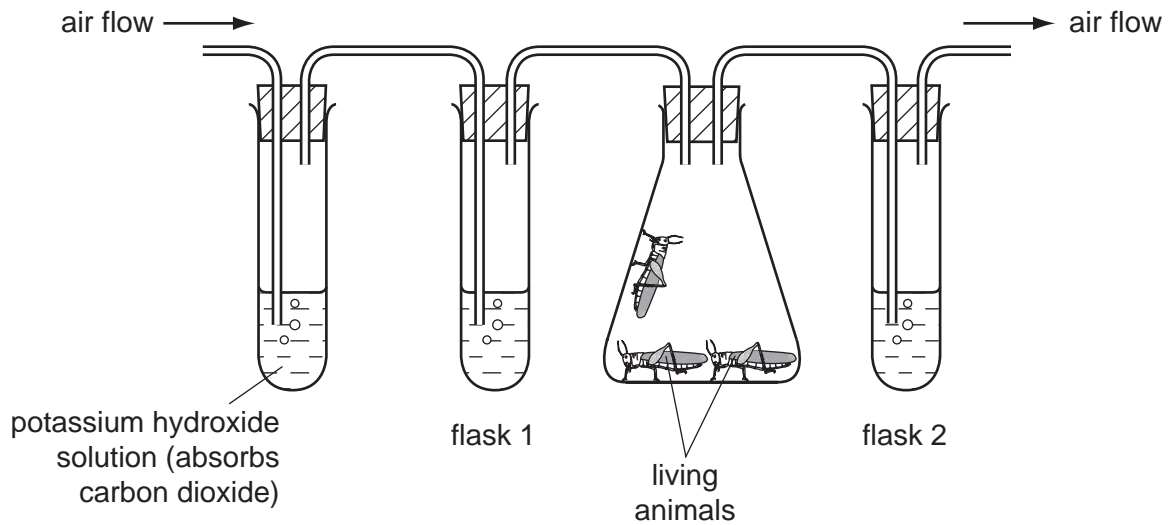

What is the appearance of limewater in flasks 1 and 2 after a period of ten minutes?

	flask 1	flask 2
A	clear	clear
B	clear	white / cloudy
C	white / cloudy	clear
D	white / cloudy	white / cloudy

17 The composition of inhaled air and exhaled air is different.

Which analysis is correct?

	inhaled air	exhaled air
A	more carbon dioxide	less oxygen
B	less oxygen	less carbon dioxide
C	more oxygen	more carbon dioxide
D	less carbon dioxide	more oxygen

18 Which does **not** produce carbon dioxide?

- A** a muscle fibre
- B** a sensory neuron
- C** blood
- D** saliva

19 The diagram shows the main muscles and bones of the arm.

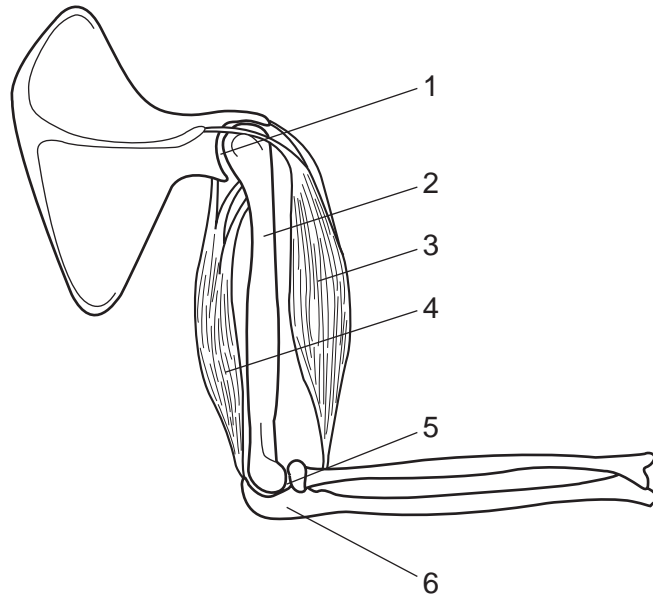

Which lines correctly identify the biceps muscle, the humerus and a hinge joint?

	biceps	humerus	hinge joint
A	3	6	1
B	4	2	5
C	3	2	5
D	4	6	1

20 The diagram represents a kidney dialysis machine.

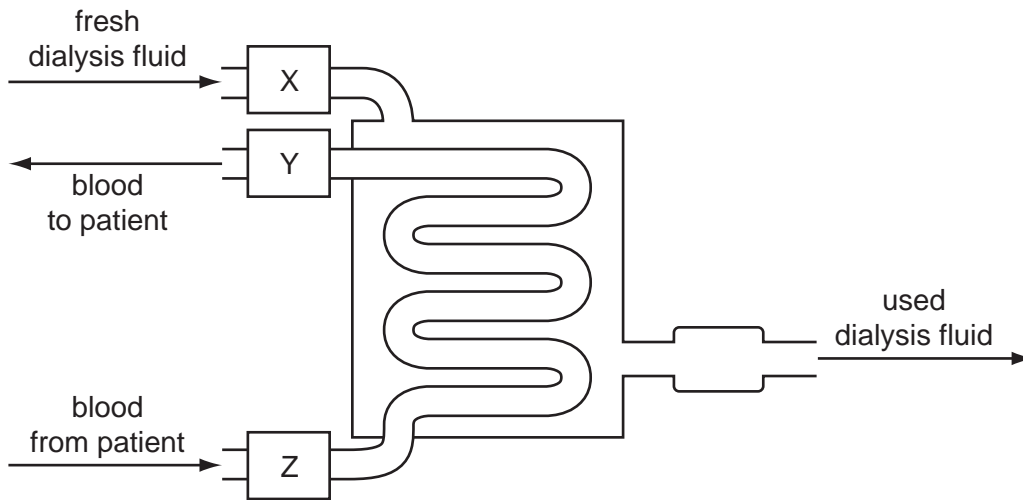

What are the parts labelled X, Y and Z?

	bubble trap	roller pump	water bath for temperature control
A	X	Y	Z
B	Y	Z	X
C	Y	X	Z
D	Z	Y	X

21 When a person is cold, nerve impulses from the hypothalamus cause the skin to reduce the rate of heat loss.

What is the effect of these nerve impulses on the hair erector muscles and on the arterioles near the skin surface?

	hair erector muscles	arterioles near skin surface
A	contract	contract
B	contract	relax
C	relax	contract
D	relax	relax

22 Adrenaline is secreted quickly when a person is frightened.

How does this affect the heart beat and the liver?

	heart beat	liver converts
A	decreases	glycogen to glucose
B	decreases	glucose to glycogen
C	increases	glycogen to glucose
D	increases	glucose to glycogen

23 Which part of the nervous system is the centre for processes such as thought, memory and judgement?

- A** cerebellum
- B** cerebrum
- C** medulla
- D** spinal cord

24 The graph shows changes in a person's blood glucose concentration over four hours.

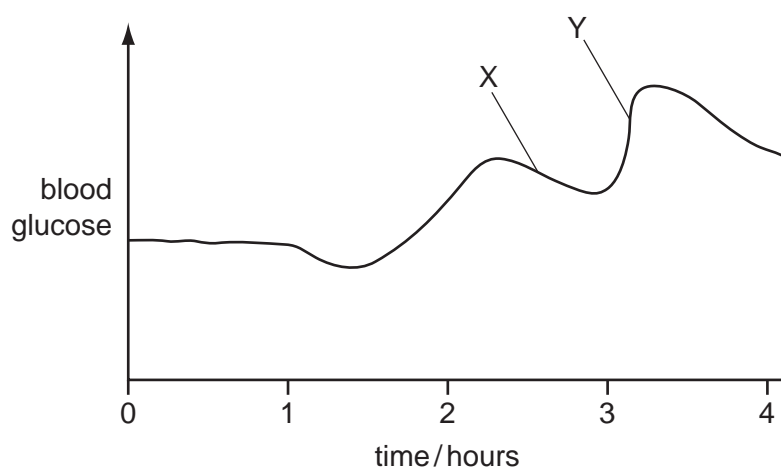

What might cause the changes at X and Y?

	X	Y
A	decreased insulin	decreased adrenaline
B	decreased insulin	increased adrenaline
C	increased adrenaline	increased insulin
D	increased insulin	increased adrenaline

25 The table shows the death rates from lung cancer amongst smokers and non-smokers.

average number of cigarettes smoked per day	deaths from lung cancer per year per 100 000 people
0	10
1-14	78
15-25	127
26 or more	251

What can be concluded from the data?

- A People who get lung cancer are likely to be smokers of 26 or more cigarettes per day.
- B People who do not smoke will not get lung cancer.
- C People who smoke have a higher chance of getting lung cancer.
- D Smoking causes lung cancer.

26 What is the role of the bacteria used in cheese and yoghurt production?

- A to coagulate casein to form 'curds'
- B to convert lactose to lactic acid
- C to prevent the growth of pathogens
- D to produce enzymes

27 The diagram shows a fermenter used for the production of antibiotics.

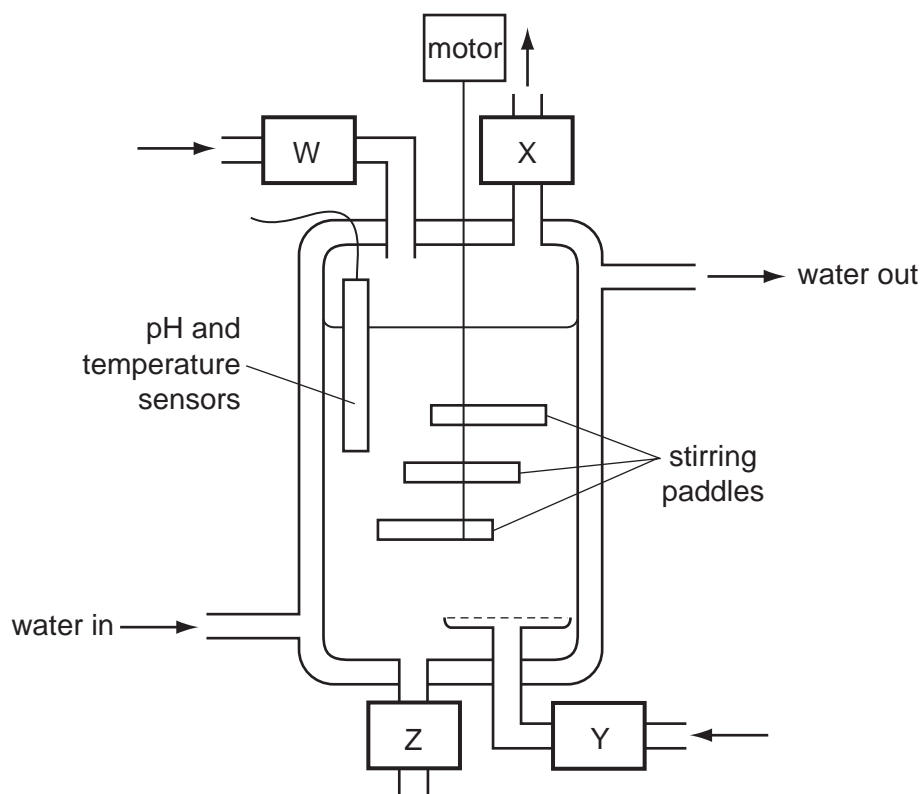

What happens at W, X, Y and Z?

	air in	antibiotic out	nutrients in	waste gases out
A	W	X	Y	Z
B	W	Y	Z	X
C	Y	Z	W	X
D	Z	W	X	Z

28 A decrease in the numbers of producers in a food chain will cause

- A** the consumers to increase in numbers.
- B** more animals to migrate into the area.
- C** the total productivity to increase.
- D** the total biomass to decrease.

29 The diagram shows a food web from an ecosystem.

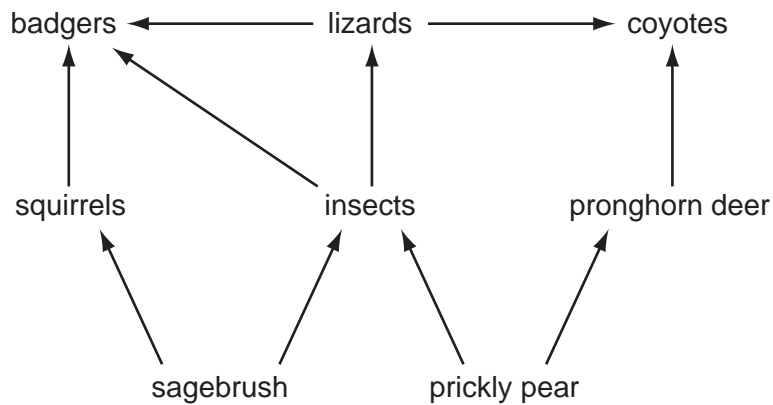

If the population of insects decreases, which other population will decrease the most?

- A badgers
- B lizards
- C sagebrush
- D squirrels

30 The diagram shows part of the carbon cycle.

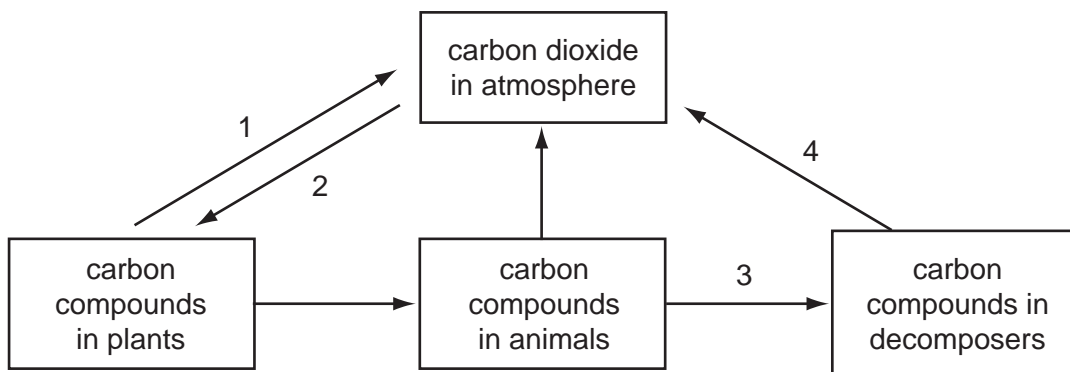

Which numbered arrows represent respiration?

- A 1 and 3
- B 1 and 4
- C 2 and 3
- D 2 and 4

31 Which term describes the role of the mosquito in the transmission of malaria?

- A parasite
- B pathogen
- C pest
- D vector

32 Cutting down large areas of tropical forest can lead to a reduction in rainfall.

What is the reason for the reduction in rainfall?

- A a reduction in photosynthesis
- B a reduction in transpiration
- C an increase in flooding
- D an increase in respiration

33 New plants may be grown from groups of cells that are taken from other plants.

The diagram shows part of plant X.

From which structure will cell samples grow into new plants that are genetically identical to plant X?

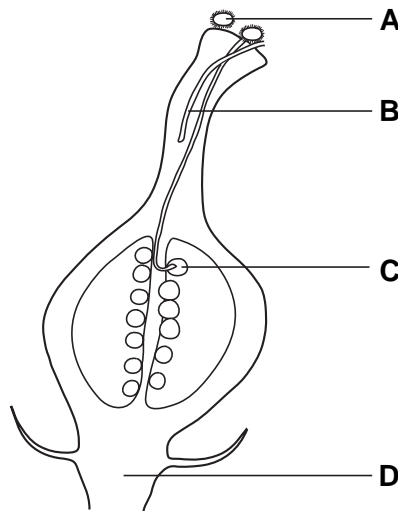

34 In plant reproduction, the following processes occur.

- 1 fertilisation
- 2 growth of a pollen tube
- 3 pollination
- 4 seed germination

In which order do these processes take place?

- A 1 → 4 → 2 → 3
- B 2 → 1 → 3 → 4
- C 3 → 2 → 1 → 4
- D 4 → 3 → 1 → 2

35 The diagram shows the female reproductive system.

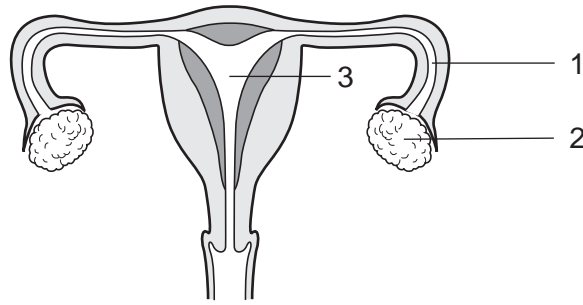

In which parts are the eggs and the zygote formed?

	eggs	zygote
A	1	2
B	1	3
C	2	1
D	2	3

36 The diagram shows the male reproductive and urinary systems.

Which structure produces the fluid part of semen?

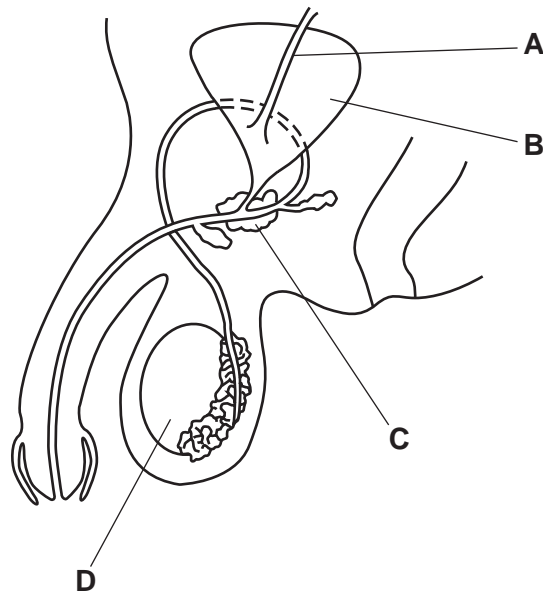

37 What causes sickle cell anaemia?

- A** a change in the structure of a gene
- B** an iron-deficient diet
- C** infection following a bite from a mosquito
- D** loss of blood following an accident

38 The diagram shows the inheritance of coat colour in mice.

Which mouse is heterozygous for coat colour?

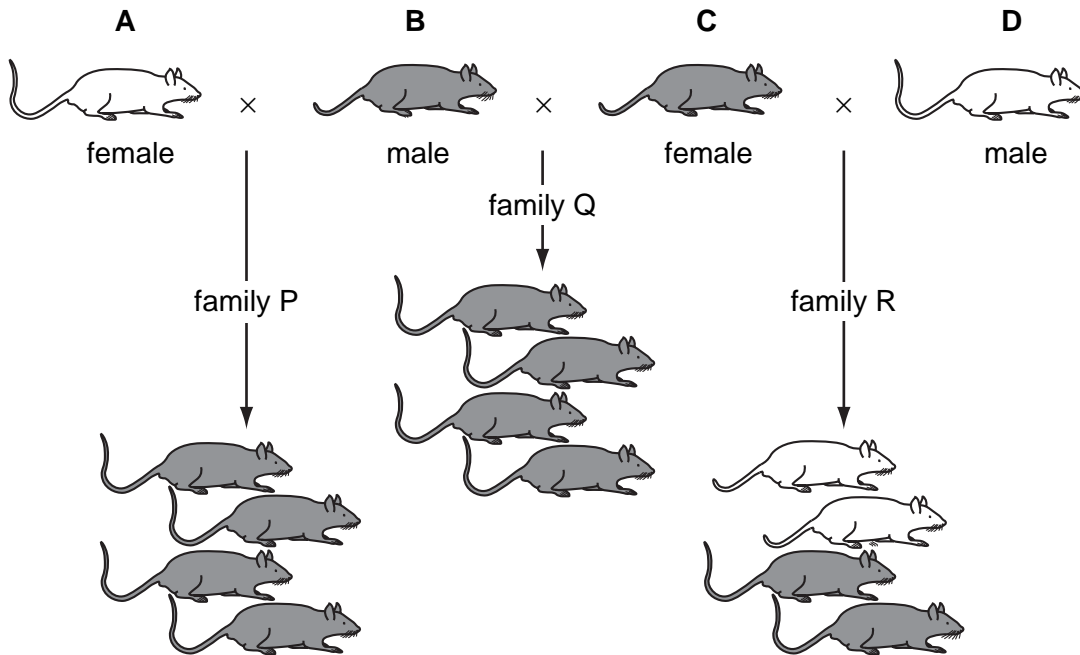

39 Two fruit flies with normal wings were mated with each other.

For every three offspring with normal wings, there is one with short wings.

What are the genotypes of the parents?

	female	male	
A	Nn	Nn	key N = allele for normal wings n = allele for short wings
B	Nn	NN	
C	NN	Nn	
D	Nn	nn	

40 What is a result of natural selection?

- A cattle that produce large quantities of milk
- B crop plants that are resistant to disease
- C grapes that develop no seeds
- D mosquitoes that are resistant to insecticides

BLANK PAGE

Permission to reproduce items where third-party owned material protected by copyright is included has been sought and cleared where possible. Every reasonable effort has been made by the publisher (UCLES) to trace copyright holders, but if any items requiring clearance have unwittingly been included, the publisher will be pleased to make amends at the earliest possible opportunity.

University of Cambridge International Examinations is part of the Cambridge Assessment Group. Cambridge Assessment is the brand name of University of Cambridge Local Examinations Syndicate (UCLES), which is itself a department of the University of Cambridge.