



UNIVERSITY OF CAMBRIDGE INTERNATIONAL EXAMINATIONS
International General Certificate of Secondary Education

TWENTY FIRST CENTURY SCIENCE (CORE)

0608/01

Paper 1 Multiple Choice

October/November 2012

1 hour

Additional Materials: Multiple Choice Answer Sheet
 Soft clean eraser
 Soft pencil (type B or HB is recommended)



READ THESE INSTRUCTIONS FIRST

Write in soft pencil.

Do not use staples, paper clips, highlighters, glue or correction fluid.

Write your name, Centre number and candidate number on the Answer Sheet in the spaces provided unless this has been done for you.

There are **forty** questions on this paper. Answer **all** questions. For each question there are four possible answers **A, B, C** and **D**.

Choose the **one** you consider correct and record your choice in **soft pencil** on the separate Answer Sheet.

Read the instructions on the Answer Sheet very carefully.

Each correct answer will score one mark. A mark will not be deducted for a wrong answer.

Any rough working should be done in this booklet.

You may use a calculator.

This document consists of **14** printed pages and **2** blank pages.



1 Which statement best describes the job carried out by genes?

- A Genes are instructions to make carbohydrates.
- B Genes are instructions to make proteins.
- C Genes remove waste products from cells.
- D Genes speed up the rate of chemical reactions.

2 Which set of chromosomes should be used to correctly complete the genetic diagram?

	X	Y
X	XX	XY
X	XX	

- A XY B XX C YY D XXXY

3 Which of the following questions cannot be addressed using a scientific approach?

- A What are the risks of inheriting a genetic disease?
- B Is it morally right to carry out genetic testing?
- C How does gene therapy work?
- D What conditions are required for pregnancy to happen?

4 Which of the following is a symptom of sickle cell anaemia?

- A chesty cough
- B difficulty digesting food
- C producing thick mucus
- D pains in joints

5 Which statement about clones is true?

- A A clone has different genes from its parent.
- B Clones can be produced by asexual reproduction.
- C Environmental factors cannot cause differences between clones.
- D Two clones have different genes.

- 6 A scientist measures the concentration of sulfur dioxide in the air near a power station.

The table shows his results.

sample	1	2	3	4	5	6	7
concentration of sulfur dioxide in $\mu\text{g}/\text{m}^3$	610	598	604	623	355	630	595

Which statement about the results is correct?

- A** It is not possible to calculate a best estimate from these results.
- B** The mean of the results is $355 \mu\text{g}/\text{m}^3$.
- C** The range of results is between 610 and $595 \mu\text{g}/\text{m}^3$.
- D** There is an outlier in the results.
- 7 Sulfur dioxide reacts with other gases in the air to form acid rain.

Which gases does sulfur dioxide react with to form acid rain?

- A** carbon dioxide and water vapour
- B** nitrogen oxides
- C** oxygen and nitrogen
- D** water vapour and oxygen
- 8 Scientists compare the gases from active volcanoes with our atmosphere today.

The table shows the gases from an active volcano.

gas	percentage composition
water vapour	77 %
carbon dioxide	11 %
sulfur dioxide	8 %

Which statement is a correct comparison?

- A** The main gas in both the volcano gases and in our atmosphere today is water vapour.
- B** There is less sulfur dioxide in the volcano gases than in our atmosphere today.
- C** There is more carbon dioxide in the volcano gases than in our atmosphere today.
- D** Our atmosphere today is the same as the gases from a volcano.

9 Natural processes take carbon dioxide out of the air.

Which process does **not** remove carbon dioxide from the air?

- A respiration by animals
- B dissolving in rain water
- C forming a solution in sea water
- D photosynthesis by plants

10 The map shows the Earth's tectonic plates.

At which letter is an earthquake **most** likely to happen?

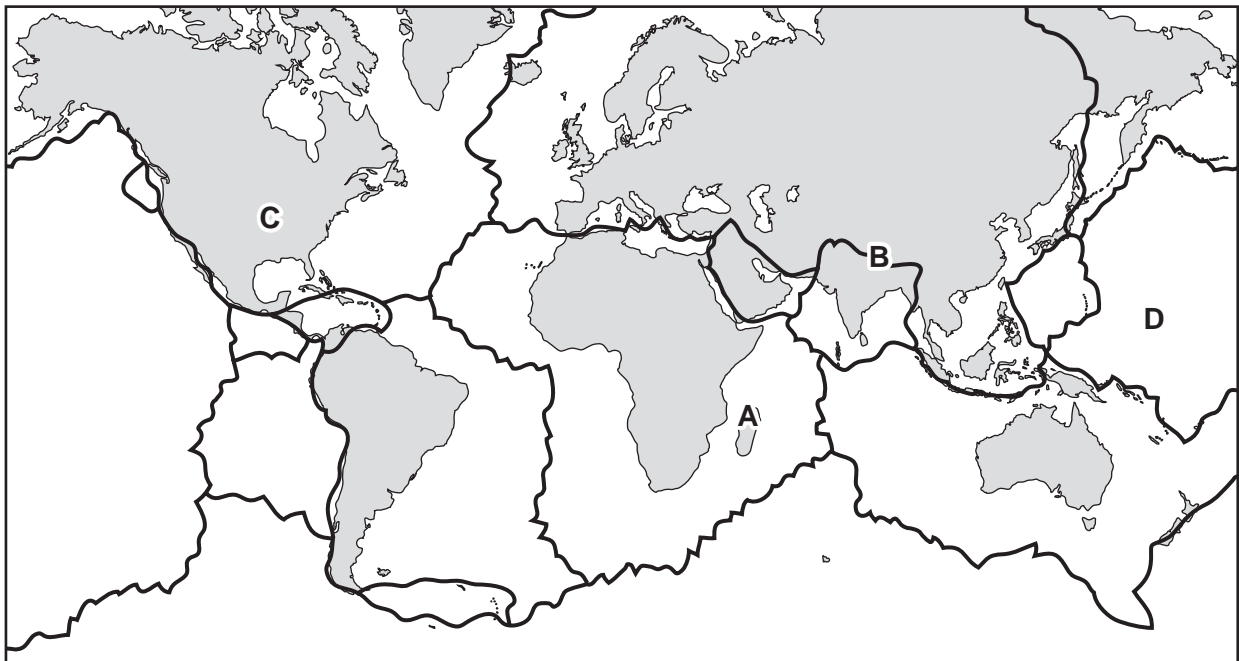

11 Which piece of evidence was **not** available to Wegener to support his theory of continental drift?

- A the existence of mountains
- B the geometric fit of continents
- C the matching of fossils along coasts of continents
- D the speed of movement of the continents

12 The diagram shows the structure of the Earth.

Which is the crust?

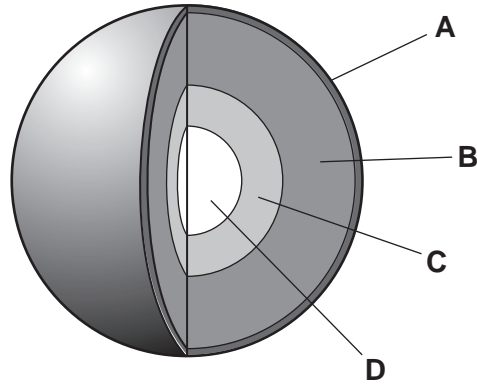

13 How did the Sun form?

- A from an exploding asteroid
- B from a cloud of dust and gas
- C from a collision between planets
- D from a collision between continents

14 Where in the solar system is life found?

- A Earth and Mars
- B Earth only
- C Mars only
- D Venus and Earth

15 The more cigarettes you smoke, the more likely you are to suffer from lung cancer.

This is called a correlation.

Which of the following is the **outcome** in this correlation?

- A both smoking and having lung cancer
- B having lung cancer
- C stopping smoking
- D smoking

16 Vaccines can never be completely safe.

Which statement best explains why?

- A Different individuals have different side-effects from a vaccine.
- B Mistakes are often made in the production of the vaccine.
- C Vaccines are dangerous chemicals.
- D Vaccines contain active microorganisms.

17 Against which group of microorganisms are antibiotics effective?

- A bacteria and fungi only
- B fungi and viruses only
- C viruses and bacteria only
- D bacteria, fungi and viruses

18 The pie chart shows the percentage of different types of animals that are used in testing drugs.

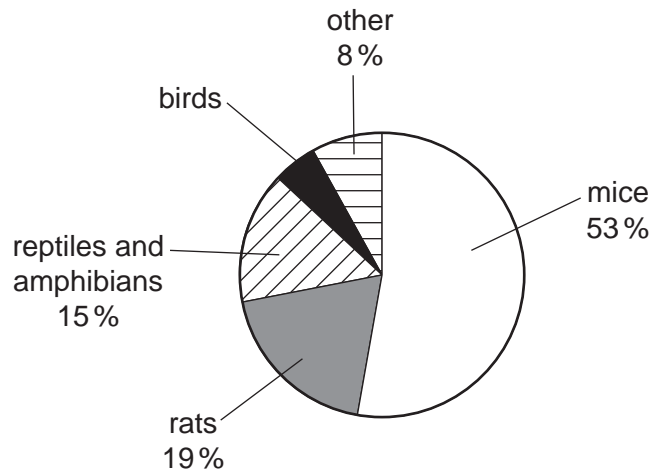

Which percentage of tests use birds?

- A 2%
- B 5%
- C 13%
- D 95%

19 What is the correct order for testing new drugs for safety and effectiveness?

- A healthy volunteers → ill patients → human cells
- B human cells → healthy volunteers → ill patients
- C human cells → ill patients → healthy volunteers
- D ill patients → human cells → healthy volunteers

20 Which statement about heart muscle cells and their blood supply is correct?

- A Heart muscle cells do **not** need their own blood supply because the heart is full of blood.
- B Heart muscle cells need their own blood supply to provide each cell with carbon dioxide.
- C Heart muscle cells do **not** need their own blood supply because the heart rests between beats.
- D Heart muscle cells need their own blood supply to provide each cell with glucose and oxygen.

21 Silk is a natural fibre.

Joe tested some silk threads to find out how much they stretched when a weight was hung from them.

Each piece of silk thread was the same length and thickness and the same weight was used each time.

His results are shown in the table.

test	1	2	3	4
length thread stretched in cm	2	5	1	8

Why do the results show such a large difference between them?

- A All the results are outliers.
- B Joe should have used shorter pieces of thread.
- C The silk thread is too stretchy.
- D The stretchiness of the threads varies.

22 A polymer is modified to increase its melting point.

Which polymer shown below would have the lowest melting point?

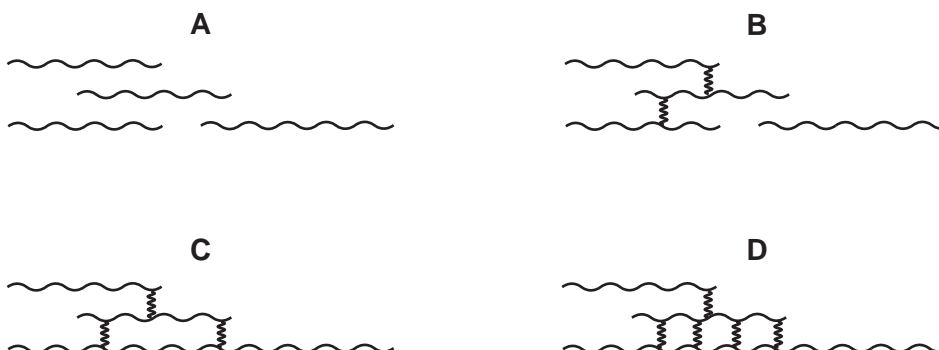

23 Which factor is **not** a key feature of a life cycle assessment for a product?

- A environmental impact of disposing of the product
- B environmental impact of using the product
- C production costs
- D requirement for energy input

24 Some packaging for fast food is made from cardboard and some is made from polystyrene.

Read the following statements.

- 1 Polystyrene is made from crude oil; cardboard is made from plant material.
- 2 Polystyrene packaging is more hardwearing than cardboard packaging.
- 3 Both types of packaging can be recycled into other products.
- 4 Polystyrene is non-biodegradable; cardboard rots away.
- 5 Polystyrene packaging is lighter to transport than cardboard packaging.

Which of the statements are about the sustainability of **making** packaging?

- A 1 only
- B 1 and 4 only
- C 1, 3, 4 and 5
- D 2 and 5

25 Crude oil is a mixture of hydrocarbons.

Which group of compounds does **not** contain a hydrocarbon?

- A C_6H_{14} , C_9H_{20} , C_4H_{10}
- B $C_6H_{13}OH$, $C_5H_{11}OH$, $C_{10}H_{21}OH$
- C C_5H_{12} , C_8H_{18} , $C_{10}H_{22}$
- D $C_5H_{11}OH$, C_8H_{18} , $C_{10}H_{21}OH$

26 When you watch a TV, light travels from the TV screen to your eye.

Which row best describes the process happening?

	TV screen	air	eye
A	absorbs	emits	reflects
B	absorbs	reflects	transmits
C	emits	transmits	absorbs
D	emits	absorbs	transmits

27 What are the 'packets' of energy in a beam of electromagnetic radiation called?

- A** particles
- B** photons
- C** product
- D** protons

28 Which feature of a microwave oven protects people from microwave radiation?

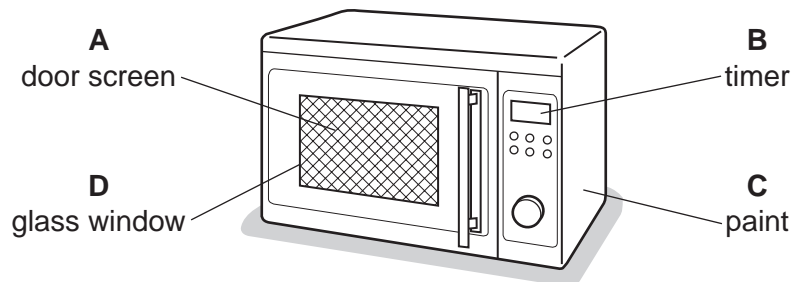

- 29 The two graphs show how the Earth's temperature and the concentration of carbon dioxide in the atmosphere have changed in the last 150 000 years.

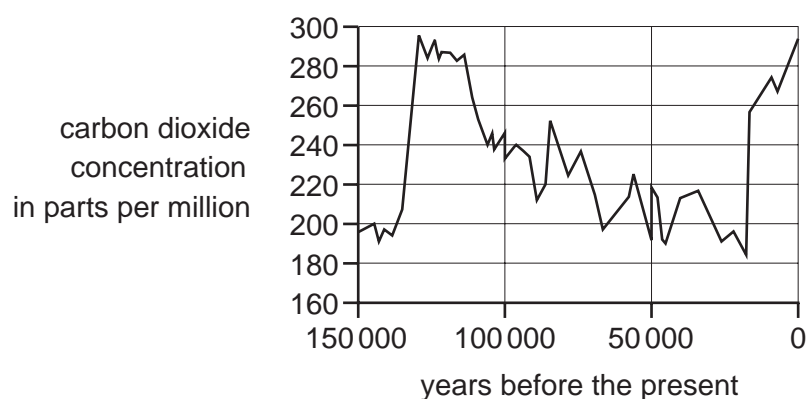
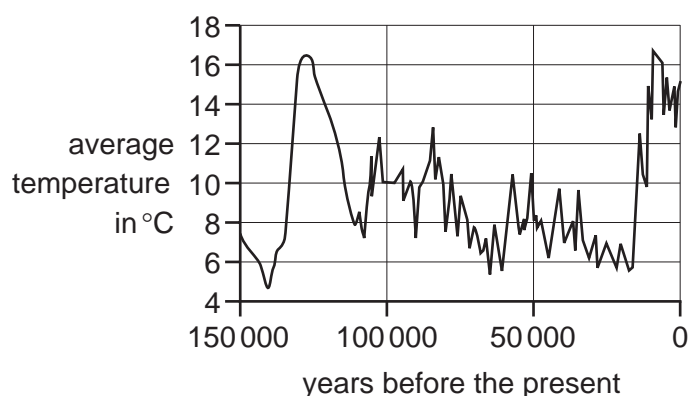

Which statement is a correct interpretation of this data?

- A** Increases in carbon dioxide concentration make the average temperature rise.
B Increases in the average temperature make the carbon dioxide concentration rise.
C There is no link between carbon dioxide concentration and average temperature.
D There is a correlation between carbon dioxide concentration and average temperature.
- 30 Which of the following provide evidence for evolution?

- 1 ancient texts
- 2 fossils
- 3 DNA
- 4 Darwin's theory

- A** 1 and 2 **B** 1 and 4 **C** 2 and 3 **D** 3 and 4

- 31 The central nervous system (CNS) consists of
- A sensors and receptors only.
 - B sensors, brain and receptors.
 - C sensors, spinal cord and receptors.
 - D the brain and spinal cord.
- 32 Some plants living in dry areas grow longer roots than other plants to reach deeper into the soil and find more water.

Which term best describes this?

- A competition
 - B evolution
 - C extinction
 - D predation
- 33 Four students explain the difference between natural selection and selective breeding.

Which student gives the best explanation?

A



Natural selection is natural and selective breeding is selective.

B



Natural selection involves evolution but selective breeding does not.

C



Natural selection occurs in nature but selective breeding involves humans selecting the characteristics they want.

D



Natural selection usually happens more quickly than selective breeding.

- 34 Why are emulsifiers and stabilisers added to food products?
- A to keep food safe for longer
 - B to mix ingredients together that would normally separate
 - C to prevent food from deteriorating by reacting with oxygen in the air
 - D to reduce the amount of sugar

The following information should be used for questions 35 and 36.

The table shows the average daily energy intake from food and energy output of four children.

	energy intake from food in kJ	energy output in kJ
Ally	8 000	7 500
Bee	4 000	7 000
Connor	10 000	4 000
David	8 000	8 200

35 Which child is most likely to be underweight?

- A Ally
- B Bee
- C Connor
- D David

36 Look at the information about Connor in the table.

Connor goes to see a doctor because he is worried about his general health.

What advice should the doctor give to Connor?

- A Connor needs to increase his daily energy intake from food.
- B Connor should drink more water.
- C Connor should be more active.
- D Connor should increase the amount of minerals in his diet.

- 37 The graph shows the radiation doses received by a person in one hour from four different sources.

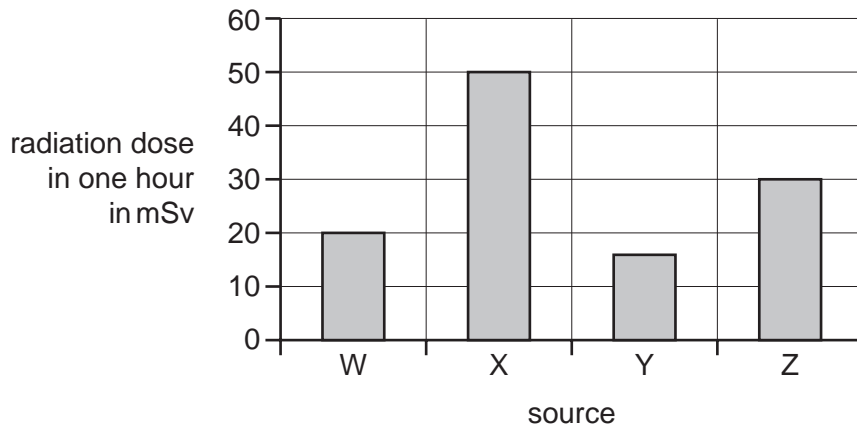

How many times more harmful is source Z than source W?

- A** 0.67 **B** 1.5 **C** 10 **D** 30
- 38 The graph shows the results of an experiment in which an increasing number of sheets of aluminium foil were placed between a radioactive source and a detector to investigate their effect on the count rate.

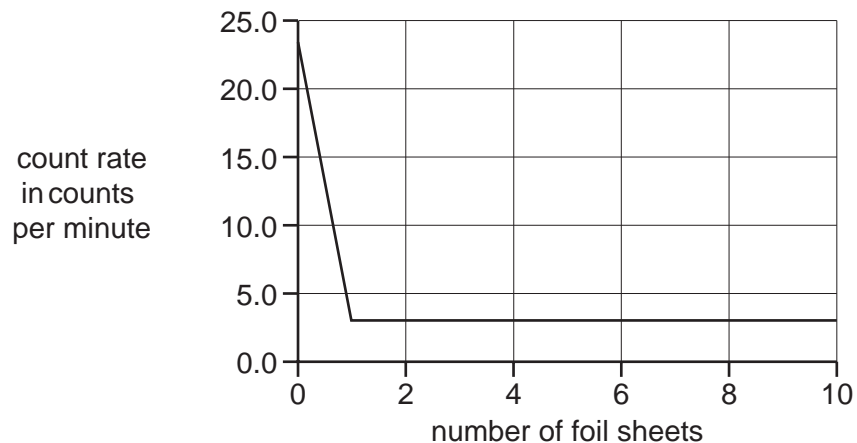

Which is the best conclusion for this experiment?

- A** One foil sheet reduces the count rate by 23 counts per minute.
B The background radiation is ten counts per minute.
C The source emits beta radiation only.
D The source emits gamma radiation only.

- 39** A new drug has been developed that helps reduce the side-effects of using radiation to treat cancers.

Who will decide when the drug is ready to be used on human patients?

- A** doctors who test the drug to see if it works
 - B** government officials who look at all the information about the drug
 - C** patients who will benefit from the drug
 - D** physicists who produce the radioactive sources
- 40** High level nuclear waste produced in a nuclear power station is dangerous to living things.

What is the best way to dispose of this waste?

- A** burying it in the soil near the power station
- B** dumping it in landfill in the same way as domestic waste
- C** pumping it far out to sea to dilute it
- D** cooling it and burying it in dry rock deep under ground

BLANK PAGE

Permission to reproduce items where third-party owned material protected by copyright is included has been sought and cleared where possible. Every reasonable effort has been made by the publisher (UCLES) to trace copyright holders, but if any items requiring clearance have unwittingly been included, the publisher will be pleased to make amends at the earliest possible opportunity.

University of Cambridge International Examinations is part of the Cambridge Assessment Group. Cambridge Assessment is the brand name of University of Cambridge Local Examinations Syndicate (UCLES), which is itself a department of the University of Cambridge.