



UNIVERSITY OF CAMBRIDGE INTERNATIONAL EXAMINATIONS
International General Certificate of Secondary Education

CANDIDATE
NAME

CENTRE
NUMBER

--	--	--	--	--

CANDIDATE
NUMBER

--	--	--	--	--

* 2 1 6 2 7 0 4 7 5 9 *

CO-ORDINATED SCIENCES

0654/51

Paper 5 Practical Test

May/June 2012

2 hours

Candidates answer on the Question Paper.

Additional Materials: As listed in Instructions to Supervisors

READ THESE INSTRUCTIONS FIRST

Write your Centre number, candidate number and name on all the work you hand in.

Write in dark blue or black pen.

You may use a pencil for any diagrams, graphs or rough working.

Do not use staples, paper clips, highlighters, glue or correction fluid.

DO NOT WRITE IN ANY BARCODES.

Answer **all** questions.

Chemistry practical notes for this paper are printed on page 16.

At the end of the examination, fasten all your work securely together.

The number of marks is given in brackets [] at the end of each question or part question.

For Examiner's Use	
1	
2	
3	
Total	

This document consists of **12** printed pages and **4** blank pages.



- 1 You are going to test the effect of light on the chemical composition of leaves. You are provided with two leaves from two separate plants of the same species.

Leaf **A** has been removed from a plant that has been in strong light for a period of 24 hours.

Leaf **B** has been removed from a plant that has been kept in the dark for 48 hours.

- Half fill a 250 cm³ beaker with water. Heat the water with a Bunsen burner until it is boiling.
- **Turn off the Bunsen burner.**
- Pick up leaf **A** with a pair of tweezers (forceps) and hold it in the hot water for 15 seconds.
- Using the tweezers place the leaf into the bottom of the large test-tube labelled **A**.
- Repeat the above procedure for leaf **B**, but place the leaf into the bottom of the large test-tube labelled **B**.
- Cover the leaves with alcohol and place the tubes **A** and **B**, into the beaker of hot water (water bath) for 5 minutes. The Bunsen burner must **not** be lit.
- Carefully remove both tubes from the water bath and pour off the alcohol into the waste beaker.

- (a) (i) Describe the colour of the alcohol that you have poured off from the tubes. Suggest what substance from the leaf has dissolved in the alcohol to produce the colour you have described.

colour

substance [2]

- (ii)
- Remove the leaves from the tubes with tweezers and hold them in the water bath for 2 to 3 seconds.
 - Place the leaves into the separate petri dishes (or onto the white tiles) labelled **A** and **B**. Use the tweezers to lay them flat and cover both leaves with iodine solution. Leave for about 2 minutes.
 - Wash off the excess iodine solution with cold water. Pour any excess liquid into the waste beaker.
 - Observe and record the colour of the leaves in Table 1.1.
 - The colour of each leaf suggests a substance that may be present or absent in it. Use your observation to make a conclusion about each leaf. Record your conclusion in Table 1.1.

Table 1.1

	leaf A	leaf B
colour of leaf after 2 minutes		
conclusion		

For
Examiner's
Use

[3]

(b) (i) Explain why leaves **A** and **B** were placed in boiling water before being placed in alcohol.

.....
..... [1]

(ii) Explain how light has caused the difference in colour, shown by the iodine test, between leaves **A** and **B**.

.....
.....
.....
..... [3]

- (c) In another experiment, three test-tubes are labelled **C**, **D** and **E**. In each test-tube there is 10 cm^3 of indicator. The contents of each test-tube, and the conditions to which they have been exposed, are shown in Fig. 1.1.

For
Examiner's
Use

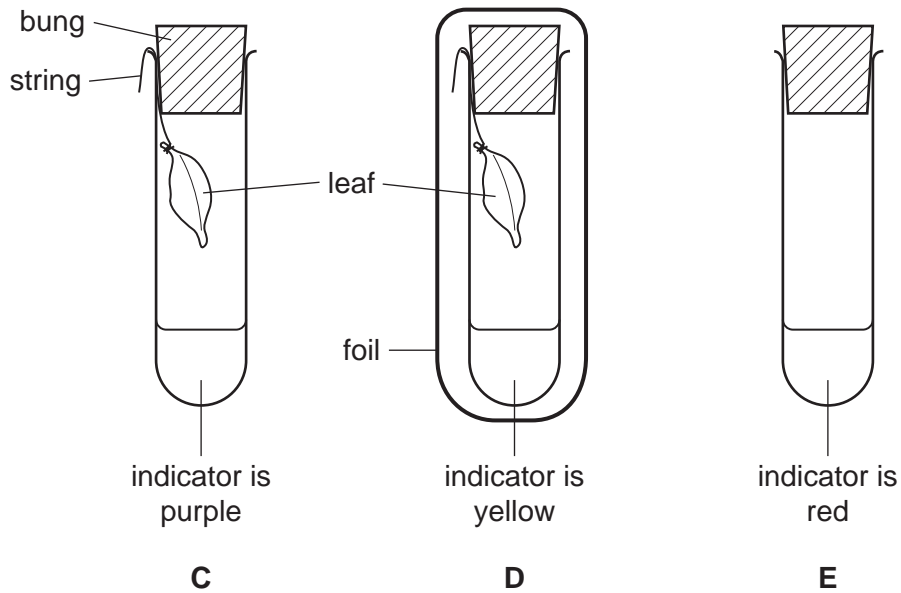

test-tube	C	D	E
indicator	10 cm^3	10 cm^3	10 cm^3
leaf	1 present	1 present	no leaf
light	full light for 24 hrs	covered in foil for 24 hrs	full light for 24 hrs
indicator colour	purple	yellow	red

Fig. 1.1

The indicator solution shows the changes in the levels of carbon dioxide gas in the atmosphere surrounding it.

- At normal atmospheric concentrations of carbon dioxide gas, the indicator solution is red.
- If atmospheric carbon dioxide concentrations falls, the indicator turns purple.
- If atmospheric carbon dioxide concentration rises, the indicator turns yellow.

(i) Suggest a reason for the bung in the top of each test-tube.

.....
..... [1]

(ii) Suggest a reason for carrying out the experiment in test-tube E.

.....
..... [1]

(iii) Explain the reasons for the colours of the indicator in

test-tube C,

.....

test-tube D.

..... [4]

- 2 (a) You are going to find the cross-sectional area of a piece of resistance wire using the apparatus in Fig. 2.1 and Fig. 2.2.

For
Examiner's
Use

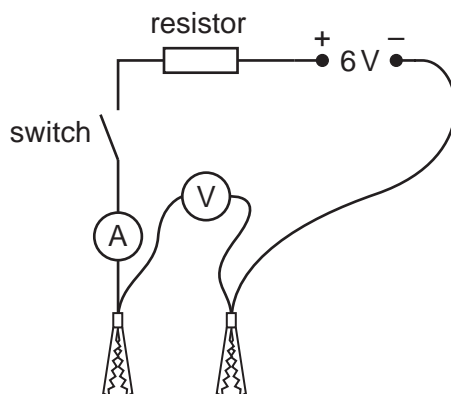

Fig. 2.1

- (i)
- Construct the circuit shown in Fig. 2.1. You will be connecting the crocodile clips to the resistance wire.
 - Connect one crocodile clip at the 0 cm point on the rule, with most of the length of the wire pointing along the rule. This will become the point **X** shown on Fig. 2.2.

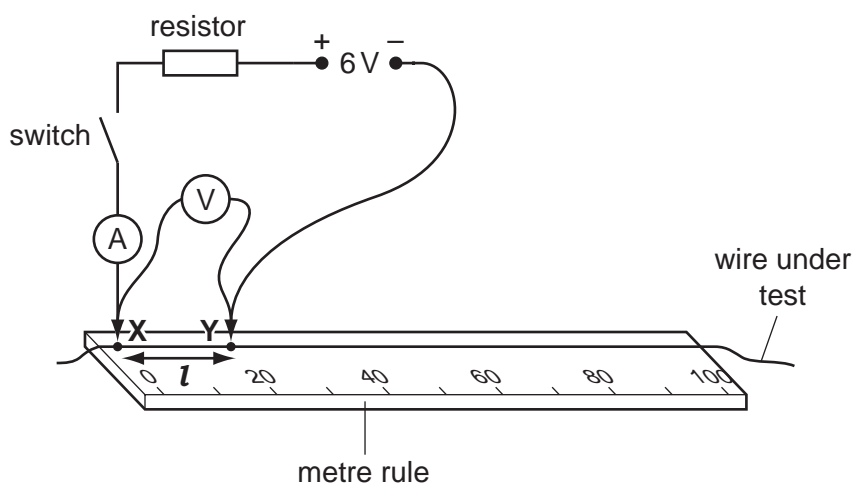

Fig. 2.2

- Complete the circuit by pressing the other crocodile clip firmly on to the resistance wire at point **Y** shown in Fig. 2.2. Make sure that the length, ***l***, between point **X** and point **Y** is 20 cm.
- Close the switch and read the current, ***I***, on the ammeter and the potential difference, ***V***, on the voltmeter. Record these readings in Table 2.1. [1]
- Open the switch.

Table 2.1

length of wire, l /cm	potential difference, V /volts	current, I /amps	resistance, R /ohms
20			
40			
60			
80			
100			

For
Examiner's
Use

- (ii) Repeat the procedure described in (i), adjusting point **Y** so that the length, l , is 40 cm. Close the switch and read the current, I , on the ammeter and the potential difference, V , on the voltmeter. Record these readings in Table 2.1. [1]

Open the switch.

- (iii) Repeat (i) for $l = 60$ cm, 80 cm and 100 cm. For each length, l , record the current, I , and the potential difference, V , in Table 2.1. [2]

Open the switch.

- (iv) Calculate the resistance, R , of each length of the resistance wire and enter the values in Table 2.1.

Use the formula below.

$$\text{resistance, } R = \frac{V}{I}$$

[1]

- (b) (i) Plot a graph of resistance, R , (vertical axis) against length of wire, l . Draw a straight line of best fit. Your line should pass through the origin, (0,0).

For
Examiner's
Use

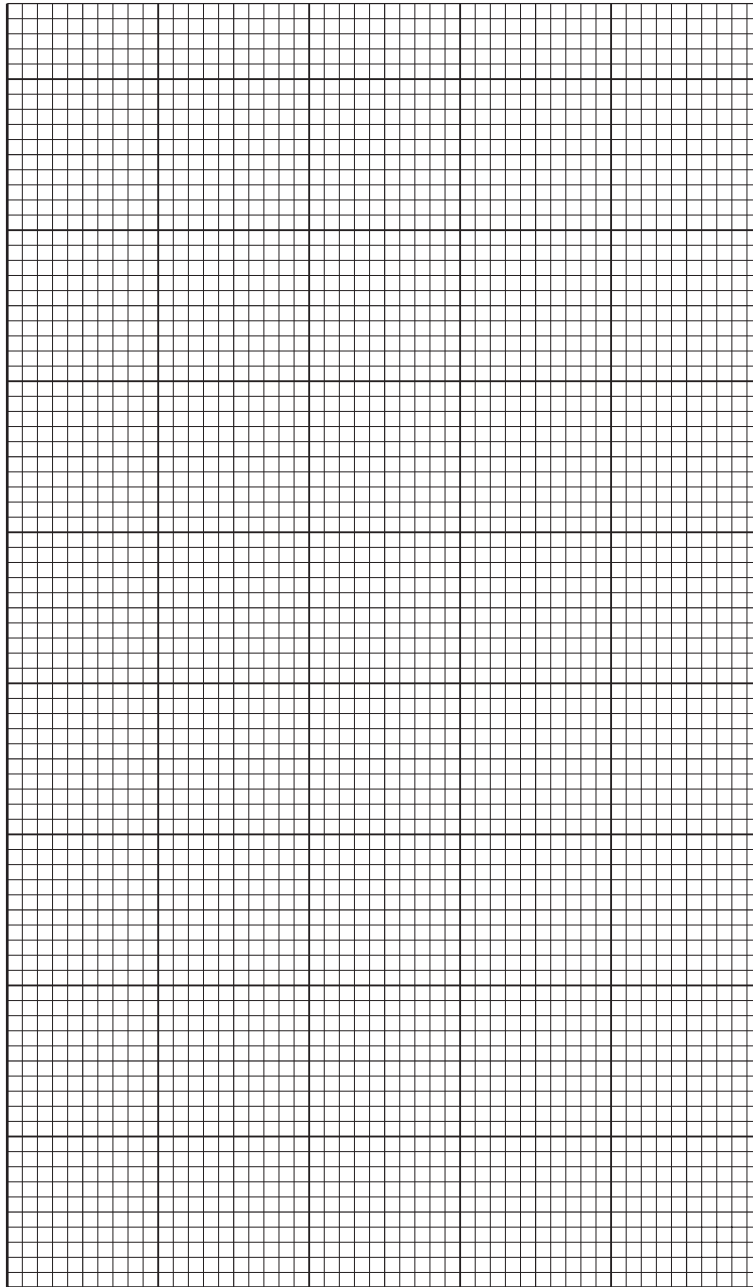

[4]

- (ii) Find the gradient of the line and show clearly your working either on the graph or below.

gradient = [2]

- (iii) Calculate the cross-sectional area, **C**, of the resistance wire using the formula given below.

$$C = \frac{0.000\ 049}{\text{gradient}}$$

C = cm² [1]

- (iv) Convert the cross-sectional area of the wire, **C**, from square centimetres, cm² to square metres, m².

..... m² [1]

- (c) Predict how the current, **I**, and the resistance, **R**, would change from the values in Table 2.1 if a resistance wire of the same material but greater cross-sectional area were to be used.

change in current, **I**

change in resistance, **R** [2]

For
Examiner's
Use

Please turn over for Question 3.

3 Solid mixture **A** contains two cations and two anions. Use the following tests to identify them.

For
Examiner's
Use

- (a) (i) • Place the mixture **A** in a 100 cm³ beaker and add about 30 cm³ of distilled or deionised water.
- Stir the mixture well.
 - Filter the mixture into the large test-tube for use in (b). Keep the residue in the filter paper for use in (a)(ii).
 - Describe the colour of the residue and the filtrate.

residue

filtrate [2]

- (ii) Scrape a little of the residue (about one-tenth) from (a)(i) into a clean test-tube. Slowly add dilute hydrochloric acid using a teat pipette (or dropper), 1 cm³ at a time, until it has all dissolved.

Record all your observations and make a conclusion about the anion present in the residue. Keep this solution for (a)(iii).

observations

.....

.....

conclusion

..... [3]

- (iii) To the solution from (a)(ii) add aqueous sodium hydroxide using a teat pipette, 1 cm³ at a time, until there is no further change.

Record your observations and conclusion about the cation in the residue from (a)(i).

observations

.....

conclusion

..... [2]

- (b) (i)** Place about 2 cm^3 of the filtrate from **(a)(i)** into a clean test-tube. Add 5 drops of aqueous silver nitrate.

Record your observations and conclusion.

observations

.....

conclusion

..... [2]

- (ii)** Place about 2 cm^3 of the filtrate from **(a)(i)** into a clean test-tube. Add about 1 cm^3 of aqueous barium chloride.

Record your observations and conclusion.

observations

.....

conclusion

..... [2]

- (iii)** Place about 2 cm^3 of the filtrate from **(a)(i)** into a clean hard glass test-tube. Add about 3 cm^3 aqueous sodium hydroxide. Carefully warm the test-tube and test any gases with damp red litmus paper.

Record your observations and conclusions and suggest a possible identity of the cation in the filtrate from **(a)(i)**.

observations

.....

.....

conclusion from litmus test

.....

possible identity of the cation from **(a)(i)**

..... [4]

CHEMISTRY PRACTICAL NOTES

Test for anions

<i>anion</i>	<i>test</i>	<i>test result</i>
carbonate (CO_3^{2-})	add dilute acid	effervescence, carbon dioxide produced
chloride (Cl^-) [in solution]	acidify with dilute nitric acid, then add aqueous silver nitrate	white ppt.
nitrate (NO_3^-) [in solution]	add aqueous sodium hydroxide then aluminium foil; warm carefully	ammonia produced
sulfate (SO_4^{2-}) [in solution]	acidify then add aqueous barium chloride <i>or</i> aqueous barium nitrate	white ppt.

Test for aqueous cations

<i>cation</i>	<i>effect of aqueous sodium hydroxide</i>	<i>effect of aqueous ammonia</i>
ammonium (NH_4^+)	ammonia produced on warming	-
copper(II) (Cu^{2+})	light blue ppt., insoluble in excess	light blue ppt., soluble in excess giving a dark blue solution
iron(II) (Fe^{2+})	green ppt., insoluble in excess	green ppt., insoluble in excess
iron(III) (Fe^{3+})	red-brown ppt., insoluble in excess	red-brown ppt., insoluble in excess
zinc (Zn^{2+})	white ppt., soluble in excess giving a colourless solution	white ppt., soluble in excess giving a colourless solution

Test for gases

<i>gas</i>	<i>test and test results</i>
ammonia (NH_3)	turns damp red litmus paper blue
carbon dioxide (CO_2)	turns limewater milky
chlorine (Cl_2)	bleaches damp litmus paper
hydrogen (H_2)	"pops" with a lighted splint
oxygen (O_2)	relights a glowing splint

Permission to reproduce items where third-party owned material protected by copyright is included has been sought and cleared where possible. Every reasonable effort has been made by the publisher (UCLES) to trace copyright holders, but if any items requiring clearance have unwittingly been included, the publisher will be pleased to make amends at the earliest possible opportunity.

University of Cambridge International Examinations is part of the Cambridge Assessment Group. Cambridge Assessment is the brand name of University of Cambridge Local Examinations Syndicate (UCLES), which is itself a department of the University of Cambridge.