



UNIVERSITY OF CAMBRIDGE INTERNATIONAL EXAMINATIONS  
International General Certificate of Secondary Education

CANDIDATE  
NAME

CENTRE  
NUMBER

--	--	--	--	--

CANDIDATE  
NUMBER

--	--	--	--

\* 9 3 0 6 6 4 3 2 9 5 \*

**CO-ORDINATED SCIENCES**

**0654/61**

Paper 6 Alternative to Practical

**May/June 2011**

**1 hour**

Candidates answer on the Question paper

No Additional Materials are required.

**READ THESE INSTRUCTIONS FIRST**

Write your Centre number, candidate number and name on all the work you hand in.

Write in dark blue or black pen.

You may use a soft pencil for any diagrams, graphs, tables or rough working.

Do not use staples, paper clips, highlighters, glue or correction fluid.

**DO NOT WRITE IN ANY BARCODES.**

Answer **all** questions.

At the end of the examination, fasten all your work securely together.

The number of marks is given in brackets [ ] at the end of each question or part question.

For Examiner's Use	
1	
2	
3	
4	
5	
6	
<b>Total</b>	

This document consists of **18** printed pages and **2** blank pages.



- 1 (a) A student carried out experiments to investigate the composition of *inhaled* and *exhaled* air.

Analysis of **inhaled** air.

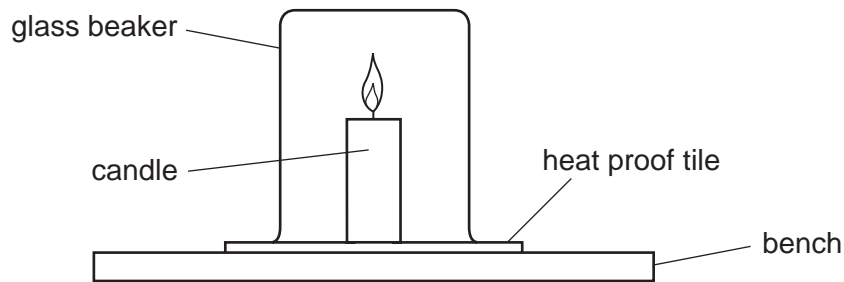

Fig. 1.1

- A student took a 500 cm<sup>3</sup> glass beaker.
- A candle was lit and placed onto a heat proof tile.
- A timer was set to zero.
- The beaker was placed over the candle and the timer started (see Fig. 1.1).
- The timer was stopped when the flame went out.
- The experiment was then repeated.

Analysis of **exhaled** air.

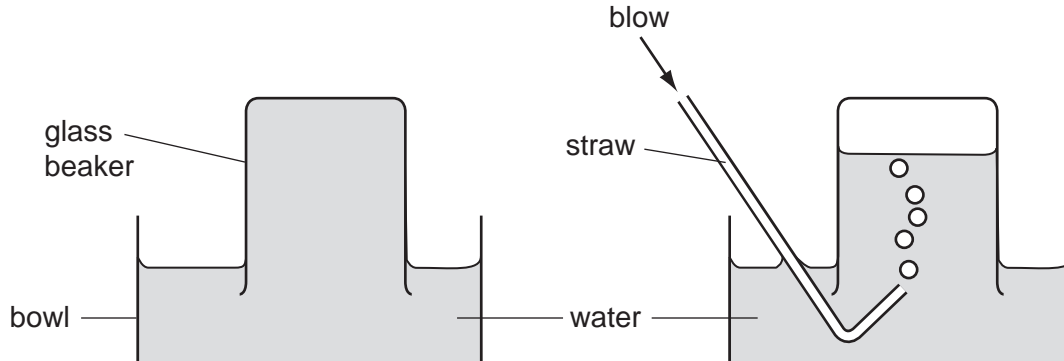

Fig. 1.2

- The 500 cm<sup>3</sup> beaker was filled with water, inverted and placed into a bowl of water (see Fig. 1.2).
- The student blew through a tube until the beaker was full of exhaled air.
- He lit a candle and placed it onto a heat proof tile.
- The timer was set to zero.
- The beaker (of exhaled air) was placed over the candle and the timer started.
- The timer was stopped when the flame went out.
- He then repeated the experiment.



(iv) Describe and explain the difference between the results for inhaled and exhaled air.

.....  
.....  
.....  
..... [2]

(b) In a separate experiment inhaled air was bubbled through tube **A** containing limewater for 30 seconds and the appearance of the limewater recorded.

Exhaled air was bubbled through tube **B** containing limewater for 30 seconds. Fig. 1.4 shows the appearance of the limewater in tubes **A** and **B** after 30 seconds.

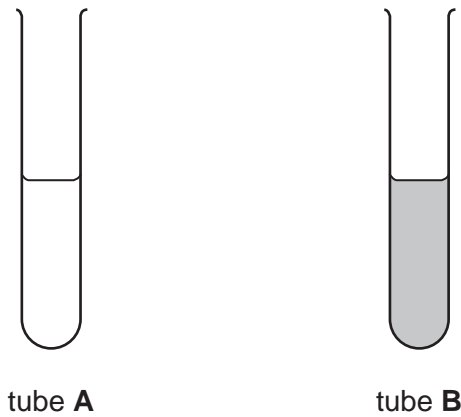

Fig. 1.4

Explain the difference between the appearance of the limewater in tube **A** and tube **B**.

.....  
.....  
.....  
.....  
..... [2]

Please turn over for Question 2.

- 2 (a) A student is investigating how an elastic band stretches when different masses are hung on it.

The apparatus is set up as shown in Fig. 2.1.

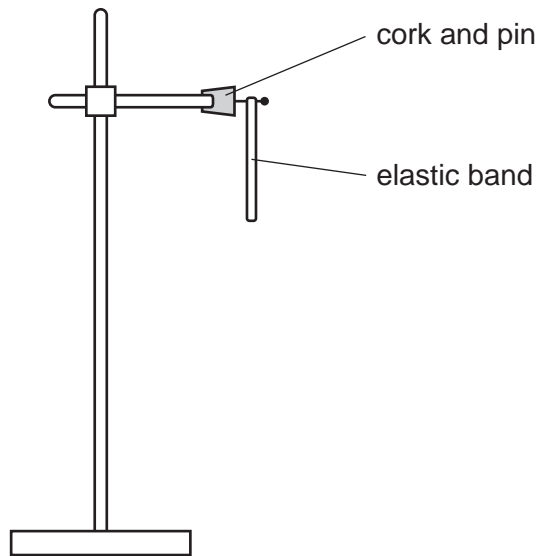

Fig. 2.1

The length of the elastic band is measured with a metre rule, and is recorded in Table 2.1.

A hanger of mass 100g is added to the elastic band and the new length is measured and recorded in Table 2.1. A 100g mass is added to the hanger and the new length of the elastic band is measured and recorded.

Table 2.1

total mass /g	force /N	length of elastic band /mm	total increase in length /mm
0	0	80	0
100	0.1	98	18
200		114	34
300		130	
400		148	
500	0.5	165	85

- (i) Complete column two of Table 2.1 to show the force in Newtons.

[1]

- (ii) Calculate the total increase in length of the elastic band for 300 g and 400 g.

Complete column four of Table 2.1.

For  
Examiner's  
Use

[1]

- (iii) Plot a graph of total increase in length/mm (vertical axis) against force/N (horizontal axis). Draw the best fit straight line.

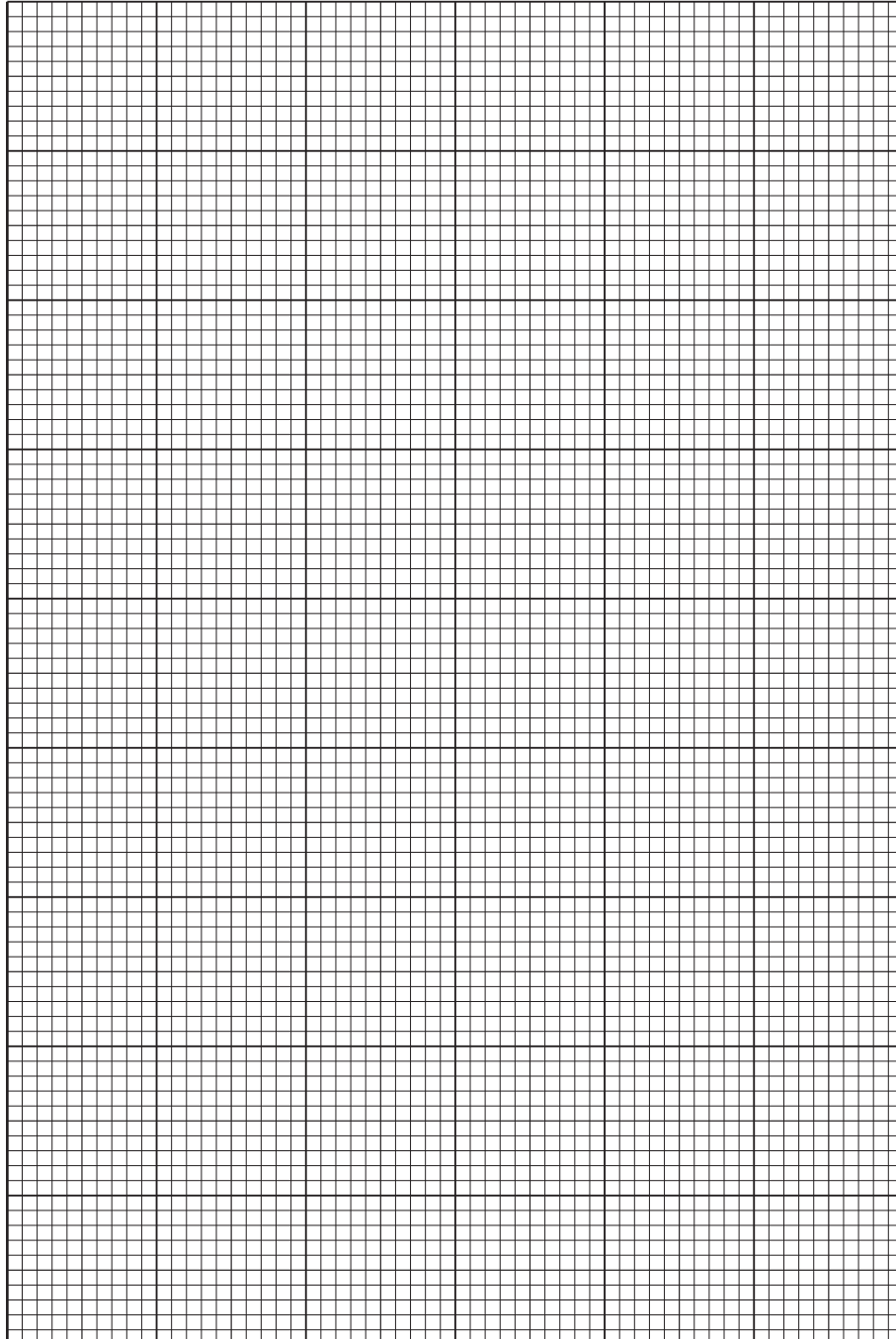

[3]

(iv) Use your graph to describe and explain the relationship between the applied force and the total increase in length.

.....  
.....  
..... [2]

(v) Use your graph to find the total increase in length produced by a mass of 250 g.

Show how you do this on the graph.

total increase in length = ..... mm [2]

(b) If masses were added beyond 500 g, the elastic band would eventually break. On the axes below, sketch the shape of graph that would be obtained.

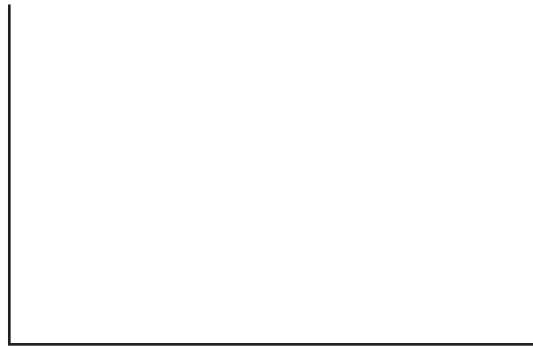

[1]



**BLANK PAGE**

**Please turn over for Question 3.**

- 3 (a) A student is provided with a salt **Z** that contains two cations and one anion.

She places a sample of **Z** in a hard glass test-tube and heats strongly. There is an alkaline gas given off.

- (i) What test does she use and what observation is seen that proves the gas is alkaline?

test .....

observation ..... [2]

- (ii) Suggest a name for the cation that produces this alkaline gas.

..... [1]

- (b) Another sample of **Z** is dissolved in water, and the solution is divided equally into three test-tubes.

- (i) In one test-tube aqueous sodium hydroxide is added drop by drop, until alkaline. A reddish-brown precipitate is produced.

Name the cation that causes this precipitate.

..... [1]

- (ii) In the second test-tube of solution **Z** she tests for chloride ions.

Describe how she does this, naming any chemicals used and the observations for a positive test and a negative test.

.....  
.....  
.....  
.....

..... [3]

The test for chloride ions proved negative.

- (iii) In the third test-tube of solution **Z** she adds a few drops of hydrochloric acid, followed by a few drops of aqueous barium chloride. A white precipitate is produced.

Name the anion that produces this precipitate.

..... [1]

(iv) Why is hydrochloric acid added in the test in (b)(iii)?

.....  
..... [1]

(c) Using all the information from the positive tests, suggest a name for salt Z.

..... [1]

For  
Examiner's  
Use

- 4 (a) A student was investigating the effect of temperature on the activity of yeast. Yeast is a micro-organism that uses enzymes during respiration to break down sugar. This process produces carbon dioxide. In bread the carbon dioxide is trapped as bubbles in the dough. These bubbles cause the bread to rise.

For  
Examiner's  
Use

- The student made up some dough using flour, yeast, sugar and water.
- She divided the dough into six equal parts each of volume  $25 \text{ cm}^3$ .
- She put the first part of the dough in a measuring cylinder, noted the volume and recorded it in Table 4.1. She took the volume reading where the dough touched the sides of the measuring cylinder.
- She put the remaining parts of the dough in five other measuring cylinders.
- She left each measuring cylinder at a different temperature for 30 minutes.
- The student recorded the final volume of dough in each measuring cylinder in Table 4.1.

**Table 4.1**

temperature/ $^{\circ}\text{C}$	total volume, $v$ , of dough/ $\text{cm}^3$
10	
20	31
30	47
40	
50	54
60	25

- (i) Read the scales of the measuring cylinders in Fig. 4.1 at the line where the dough touches the side to find the missing volumes of dough. Enter the values of  $v$  for  $10^{\circ}\text{C}$  and  $40^{\circ}\text{C}$  in Table 4.1. [2]

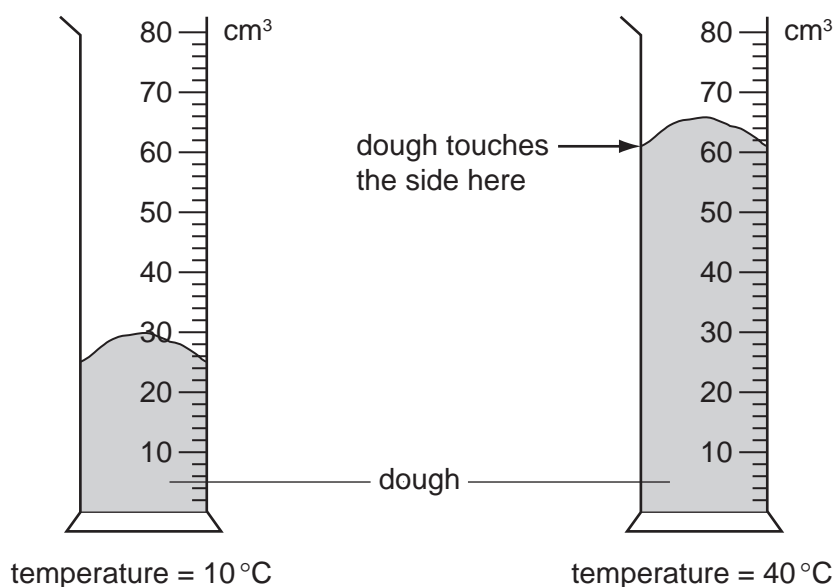

**Fig. 4.1**

- (ii) Calculate the increase in volume of dough for each temperature to complete column two of Table 4.2.

For  
Examiner's  
Use

[2]

Table 4.2

temperature / °C	increase in volume, $v$ , of dough ( $v-25$ ) / $\text{cm}^3$	rate of increase in volume $\text{cm}^3 / \text{min}$ ( $v-25$ ) / 30
10		
20		
30		
40		
50		
60		

- (iii) Calculate the rate of increase in volume of dough for each temperature.

Enter these values in column three of Table 4.2.

[2]

- (b) At which temperature was the rate of increase in volume of dough greatest? This is the optimum temperature.

optimum temperature = ..... °C [1]

(c) Suggest the apparatus used to maintain the different temperatures for the measuring cylinders containing the dough.

.....  
..... [1]

(d) Using your knowledge of the activity of enzymes explain the difference between the results at

20 to 30 °C, .....

.....

40 to 60 °C. ....

..... [2]

- 5 A student has three gold-coloured bracelets, **A**, **B** and **C**. She believes that one, two or all three may be different metals, painted gold.

For  
Examiner's  
Use

To identify the metal in each bracelet she is going to find out the densities of each one.

To do this she has to find the mass and volume of each bracelet.

- (a) To find the volume, she pours exactly  $50\text{ cm}^3$  of water into a  $100\text{ cm}^3$  measuring cylinder.

She carefully drops bracelet **A** into the measuring cylinder and records the new volume in Table 5.1. She calculates the increase in volume. This increase is the volume of the bracelet.

**Table 5.1**

bracelet	<b>A</b>	<b>B</b>	<b>C</b>
volume of water / $\text{cm}^3$	50.0	50.0	50.0
new volume after / $\text{cm}^3$	54.4		
increase in volume / $\text{cm}^3$	4.4		

- (i) Use Fig. 5.1 to read the new volumes for the two bracelets, **B** and **C**. Record these values in Table 5.1. [2]

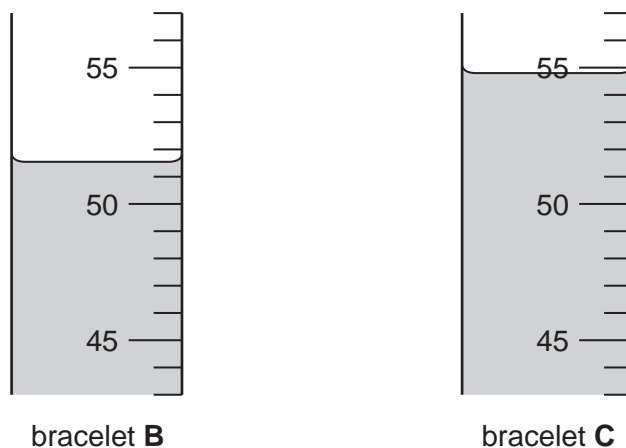

**Fig. 5.1**

- (ii) Calculate the increase in volume for bracelets **B** and **C** and complete Table 5.1. [2]

(b) She now uses a balance to find the mass of bracelet **A**, and records this in Table 5.2.

Table 5.2

bracelet	A	B	C
mass/g	49.8		

Use Fig. 5.2 to find the mass of bracelets **B** and **C** and record the results in Table 5.2. [2]

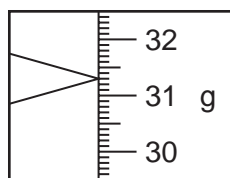

bracelet **B**

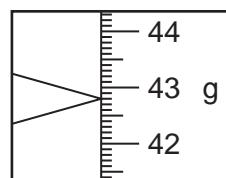

bracelet **C**

Fig. 5.2

(c) Calculate the density of each bracelet using the following equation.

$$\text{density} = \frac{\text{mass}}{\text{volume}}$$

density of bracelet **A** = ..... g/cm<sup>3</sup>

density of bracelet **B** = ..... g/cm<sup>3</sup>

density of bracelet **C** = ..... g/cm<sup>3</sup> [3]

For  
Examiner's  
Use



(d) Use Table 5.3 to suggest what metal each bracelet was made of.

Table 5.3

density in g/cm <sup>3</sup>	metal
2.7	aluminium
7.1	zinc
7.7	bronze
7.9	iron
8.9	copper
10.5	silver
11.3	lead
19.9	gold

bracelet **A** .....

bracelet **B** .....

bracelet **C** .....

[1]

For  
Examiner's  
Use

- 6 (a) The decomposition of hydrogen peroxide into water and oxygen is shown in the equation.



The reaction is speeded up if a catalyst is present. The catalyst is not used up during this reaction.

A student is given samples of copper(II) oxide, manganese(IV) oxide and zinc oxide. He tests them to find the best catalyst.

He pours 25 cm<sup>3</sup> of hydrogen peroxide into a conical flask and sets up the apparatus as in Fig 6.1.

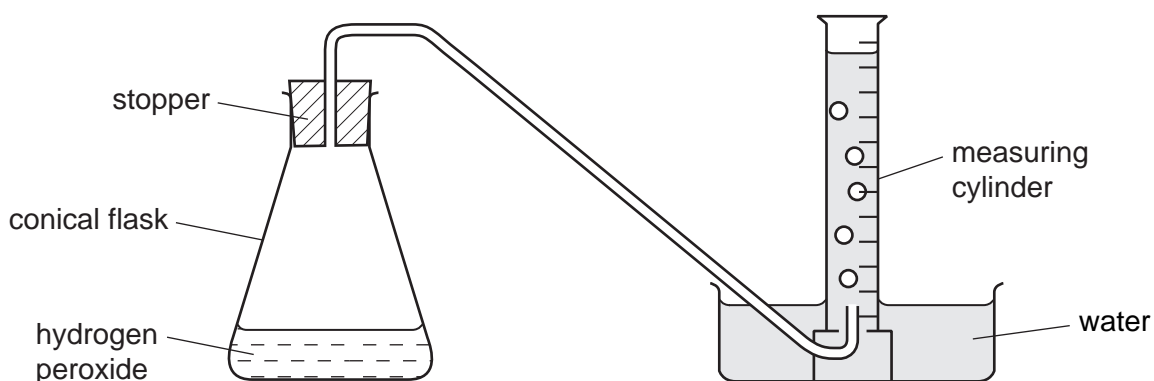

Fig. 6.1

His partner adds a spatula full of copper(II) oxide to the flask and quickly replaces the stopper.

The volume of oxygen gas formed, seen by the displacement of water in the measuring cylinder, is measured every 30 seconds. The results are shown in Table 6.1.

Table 6.1

time / s	volume of oxygen evolved / cm <sup>3</sup>		
	copper(II) oxide	manganese(IV) oxide	zinc oxide
0	0	0	0
30	12	40	24
60	19		
90	24	92	50
120	28	100	59
150	30	100	66
180	32	100	70

- (i) He now repeats the experiment with the same volume of fresh hydrogen peroxide, using manganese(IV) oxide instead of copper(II) oxide. The results are recorded in Table 6.1.

With another sample of hydrogen peroxide he uses zinc oxide. The results are recorded in Table 6.1.

Use Fig. 6.2, to read the volume of gas produced in each measuring cylinder after 60 seconds. Complete Table 6.1. [2]

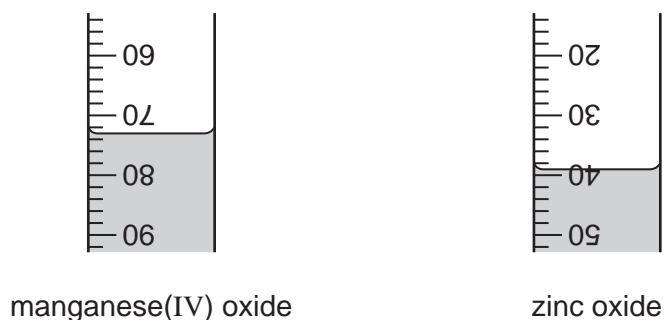
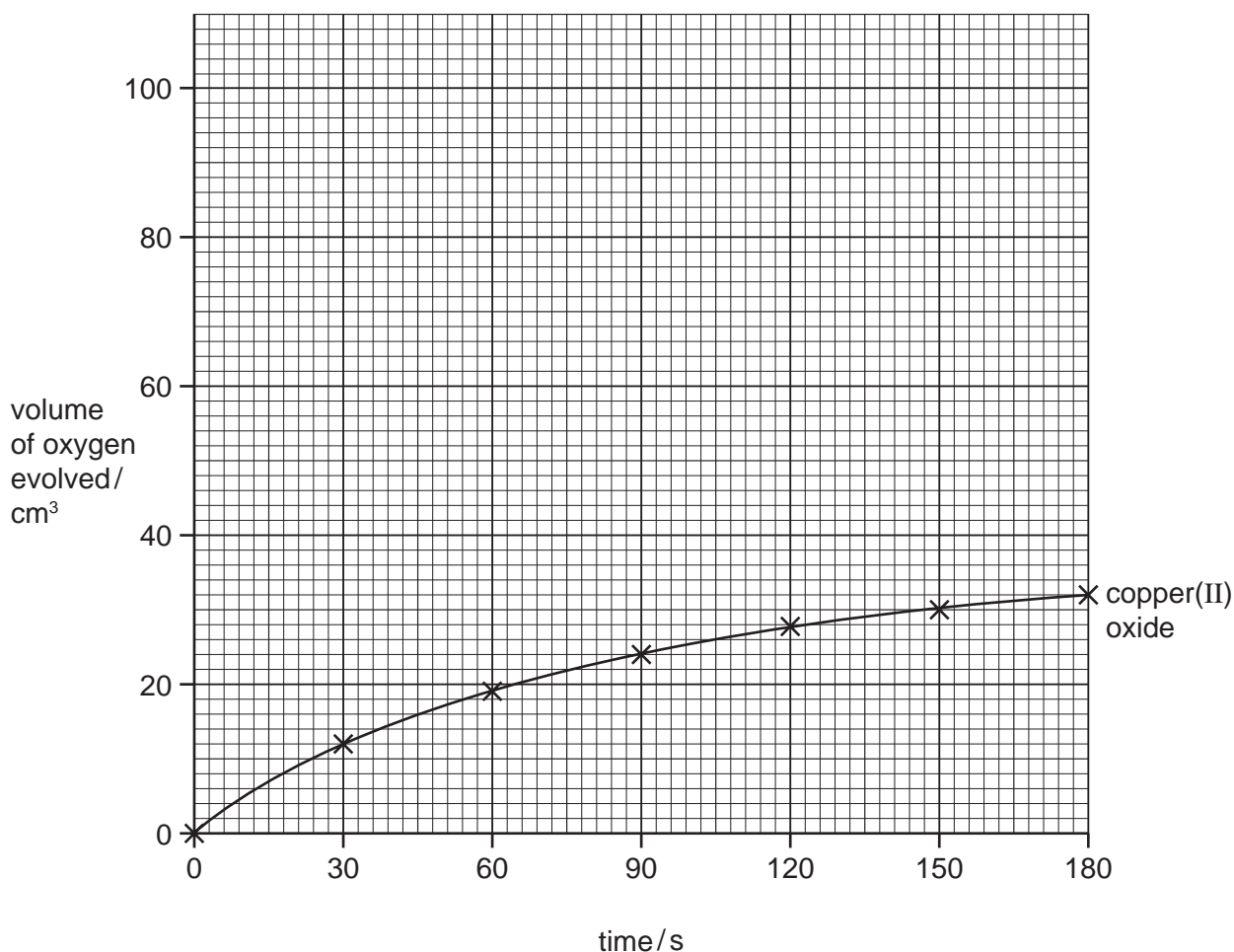

Fig. 6.2

- (ii) On the grid plot a graph of volume of oxygen evolved /  $\text{cm}^3$  against time / s for manganese(IV) oxide and zinc oxide. Draw a smooth curve for each oxide and label them both clearly.



[4]

(iii) Use your graph to suggest which metal oxide makes the best catalyst. Explain your answer.

.....  
.....  
..... [1]

(b) Suggest **one** source of error in the experiment.

.....  
..... [1]

(c) How can you prove that the metal oxide you have named in (a)(iii) is a catalyst?

.....  
.....  
..... [2]

Permission to reproduce items where third-party owned material protected by copyright is included has been sought and cleared where possible. Every reasonable effort has been made by the publisher (UCLES) to trace copyright holders, but if any items requiring clearance have unwittingly been included, the publisher will be pleased to make amends at the earliest possible opportunity.

University of Cambridge International Examinations is part of the Cambridge Assessment Group. Cambridge Assessment is the brand name of University of Cambridge Local Examinations Syndicate (UCLES), which is itself a department of the University of Cambridge.