



UNIVERSITY OF CAMBRIDGE INTERNATIONAL EXAMINATIONS  
International General Certificate of Secondary Education

**CO-ORDINATED SCIENCES**

**0654/11**

Paper 1 Multiple Choice

**May/June 2011**

**45 minutes**

Additional Materials: Multiple Choice Answer Sheet  
Soft clean eraser  
Soft pencil (type B or HB is recommended)

\* 3 5 5 1 8 4 8 1 2 9 \*

**READ THESE INSTRUCTIONS FIRST**

Write in soft pencil.

Do not use staples, paper clips, highlighters, glue or correction fluid.

Write your name, Centre number and candidate number on the Answer Sheet in the spaces provided unless this has been done for you.

There are **forty** questions on this paper. Answer **all** questions. For each question there are four possible answers **A, B, C** and **D**.

Choose the **one** you consider correct and record your choice in **soft pencil** on the separate Answer Sheet.

**Read the instructions on the Answer Sheet very carefully.**

Each correct answer will score one mark. A mark will not be deducted for a wrong answer.

Any rough working should be done in this booklet.

A copy of the Periodic Table is printed on page 16.

This document consists of **15** printed pages and **1** blank page.



1 The diagram shows four vertebrate animals.

P

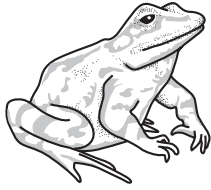

Q

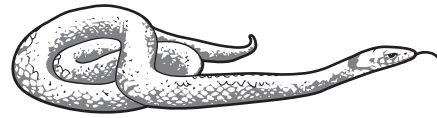

R

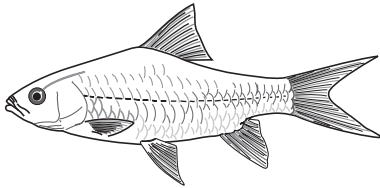

S

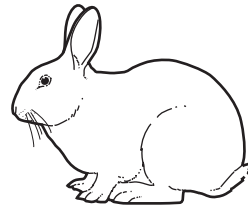

Which animals have lungs?

- A** P, Q and R    **B** Q, R and S    **C** R, S and P    **D** S, P and Q

2 The diagram shows a root hair cell.

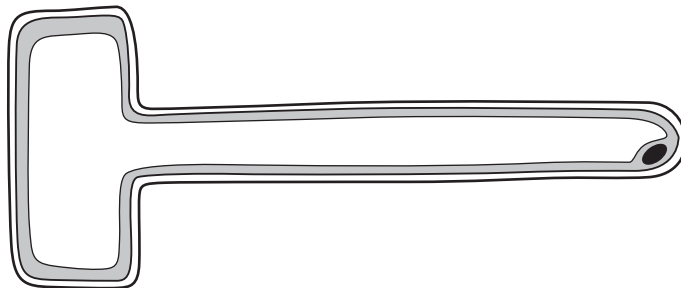

What shows that it is a plant cell?

- A** It has a large surface area.  
**B** It has a large vacuole.  
**C** It has no cell membrane.  
**D** It has no cell wall.

3 Which molecule carries energy into a cell and which is a process that uses this energy?

	molecule	process
<b>A</b>	glucose	growth
<b>B</b>	iron	movement
<b>C</b>	protein	digestion
<b>D</b>	starch	storage

4 The diagram shows a section through the heart.

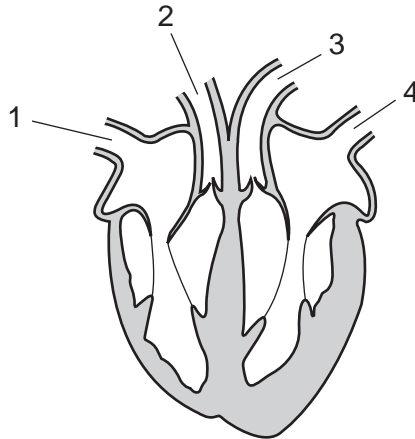

Which two blood vessels are arteries?

- A** 1 and 2      **B** 2 and 3      **C** 3 and 4      **D** 4 and 1

5 Which process releases energy in all living things?

- A** breathing  
**B** digestion  
**C** muscle contraction  
**D** respiration

6 Tests were carried out on a clear liquid. The table shows the results.

test	result
biuret	purple colour
ethanol	white colour
iodine	brown colour

What did the clear liquid contain?

	fat	protein	starch	
<b>A</b>	✓	✓	✓	key ✓ = yes x = no
<b>B</b>	✓	✓	x	
<b>C</b>	✓	x	✓	
<b>D</b>	x	✓	✓	

7 The diagram shows part of the alimentary canal.

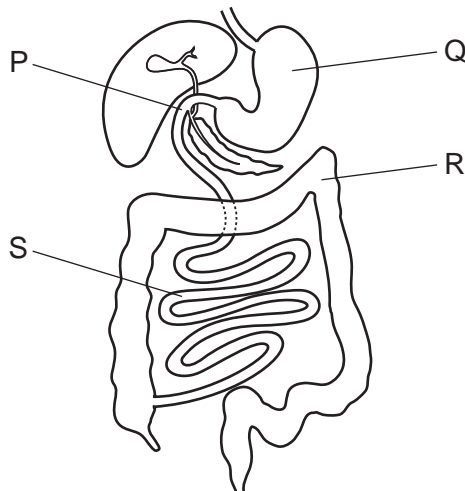

Where is bile added and where is acid released?

	addition of bile	release of acid
<b>A</b>	P	Q
<b>B</b>	Q	R
<b>C</b>	R	S
<b>D</b>	S	P

- 8 What happens shortly after eating a large amount of sugar?
- A More insulin is secreted by the pancreas.
  - B More urea is made in the liver.
  - C More urine is excreted by the kidneys.
  - D More water is removed from the blood.
- 9 What passes from a mother to a fetus in her uterus?
- A blood platelets
  - B mineral ions
  - C plasma
  - D red blood cells
- 10 Why is seed dispersal important?
- A It causes the development of a fruit.
  - B It makes seeds more fertile.
  - C It prevents asexual reproduction.
  - D It reduces competition between seedlings.
- 11 Which is an example of cloning?
- A pollinating flowers by insects
  - B producing offspring by sexual intercourse
  - C producing plants by tissue culture
  - D seeds forming in an ovary
- 12 What is an ecosystem?
- A a community and its habitat
  - B a group of organisms and their predators
  - C all the organisms in a food chain
  - D where an organism lives

13 The diagram shows a short food chain.

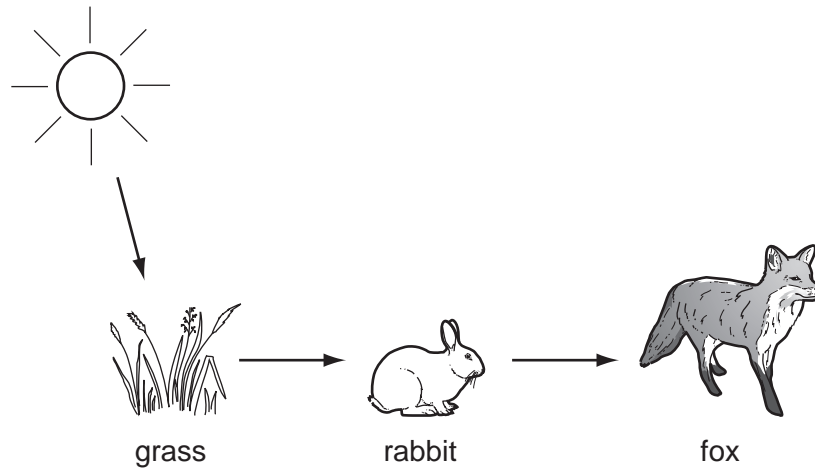

In the food chain, what is the importance of the rabbit?

- A It absorbs carbon dioxide.
- B It absorbs the Sun's energy.
- C It passes on energy from plants.
- D It releases oxygen.

14 The graph shows the changes in temperature when a substance is cooled.

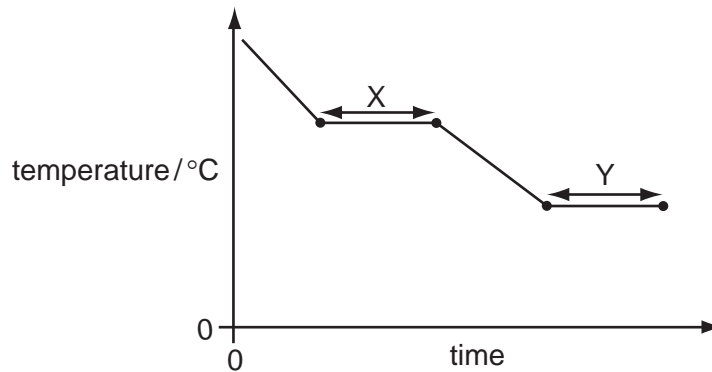

Which describes the processes occurring at X and Y?

	X	Y
<b>A</b>	boiling	melting
<b>B</b>	condensing	freezing
<b>C</b>	freezing	condensing
<b>D</b>	melting	boiling

15 Which trends in physical properties are correct for the alkali metals down Group I?

	hardness	melting point
<b>A</b>	decreases	decreases
<b>B</b>	decreases	increases
<b>C</b>	increases	decreases
<b>D</b>	increases	increases

16 Large hydrocarbons can be .....1..... to make smaller, more useful molecules.

Small hydrocarbon molecules can be .....2..... to make long molecules.

Which words correctly complete gaps 1 and 2?

	1	2
<b>A</b>	cracked	distilled
<b>B</b>	cracked	polymerised
<b>C</b>	distilled	polymerised
<b>D</b>	distilled	cracked

17 What is made when amino acids join together in a large chain?

- A** cellulose
- B** glucose
- C** protein
- D** starch

18 Some properties of three substances are shown.

substance	melting point /°C	boiling point /°C	electrical conductivity when molten
W	801	1413	good
X	-111	-78	poor
Y	1610	2230	poor

What are the structures of W, X and Y?

	giant covalent structure	giant ionic structure	molecular structure
<b>A</b>	W	Y	X
<b>B</b>	X	W	Y
<b>C</b>	Y	W	X
<b>D</b>	Y	X	W

19 How is carbon (coke) used in the extraction of iron from iron oxide?

- A** as an anode
- B** as a cathode
- C** as an oxidising agent
- D** as a reducing agent

20 Electrolysis of sodium chloride is used to obtain chlorine.

In what form is sodium chloride electrolysed and at which electrode is the chlorine obtained?

	form of sodium chloride	electrode at which chlorine is obtained
<b>A</b>	in aqueous solution	anode
<b>B</b>	in aqueous solution	cathode
<b>C</b>	solid	anode
<b>D</b>	solid	cathode



21 A solution is tested by adding acidified silver nitrate solution.

Which ion causes the white precipitate to form?

- A chloride ions,  $Cl^-$
- B copper ions,  $Cu^{2+}$
- C hydroxide ions,  $OH^-$
- D sodium ions,  $Na^+$

22 Sodium hydroxide solution is added to hydrochloric acid.

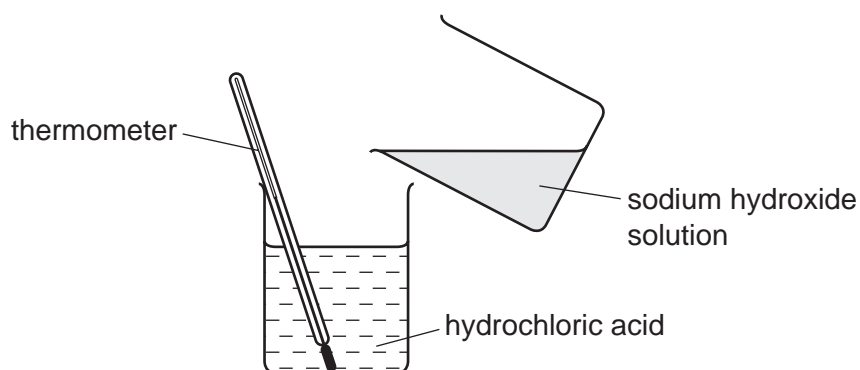

Which shows how the pH and temperature change as the reaction takes place?

	pH	temperature
<b>A</b>	decrease	decrease
<b>B</b>	decrease	increase
<b>C</b>	increase	decrease
<b>D</b>	increase	increase

23 Which statements about a positive test for a nitrate ion are correct?

- 1 Aluminium is used.
- 2 The nitrate ion is reduced to ammonia.
- 3 Ammonia turns damp litmus paper red.

- A** 1, 2 and 3
- B** 1 and 2 only
- C** 1 and 3 only
- D** 2 and 3 only



28 A student needs to find the density of a large cubic block of wood.

Which two pieces of apparatus should she use?

- A balance and metre rule
- B balance and thermometer
- C measuring cylinder and metre rule
- D measuring cylinder and thermometer

29 In an experiment, a student measures the time taken for an object to fall to the ground. He carries out the experiment ten times. The table shows his results.

time/s	26.4	26.8	26.4	24.4	24.0	26.8	25.4	23.4	26.4	24.0
--------	------	------	------	------	------	------	------	------	------	------

Which value should the student use?

- A 24.0 s
- B 25.4 s
- C 26.4 s
- D 26.8 s

30 One side of a cube stands on the ground.

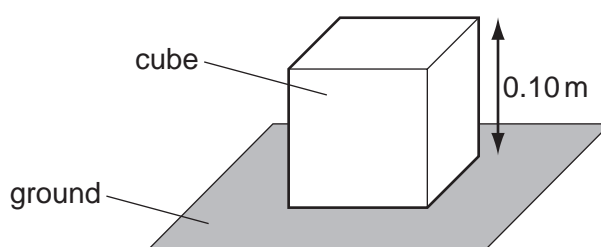

The cube weighs 200 N and its sides are 0.10 m long.

How much pressure does the cube exert on the ground?

- A 2.0 Pa
- B 20 Pa
- C 2000 Pa
- D 20 000 Pa

31 What is meant by the current in a wire?

- A the charge flowing through the wire per second
- B the energy the wire can transfer elsewhere per second
- C the power the wire can produce per second
- D the work the wire does per second

32 Which group contains only secondary colours of light?

- A cyan, green, magenta
- B cyan, green, yellow
- C green, magenta, yellow
- D yellow, cyan, magenta

33 Two cars have different masses and different speeds as shown.

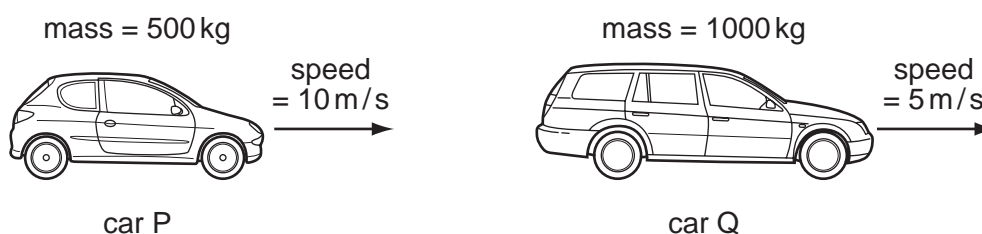

How do the momentum and the kinetic energy of the two cars compare?

	momentum	kinetic energy
<b>A</b>	P greater than Q	P less than Q
<b>B</b>	P equal to Q	P greater than Q
<b>C</b>	P equal to Q	P equal to Q
<b>D</b>	P less than Q	P equal to Q

34 A satellite orbits the Earth.

Is the satellite in a gravitational field and is the satellite in a magnetic field?

	a gravitational field	a magnetic field
<b>A</b>	✓	✓
<b>B</b>	✓	✗
<b>C</b>	✗	✓
<b>D</b>	✗	✗

key

✓ = in field

✗ = not in field

35 Microphones and earphones are both used with audio equipment.

Which energy change takes place in a microphone and which takes place in an earphone?

	microphone	earphone
<b>A</b>	electrical to sound	electrical to sound
<b>B</b>	electrical to sound	sound to electrical
<b>C</b>	sound to electrical	electrical to sound
<b>D</b>	sound to electrical	sound to electrical

36 The diagram shows the basic structure of a cathode-ray tube in an oscilloscope.

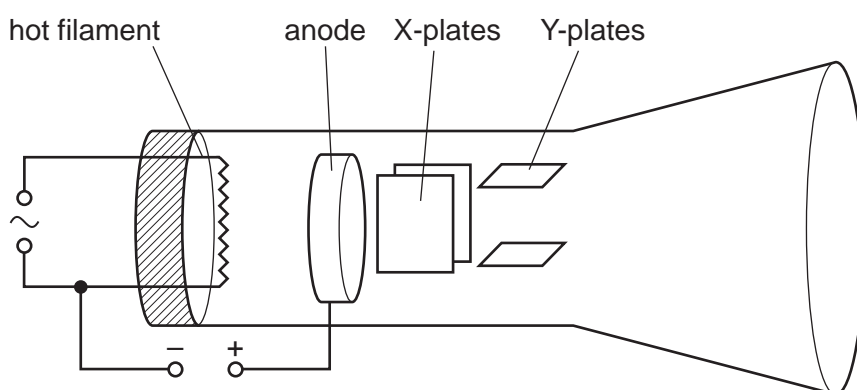

From which component do the cathode rays start?

- A** the anode
- B** the hot filament
- C** the X-plates
- D** the Y-plates

37 Which row describes the properties of beta radiation?

	electromagnetic	ionising
<b>A</b>	✓	✓
<b>B</b>	✓	x
<b>C</b>	x	✓
<b>D</b>	x	x

key  
 ✓ = yes  
 x = no

- 38 Which process is used in a nuclear power station and which nuclear change happens in this process?

	process used	nuclear change
<b>A</b>	fission	heavy nuclei split
<b>B</b>	fission	light nuclei join together
<b>C</b>	fusion	heavy nuclei split
<b>D</b>	fusion	light nuclei join together

- 39 Electrical energy from a power station is used a long distance away from it.

Which row shows the type of current needed and the device used for efficient transmission?

	type of current	device
<b>A</b>	alternating	dynamo
<b>B</b>	alternating	transformer
<b>C</b>	direct	dynamo
<b>D</b>	direct	transformer

- 40 An electronic circuit is used as a temperature detector.



The current in the detector is small. The detector operates a component that allows it to control a larger current in a heater.

Which component is suitable?

- A** a diode
- B** a dynamo
- C** a reed relay
- D** a transformer



**DATA SHEET**  
**The Periodic Table of the Elements**

		Group																																																																																						
I	II	III	IV	V	VI	VII	0																																																																																	
		1 <b>H</b> Hydrogen 1											4 <b>He</b> Helium 2																																																																											
7 <b>Li</b> Lithium 3	9 <b>Be</b> Beryllium 4											19 <b>F</b> Fluorine 9	20 <b>Ne</b> Neon 10																																																																											
23 <b>Na</b> Sodium 11	24 <b>Mg</b> Magnesium 12	27 <b>Al</b> Aluminium 13	28 <b>Si</b> Silicon 14	31 <b>P</b> Phosphorus 15	32 <b>S</b> Sulfur 16	35.5 <b>Cl</b> Chlorine 17	40 <b>Ar</b> Argon 18						84 <b>Kr</b> Krypton 36																																																																											
39 <b>K</b> Potassium 19	40 <b>Ca</b> Calcium 20	70 <b>Ga</b> Gallium 31	73 <b>Ge</b> Germanium 32	75 <b>As</b> Arsenic 33	79 <b>Se</b> Selenium 34	80 <b>Br</b> Bromine 35	84 <b>Kr</b> Krypton 36						131 <b>Xe</b> Xenon 54																																																																											
85 <b>Rb</b> Rubidium 37	88 <b>Sr</b> Strontium 38	115 <b>In</b> Indium 49	119 <b>Sn</b> Tin 50	122 <b>Sb</b> Antimony 51	128 <b>Te</b> Tellurium 52	127 <b>I</b> Iodine 53	131 <b>Xe</b> Xenon 54						209 <b>Po</b> Polonium 84																																																																											
133 <b>Cs</b> Caesium 55	137 <b>Ba</b> Barium 56	204 <b>Tl</b> Thallium 81	207 <b>Pb</b> Lead 82	209 <b>Bi</b> Bismuth 83	210 <b>Po</b> Polonium 84	210 <b>At</b> Astatine 85	210 <b>Rn</b> Radon 86						210 <b>Rn</b> Radon 86																																																																											
226 <b>Ra</b> Radium 88	227 <b>Ac</b> Actinium 89											227 <b>Ac</b> Actinium 89																																																																												
*58-71 Lanthanoid series												175 <b>Lu</b> Lutetium 71																																																																												
†90-103 Actinoid series												102 <b>No</b> Nobelium 102																																																																												
<table border="1" style="width: 100%; border-collapse: collapse; text-align: center;"> <tr> <td style="width: 20px;">a</td> <td style="width: 20px;"><b>X</b></td> <td style="width: 20px;">b</td> </tr> <tr> <td>Key</td> <td>a = relative atomic mass</td> <td>X = atomic symbol</td> </tr> <tr> <td></td> <td>b = proton (atomic) number</td> <td></td> </tr> </table>												a	<b>X</b>	b	Key	a = relative atomic mass	X = atomic symbol		b = proton (atomic) number		169 <b>Tm</b> Thulium 69																																																																			
a	<b>X</b>	b																																																																																						
Key	a = relative atomic mass	X = atomic symbol																																																																																						
	b = proton (atomic) number																																																																																							
<table border="1" style="width: 100%; border-collapse: collapse; text-align: center;"> <tr> <td style="width: 20px;">140</td> <td style="width: 20px;"><b>Ce</b></td> <td style="width: 20px;">141</td> <td style="width: 20px;"><b>Pr</b></td> <td style="width: 20px;">144</td> <td style="width: 20px;"><b>Nd</b></td> <td style="width: 20px;">150</td> <td style="width: 20px;"><b>Sm</b></td> <td style="width: 20px;">152</td> <td style="width: 20px;"><b>Eu</b></td> <td style="width: 20px;">157</td> <td style="width: 20px;"><b>Gd</b></td> <td style="width: 20px;">162</td> <td style="width: 20px;"><b>Dy</b></td> <td style="width: 20px;">165</td> <td style="width: 20px;"><b>Ho</b></td> <td style="width: 20px;">167</td> <td style="width: 20px;"><b>Er</b></td> <td style="width: 20px;">169</td> <td style="width: 20px;"><b>Tm</b></td> <td style="width: 20px;">173</td> <td style="width: 20px;"><b>Yb</b></td> <td style="width: 20px;">175</td> <td style="width: 20px;"><b>Lu</b></td> </tr> <tr> <td>58</td> <td>Cerium</td> <td>59</td> <td>Praseodymium</td> <td>60</td> <td>Neyodymium</td> <td>61</td> <td>Promethium</td> <td>62</td> <td>Samarium</td> <td>63</td> <td>Europlum</td> <td>64</td> <td>Gadolinium</td> <td>65</td> <td>Terbium</td> <td>66</td> <td>Dysprosium</td> <td>67</td> <td>Holmium</td> <td>68</td> <td>Erbium</td> <td>69</td> <td>Thulium</td> <td>70</td> <td>Ytterbium</td> </tr> <tr> <td>90</td> <td>Thorium</td> <td>91</td> <td>Protactinium</td> <td>92</td> <td>Uranium</td> <td>93</td> <td>Neptunium</td> <td>94</td> <td>Plutonium</td> <td>95</td> <td>Americium</td> <td>96</td> <td>Curium</td> <td>97</td> <td>Berkelium</td> <td>98</td> <td>Californium</td> <td>99</td> <td>Einsteinium</td> <td>100</td> <td>Fermium</td> <td>101</td> <td>Mendelevium</td> <td>102</td> <td>Nobelium</td> </tr> </table>												140	<b>Ce</b>	141	<b>Pr</b>	144	<b>Nd</b>	150	<b>Sm</b>	152	<b>Eu</b>	157	<b>Gd</b>	162	<b>Dy</b>	165	<b>Ho</b>	167	<b>Er</b>	169	<b>Tm</b>	173	<b>Yb</b>	175	<b>Lu</b>	58	Cerium	59	Praseodymium	60	Neyodymium	61	Promethium	62	Samarium	63	Europlum	64	Gadolinium	65	Terbium	66	Dysprosium	67	Holmium	68	Erbium	69	Thulium	70	Ytterbium	90	Thorium	91	Protactinium	92	Uranium	93	Neptunium	94	Plutonium	95	Americium	96	Curium	97	Berkelium	98	Californium	99	Einsteinium	100	Fermium	101	Mendelevium	102	Nobelium	101 <b>Md</b> Mendelevium 101
140	<b>Ce</b>	141	<b>Pr</b>	144	<b>Nd</b>	150	<b>Sm</b>	152	<b>Eu</b>	157	<b>Gd</b>	162	<b>Dy</b>	165	<b>Ho</b>	167	<b>Er</b>	169	<b>Tm</b>	173	<b>Yb</b>	175	<b>Lu</b>																																																																	
58	Cerium	59	Praseodymium	60	Neyodymium	61	Promethium	62	Samarium	63	Europlum	64	Gadolinium	65	Terbium	66	Dysprosium	67	Holmium	68	Erbium	69	Thulium	70	Ytterbium																																																															
90	Thorium	91	Protactinium	92	Uranium	93	Neptunium	94	Plutonium	95	Americium	96	Curium	97	Berkelium	98	Californium	99	Einsteinium	100	Fermium	101	Mendelevium	102	Nobelium																																																															

The volume of one mole of any gas is 24 dm<sup>3</sup> at room temperature and pressure (r.t.p.).

Permission to reproduce items where third-party owned material protected by copyright is included has been sought and cleared where possible. Every reasonable effort has been made by the publisher (UCLES) to trace copyright holders, but if any items requiring clearance have unwittingly been included, the publisher will be pleased to make amends at the earliest possible opportunity.

University of Cambridge International Examinations is part of the Cambridge Assessment Group. Cambridge Assessment is the brand name of University of Cambridge Local Examinations Syndicate (UCLES), which is itself a department of the University of Cambridge.