

UNIVERSITY OF CAMBRIDGE INTERNATIONAL EXAMINATIONS
International General Certificate of Secondary Education

CANDIDATE
NAME

CENTRE
NUMBER

--	--	--	--	--

CANDIDATE
NUMBER

--	--	--	--

COMBINED SCIENCE

0653/63

Paper 6 Alternative to Practical

October/November 2010

1 hour

Candidates answer on the Question paper

No Additional Materials are required.



READ THESE INSTRUCTIONS FIRST

Write your Centre number, candidate number and name on all the work you hand in.

Write in dark blue or black pen.

You may use a soft pencil for any diagrams, graphs, tables or rough working.

Do not use staples, paper clips, highlighters, glue or correction fluid.

DO NOT WRITE IN ANY BARCODES.

Answer **all** questions.

At the end of the examination, fasten all your work securely together.

The number of marks is given in brackets [] at the end of each question or part question.

For Examiner's Use	
1	
2	
3	
4	
5	
6	
Total	

This document consists of **18** printed pages and **2** blank pages.



- 1 A student did an experiment to investigate heat loss from water. The tubes shown in Fig. 1.1 represented animals in different conditions.

For
Examiner's
Use

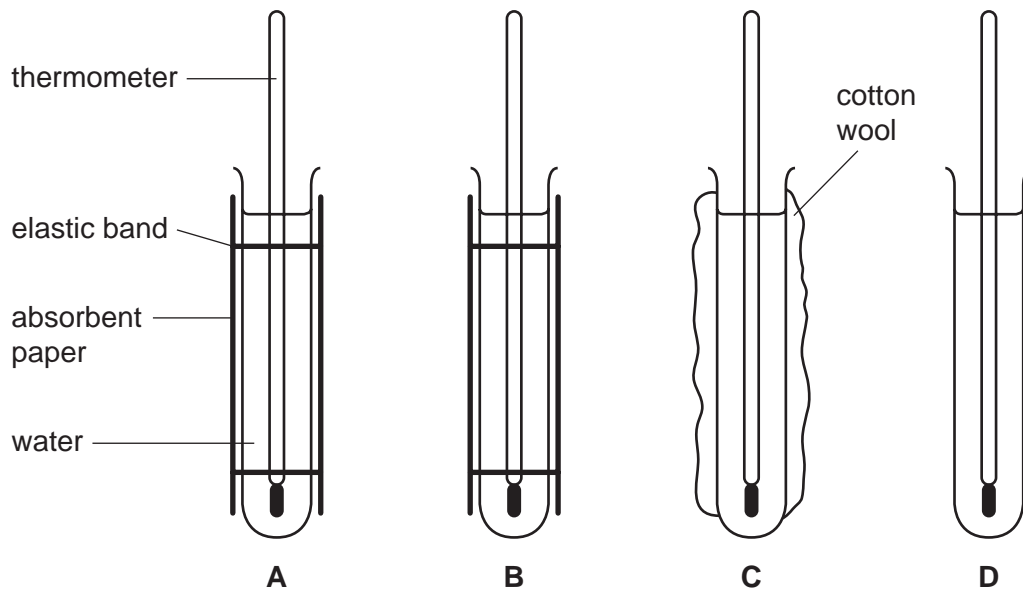

Fig. 1.1

- The student wrapped absorbent paper around **tube A** and **tube B**, then soaked the paper around **tube B** with water.
- She covered **tube C** with a layer of cotton wool and she left **tube D** uncovered.
- The student then poured water at a temperature of 50°C into the four tubes and started timing.
- She took the temperature of the tubes every minute for five minutes.
- The results are shown in Table 1.1.

Table 1.1

time / min	temperature / °C			
	tube A	tube B	tube C	tube D
0	50	50	50	50
1			42	38
2	39	30	41	37
3	38	29	40	35
4	37	28	39	34
5	36	27	38	33

- (a) Read the thermometer scales for **tube A** and **tube B** in Fig. 1.2 and enter the readings in Table 1.1. [2]

For
Examiner's
Use

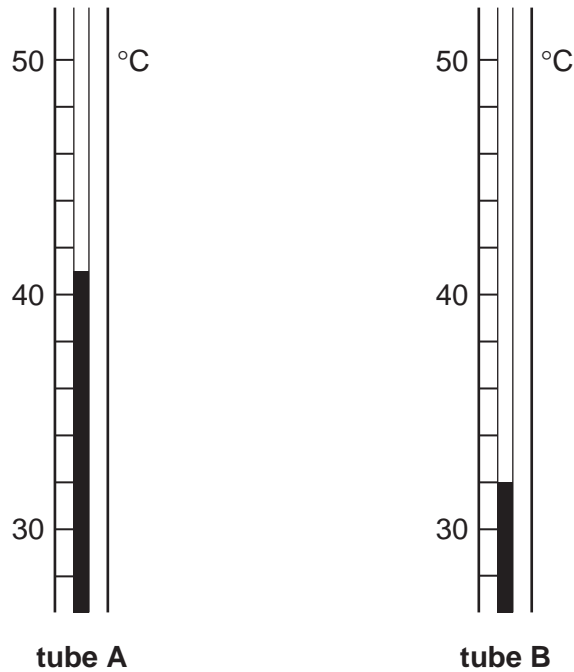

Fig. 1.2

- (b) (i) For each tube, subtract the temperature of the water after 5 minutes from 50 °C, to give **T**, the total temperature drop. Record the results in Table 1.2.
- (ii) For each tube, divide **T** by 5 to give the average temperature drop per minute. Record the results in Table 1.2. [4]

Table 1.2

tube	T , total temperature drop/°C	average temperature drop/°C per min
A		
B		
C		
D		

- (c) (i) Suggest a reason for the relatively large initial drop in temperature.

.....

- (ii) Explain the purpose of **tube D**.

.....
 [2]

(d) The absorbent paper represents skin. Compare the results of **tube A** and **tube B** to describe the benefits of sweating.

*For
Examiner's
Use*

.....
.....
.....

Explain your answer in terms of heat transfer.

.....
..... [2]

Please turn over for Question 2.

- 2 (a) (i) A student is given a mixture of sand, iron filings and zinc sulfate powder. She is asked to separate them.

What can she use to separate out the iron filings?

..... [1]

- (ii) She adds water to the remaining sand and zinc sulfate and stirs the mixture.

Draw a labelled diagram of the apparatus she can use to separate out the sand.

[2]

- (iii) She is now left with zinc sulfate solution. Describe how she can obtain dry crystals of zinc sulfate.

.....

 [2]

- (b) The student shows the crystals to a friend, who does not believe they are zinc sulfate.

- (i) Describe a test that will show sulfate ions are present in a solution of the crystals.

test

result [2]

- (ii) Now, describe a test that will show that zinc ions are present in the solution.

test

result [2]

(c) The separation in (a)(ii) will not work if the mixture contains sand and lead sulfate instead of zinc sulfate.

Suggest a reason for this.

..... [1]

*For
Examiner's
Use*

- 3 (a) An electrical circuit is set up as shown below in Fig. 3.1.

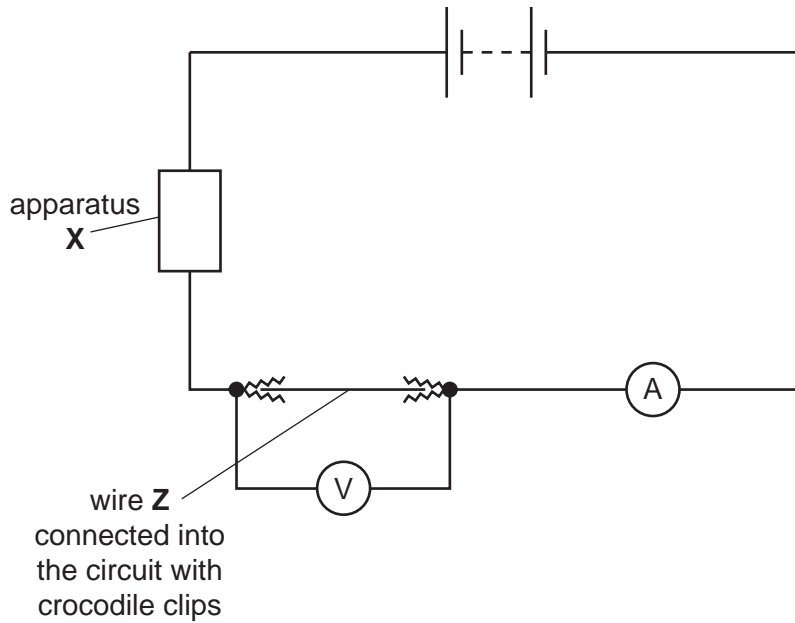

Fig. 3.1

When apparatus X is adjusted, the potential difference across wire Z and the current are changed.

Name apparatus X.

..... [1]

Table 3.1 shows some ammeter readings at different voltmeter readings.

Table 3.1

voltmeter reading/V	1.0	2.1	4.0	5.1	7.2	9.0	10.1
ammeter reading/A	0.17			0.60	0.95	1.08	1.20

- (b) Read the ammeters in Fig. 3.2 and complete Table 3.1.

[2]

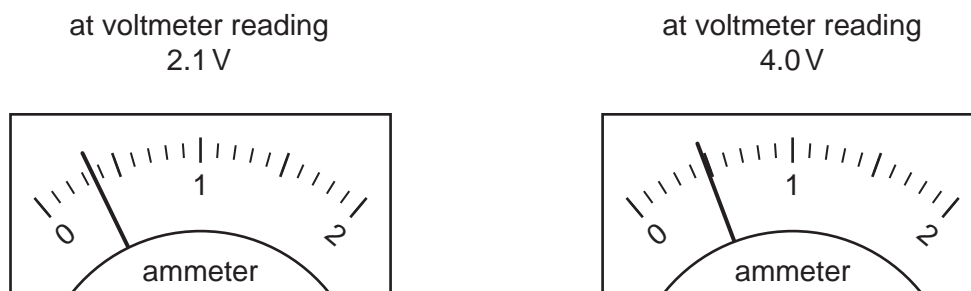
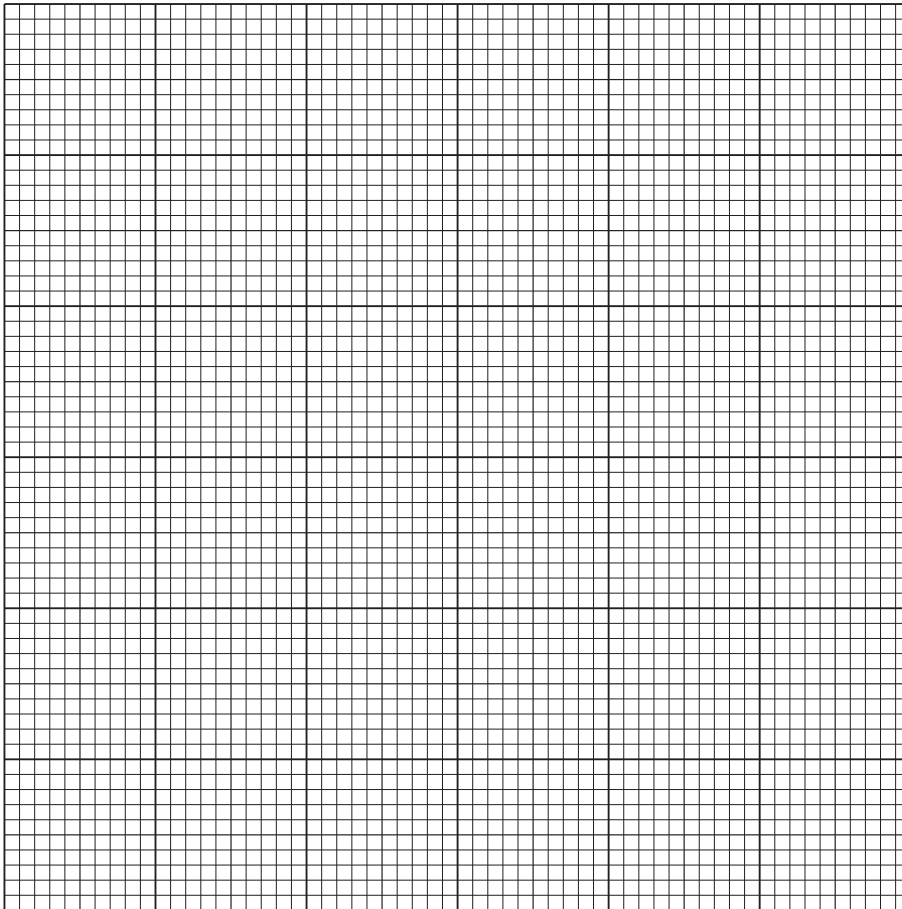

Fig. 3.2

- (c) (i) Use the grid below to plot a graph of the **voltmeter readings** (vertical axis) against the **ammeter readings** (horizontal axis). Draw the line of best fit.

For
Examiner's
Use



[4]

- (ii) Use the graph to state the mathematical relationship between the current in amps and the potential difference in volts.

..... [1]

- (d) When apparatus **X** is set to minimum resistance the ammeter reading suddenly falls to zero.

Suggest a reason for this.

..... [1]

- (e) Suggest how the ammeter readings in Table 3.1 will change if an increased length of wire **Z** is used.

..... [1]

- 4 This question is about osmosis. Water will move from a dilute solution into a concentrated solution through a partially permeable membrane.

For
Examiner's
Use

A student knew that if she put potato pieces into a range of solutions, water would enter the potato if the solution was more dilute than the potato. Water would leave the potato if the solution was more concentrated than the potato.

A student wanted to find the concentration inside the potato.

- She prepared salt solutions of different concentrations and poured each one into a separate petri dish.
- She prepared 5 chips of potato of mass approximately 5 g. She recorded the mass of each one in Table 4.1.
- She cut the first chip into 10 pieces and placed them into the first solution. See Fig. 4.1.
- She repeated this with the rest of the chips so that each solution contained one of the weighed and cut chips.
- She left the pieces in the solutions for 30 minutes. After this time she took the pieces out of each dish, blotted excess solution from the pieces, then weighed them again and recorded their new masses.

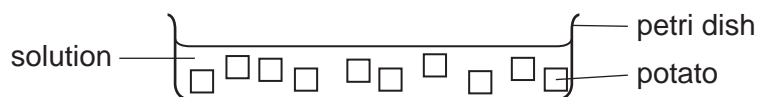

Fig. 4.1

Results

Table 4.1

concentration of salt solution in mol/dm ³	first mass of potato/g	new mass of potato/g	change in mass/g
0 (distilled water)	5.2	5.5	
0.1	5.3	5.4	
0.2	5.2	5.1	
0.3	5.3	5.0	
0.4	5.2	4.7	

- (a) Subtract the new mass from the first mass to find the change in mass of the potato in each salt solution and complete Table 4.1. [2]

(b) On the grid provided draw a line graph of **change in mass** against **concentration of salt solution**.

For
Examiner's
Use

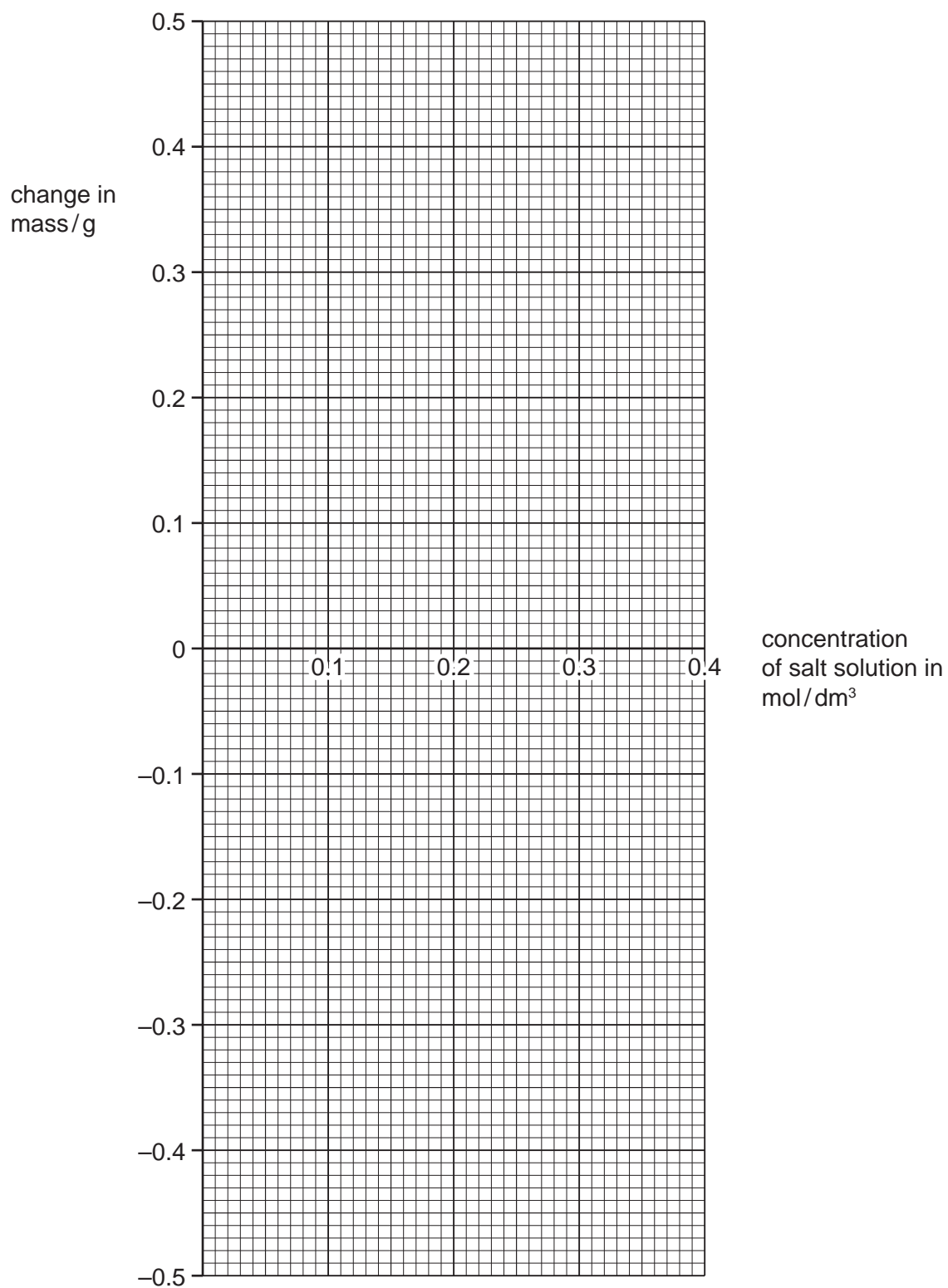

[3]

(c) The concentration inside the potato is equal to the concentration of salt solution that produces no change in mass.

Find this value from the graph.

concentration inside the potato = mol/dm³ [1]

(d) (i) Describe **one** possible source of error in her experiment.

.....
.....

(ii) How can she improve the accuracy of her results?

.....
..... [2]

(e) The solution of concentration 0 mol/dm³ was distilled (deionised) water.

Suggest and explain what would happen if red blood cells were placed in distilled water.

suggestion
.....

explanation
.....
..... [2]

Please turn over for Question 5.

5 (a) A student is investigating the reaction between marble chips and hydrochloric acid.

- A marble chip is placed in a test-tube.
- A piece of graph paper is placed behind the tube.
- 3 cm³ of 0.25 mol / dm³ hydrochloric acid is added to the marble and the stopclock is started.
- When he can **clearly see** the graph paper through the contents of the tube, he stops the clock.
- He records the time in Table 5.1.
- The experiment is repeated using different concentrations of acid.

For
Examiner's
Use

Use the diagrams of the stopclocks in Fig. 5.1 to complete Table 5.1.

[2]

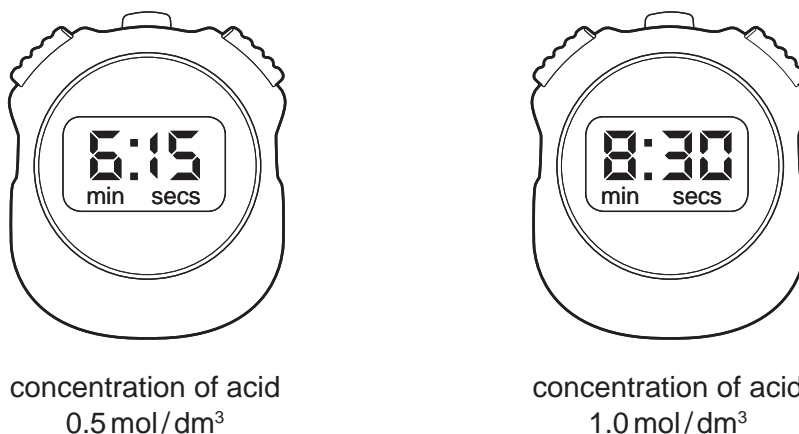

Fig. 5.1

Table 5.1

concentration of acid in mol / dm ³	0.25	0.5	1.0	2.0
time taken / s	210			960

(b) Why can the graph paper **not** be seen through the contents of the tube when the marble is reacting with acid?

.....
..... [1]

(c) The marble is in excess. What can be **seen** in the test-tube after the reaction has finished that proves this?

..... [1]

(d) (i) Plot the results on the grid below and draw a line of best fit.

For
Examiner's
Use

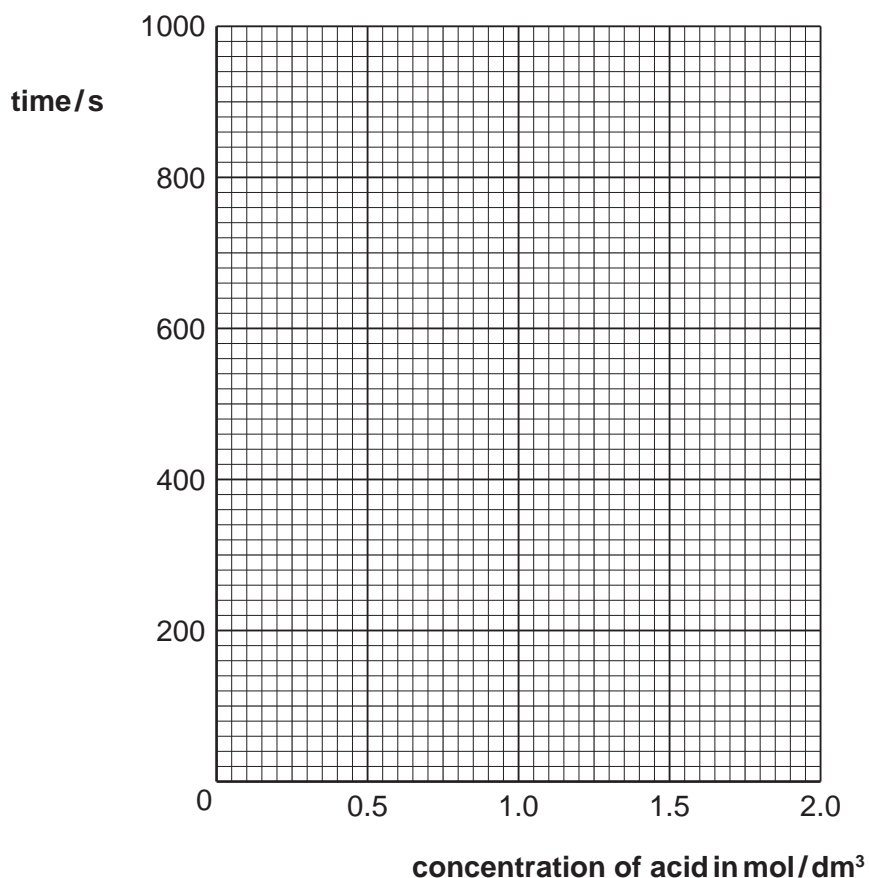

[3]

(ii) Use your graph to estimate the concentration of the acid used if the reaction finishes at 10 minutes exactly.

..... [1]

(e) Draw on the grid a line to represent a set of results produced if the temperature of the acid is increased. Label this line **T**. [1]

(f) State **one** possible source of error in the experiment in part (a).

..... [1]

- 6 A metre rule balances when it is suspended from a hook at the 50 cm mark. A toy metal dog is tied to one side, 40 cm from the balance point. A block of iron is hung on the other side so that the rule balances again, as in Fig. 6.1.

For
Examiner's
Use

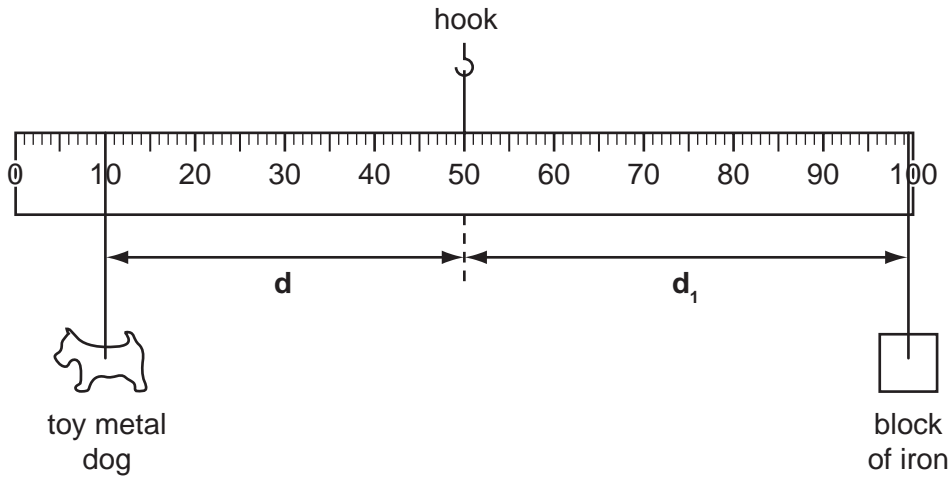

Fig. 6.1

The dog is moved to another position and the block is moved until the rule balances again. This is repeated several times and the results recorded in Table 6.1.

Table 6.1

distance of dog from hook d/cm	40.0	35.5	29.5	26.0	21.0	15.5	10.0
distance of iron from hook d_1/cm	49.5	44.5		32.5		20.0	12.5

- (a) (i) Read the rulers in Fig. 6.2 and Fig. 6.3. Calculate the distances d_1 of the block of iron from the balance point.

Record these distances in Table 6.1.

[2]

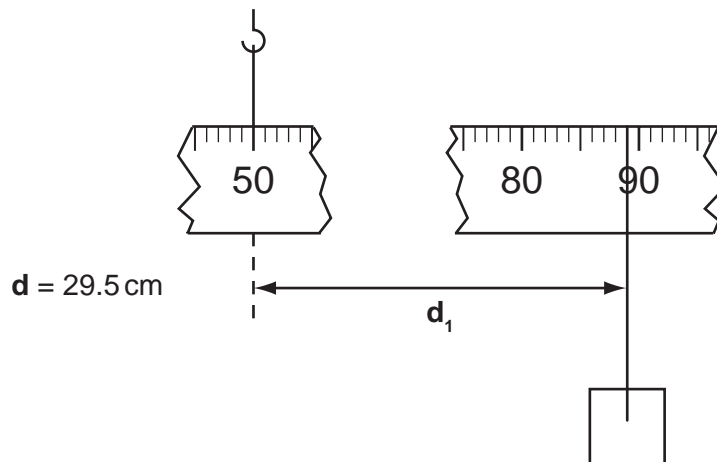

Fig. 6.2

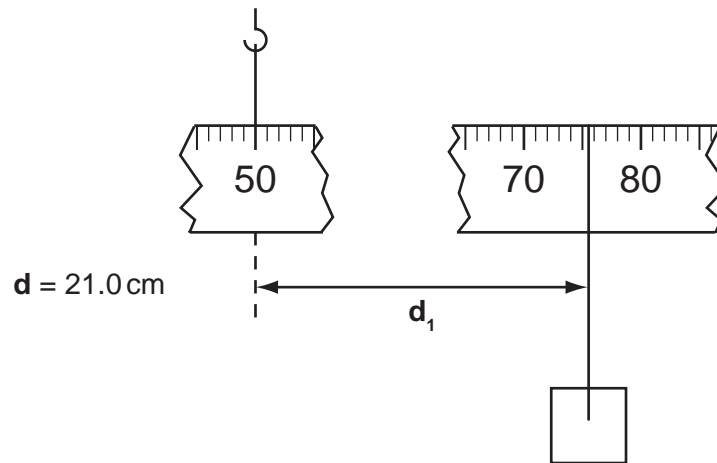

Fig. 6.3

- (ii) The experiment is repeated, but this time the toy dog is immersed in a large beaker of water, as in Fig. 6.4.

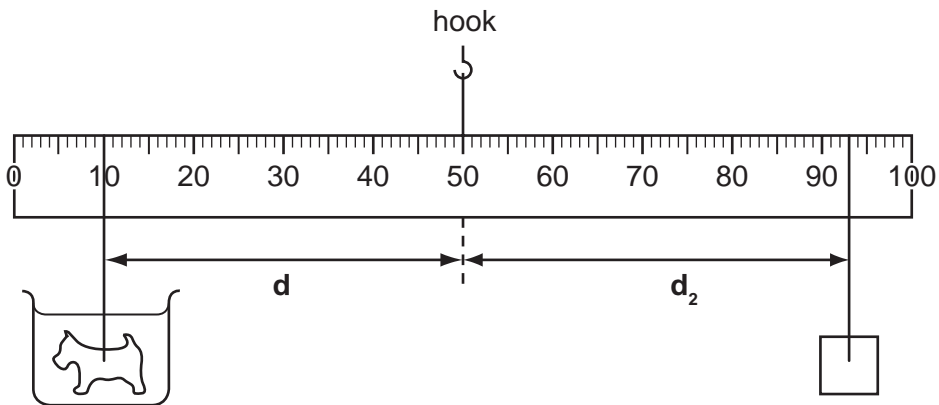

Fig. 6.4

The same values of d are used and the iron block moved to balance the rule each time.

Read the rulers in Fig. 6.5 and Fig. 6.6, then calculate the distances d_2 of the block of iron from the balance point.

For
Examiner's
Use

Record these distances in Table 6.2.

[2]

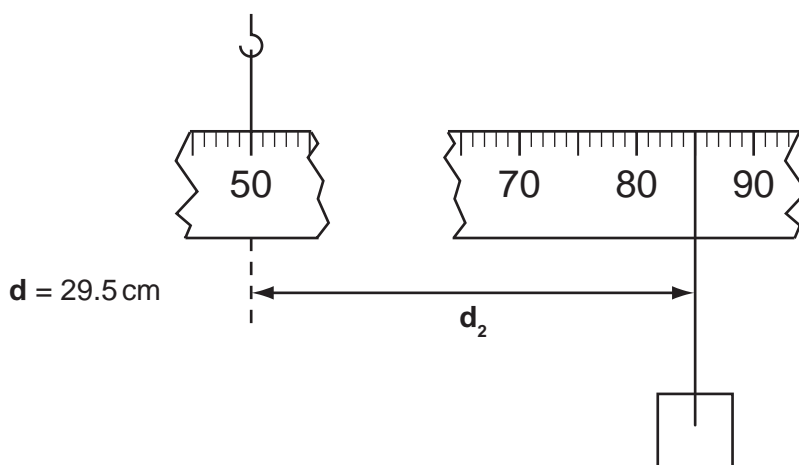

Fig. 6.5

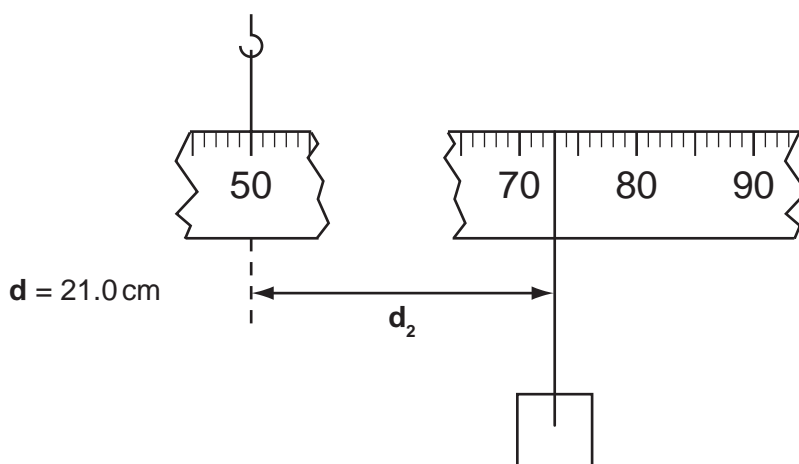

Fig. 6.6

Table 6.2

distance of dog from hook d /cm	40.0	35.5	29.5	26.0	21.0	15.5	10.0
distance of iron from hook d_2 /cm	43.0	40.5		29.5		18.0	11.5

(iii) The distances, d_2 , of the block are subtracted from the distances, d_1 .

Use data from Table 6.1 and Table 6.2 to help you complete Table 6.3.

[1]

Table 6.3

distance of dog d /cm	40.0	35.5	29.5	26.0	21.0	15.5	10.0
$(d_1 - d_2)$ /cm	6.5	4.0		3.0		2.0	1.0

(b) The results of a similar experiment were plotted in a graph, Fig. 6.7 and the line of best fit drawn.

For
Examiner's
Use

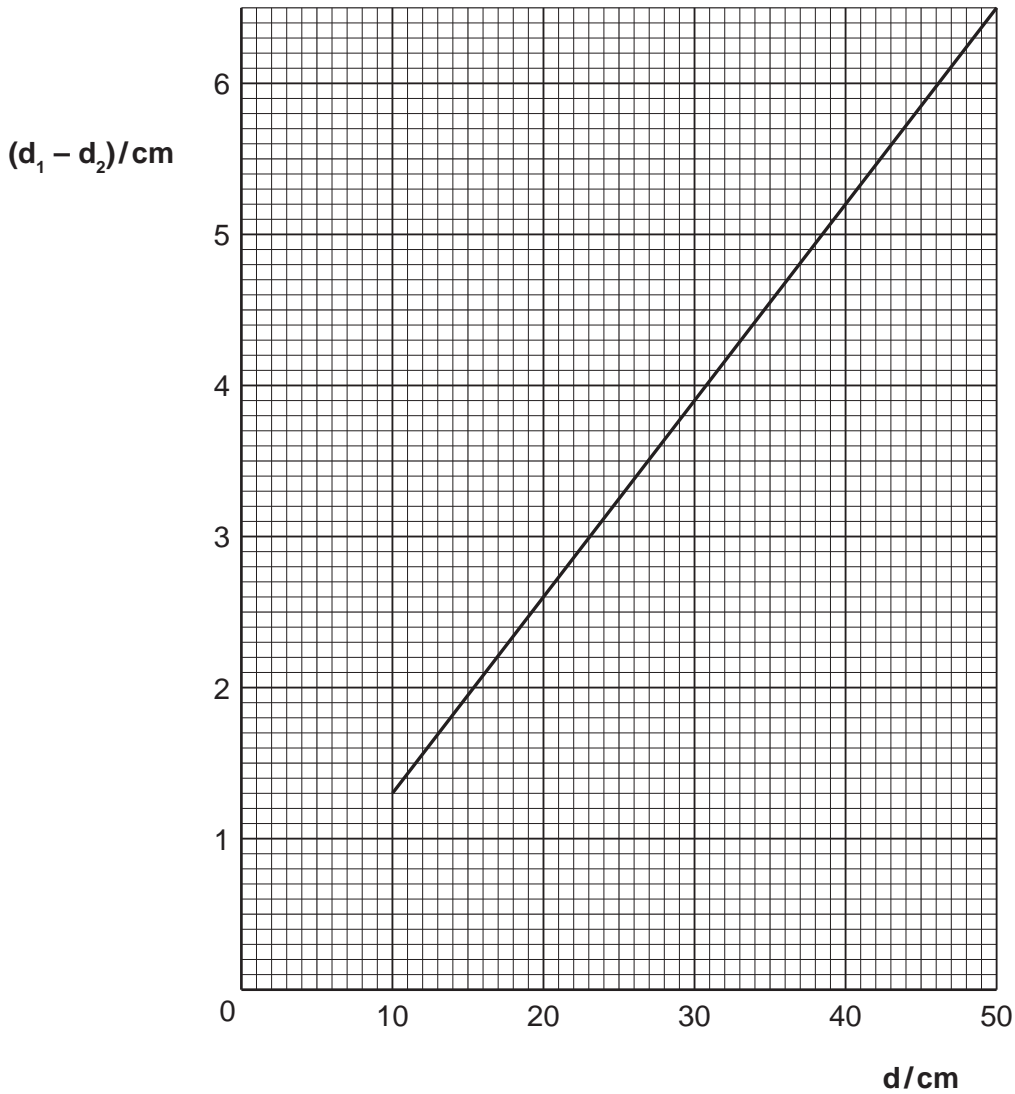

Fig. 6.7

Calculate the gradient of the line, which is equal to the density of the metal of the toy dog.

Show on the graph how you did this.

density of the metal of the toy dog = g/cm³ [2]

- (c) The density can also be found using the mass of the toy dog in grams, and its volume in cubic centimetres.

For
Examiner's
Use

Describe in detail how you would find the volume of the toy dog.

.....

.....

.....

..... [3]

Permission to reproduce items where third-party owned material protected by copyright is included has been sought and cleared where possible. Every reasonable effort has been made by the publisher (UCLES) to trace copyright holders, but if any items requiring clearance have unwittingly been included, the publisher will be pleased to make amends at the earliest possible opportunity.

University of Cambridge International Examinations is part of the Cambridge Assessment Group. Cambridge Assessment is the brand name of University of Cambridge Local Examinations Syndicate (UCLES), which is itself a department of the University of Cambridge.