



UNIVERSITY OF CAMBRIDGE INTERNATIONAL EXAMINATIONS  
International General Certificate of Secondary Education

**COMBINED SCIENCE**

**0653/13**

Paper 1 Multiple Choice

**October/November 2010**

**45 minutes**

Additional Materials: Multiple Choice Answer Sheet  
Soft clean eraser  
Soft pencil (type B or HB is recommended)



**READ THESE INSTRUCTIONS FIRST**

Write in soft pencil.

Do not use staples, paper clips, highlighters, glue or correction fluid.

Write your name, Centre number and candidate number on the Answer Sheet in the spaces provided unless this has been done for you.

There are **forty** questions on this paper. Answer **all** questions. For each question there are four possible answers **A, B, C** and **D**.

Choose the **one** you consider correct and record your choice in **soft pencil** on the separate Answer Sheet.

**Read the instructions on the Answer Sheet very carefully.**

Each correct answer will score one mark. A mark will not be deducted for a wrong answer.

Any rough working should be done in this booklet.

A copy of the Periodic Table is printed on page **20**.

This document consists of **17** printed pages and **3** blank pages.



1 Which part of a plant cell contains starch grains?

- A cell wall
- B chloroplasts
- C nucleus
- D vacuole

2 The diagram shows a section through a leaf.

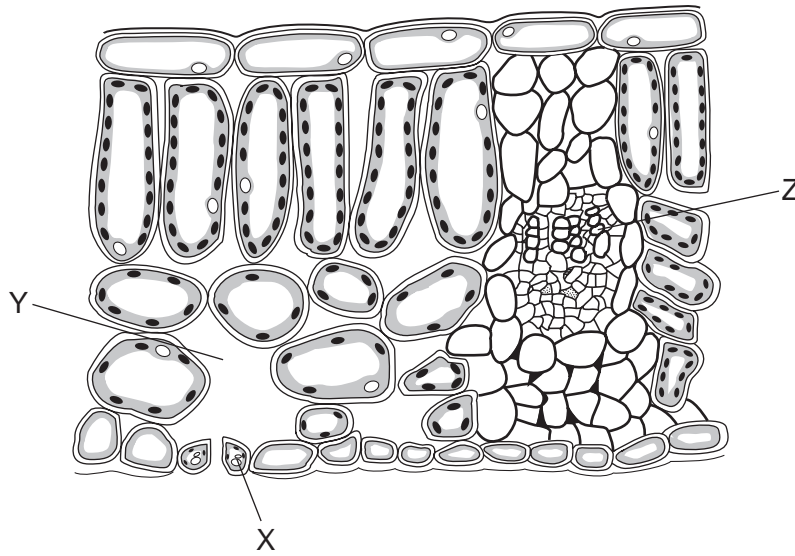

What are X, Y and Z?

	X	Y	Z
A	epidermis cell	air space	phloem
B	epidermis cell	stoma	xylem
C	guard cell	air space	xylem
D	guard cell	stoma	phloem

3 When a plant cell is placed in a dilute solution of red dye, the contents of the cell do not become red.

What prevents the dye molecules from entering the cell?

- A cell surface membrane
- B chloroplasts
- C cytoplasm
- D vacuole

4 Which is correct for all enzymes?

	made of proteins	made inside cells
<b>A</b>	✓	✓
<b>B</b>	✓	x
<b>C</b>	x	✓
<b>D</b>	x	x

5 Which blood vessel carries oxygenated blood away from the heart?

- A** aorta
- B** pulmonary artery
- C** pulmonary vein
- D** vena cava

6 The diagram shows an alveolus and one of its capillaries.

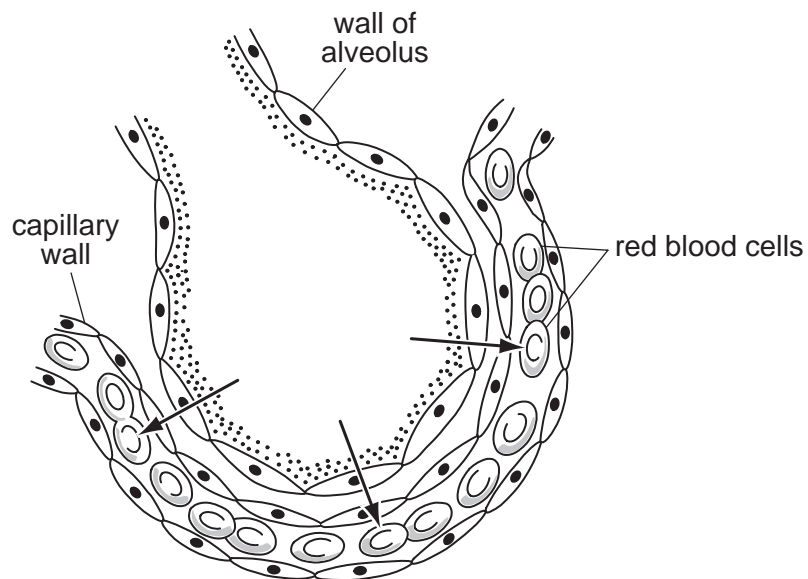

What moves in the direction shown by the arrows?

- A** carbon dioxide
- B** hydrogen
- C** oxygen
- D** water

7 The diagram shows a section through a leaf. The arrows show water movement.

Where does the water evaporate?

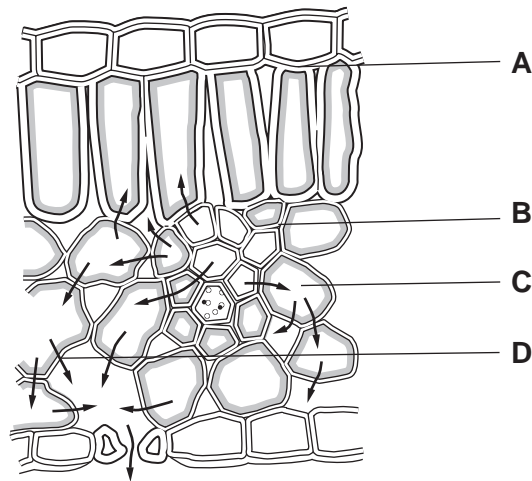

8 What is the stimulus for insulin secretion and what is the effect of insulin on the liver?

	stimulus for secretion	effect on the liver
<b>A</b>	high blood glucose	decreased glucose uptake
<b>B</b>	high blood glucose	increased glucose uptake
<b>C</b>	low blood glucose	decreased glucose uptake
<b>D</b>	low blood glucose	increased glucose uptake

9 Which nutrient, when deficient in the diet, causes a lack of haemoglobin in red blood cells?

- A** calcium
- B** iron
- C** vitamin C
- D** vitamin D

10 Which variation amongst humans is **not** affected by diet?

- A** blood group
- B** bone strength
- C** height
- D** speed of wound healing

11 The diagram shows the uterus and stages in the formation and implantation of a human embryo.

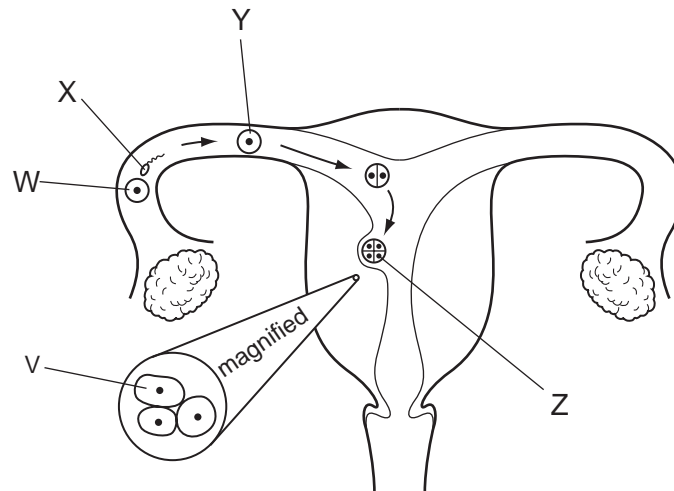

Which cells are genetically identical?

- A** W and Z      **B** X and V      **C** X and Y      **D** Y and Z

12 The table shows the names of plant reproductive structures.

Which does **not** link a structure with what it contains?

	structure	what it contains
<b>A</b>	anther	pollen grain
<b>B</b>	fruit	seed
<b>C</b>	seed	embryo
<b>D</b>	style	ovule

13 The chart shows four stages in the purification of drinking water.

Which stage sterilises the water?

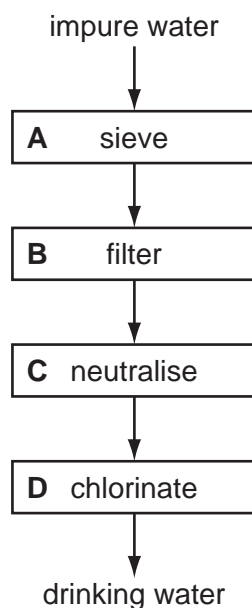

14 What will increase soil erosion?

- A deforestation
- B maintaining natural plant cover
- C reducing grazing by livestock
- D terracing of the land

15 Three students make statements about the differences between elements, compounds and mixtures.

Student 1 All elements exist only as atoms and not molecules.

Student 2 Compounds contain at least two elements.

Student 3 Mixtures consist only of compounds.

Which students are correct?

- A 1 only      B 2 only      C 3 only      D 1, 2 and 3

16 Which three elements are all transition elements?

- A chlorine, bromine and iodine
- B helium, neon and argon
- C iron, cobalt and nickel
- D lithium, sodium and potassium

17 The table shows information about four different compounds.

Which compound contains ionic bonds?

	formula of compound	elements present in compound
<b>A</b>	CO <sub>2</sub>	carbon, oxygen
<b>B</b>	HCl	hydrogen, chlorine
<b>C</b>	NH <sub>3</sub>	nitrogen, hydrogen
<b>D</b>	Na <sub>2</sub> O	sodium, oxygen

18 Aqueous copper(II) sulfate consists of copper(II) sulfate dissolved in water.

Which apparatus could **not** be used to remove water from this solution?

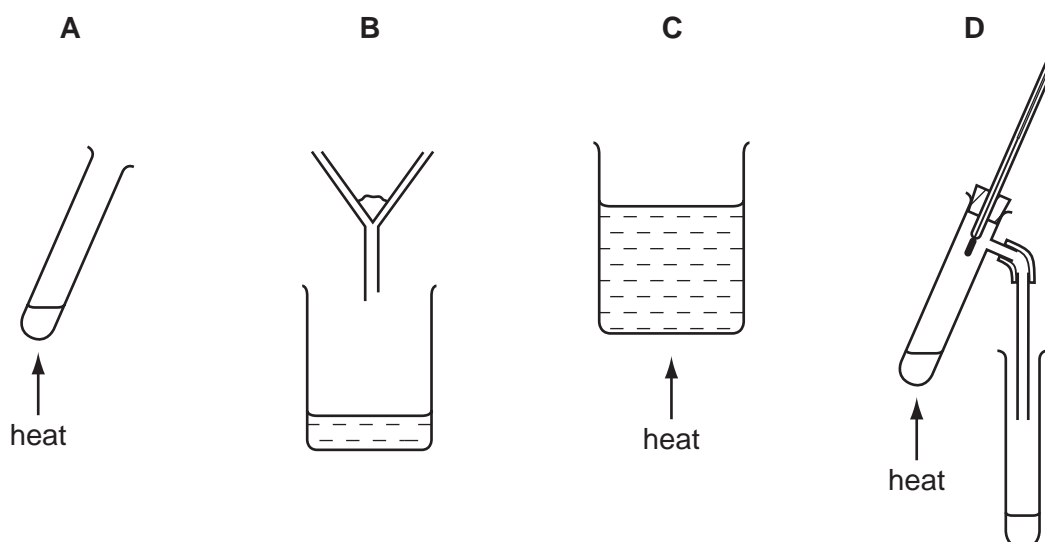

19 Aluminium occurs as aluminium oxide in the ore bauxite.

Which terms apply to the extraction of aluminium from aluminium oxide?

	electrolysis	reduction
<b>A</b>	✓	✓
<b>B</b>	✓	x
<b>C</b>	x	✓
<b>D</b>	x	x

20 The equation represents the reaction of aluminium with sulfuric acid.

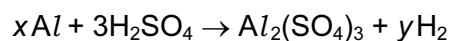

What are the correct values of  $x$  and  $y$ ?

	$x$	$y$
<b>A</b>	2	3
<b>B</b>	2	6
<b>C</b>	3	3
<b>D</b>	3	6

21 An electrolysis circuit is set up using carbon electrodes as shown.

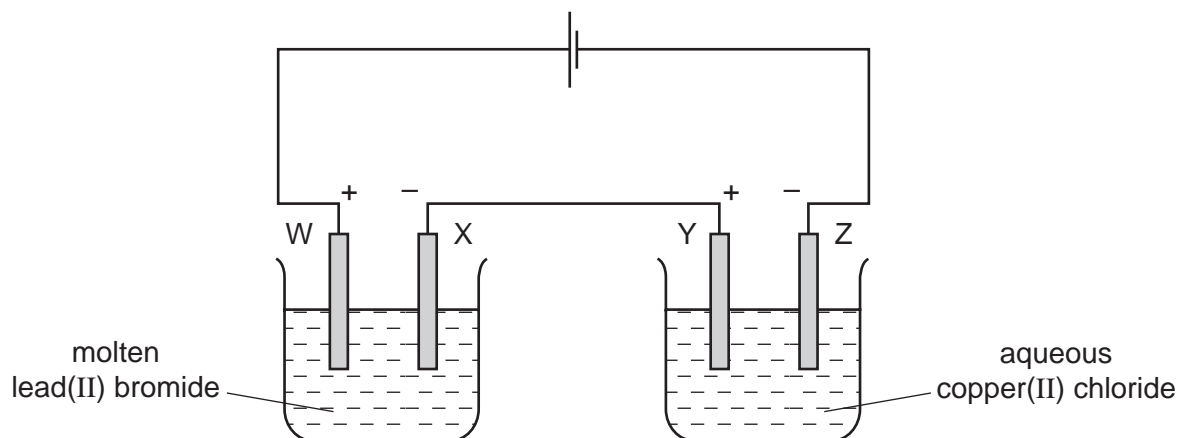

At which two electrodes would a Group VII element be formed?

- A** W and Y      **B** W and Z      **C** X and Y      **D** X and Z



22 Aqueous copper(II) ions,  $\text{Cu}^{2+}(\text{aq})$ , are blue.

In separate experiments, X and Y, copper powder is added to a test-tube of liquid and the mixture stirred. At the end of each experiment some copper powder remains at the bottom of each tube.

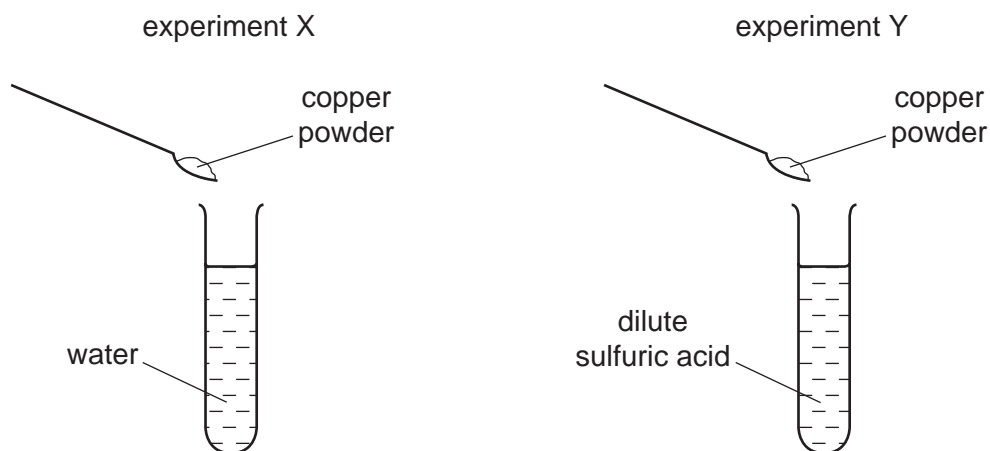

What are the final colours of the liquids above the copper powder?

	experiment X	experiment Y
<b>A</b>	blue	blue
<b>B</b>	blue	colourless
<b>C</b>	colourless	blue
<b>D</b>	colourless	colourless

23 A 250 g portion of potatoes is to be cooked in boiling water.

Which form of the potatoes will require the shortest cooking time?

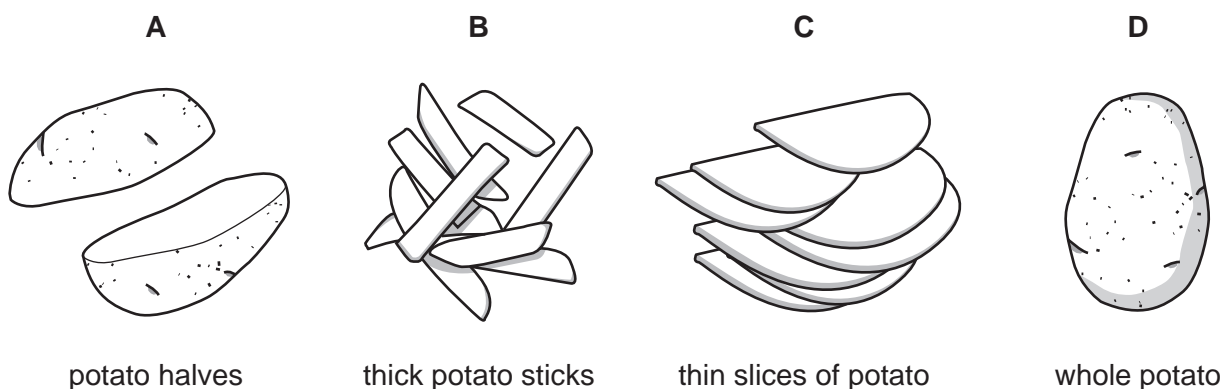

24 The equations for two reactions are shown.

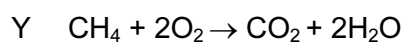
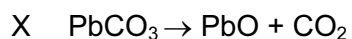

Which types of reaction are X and Y?

	X	Y
<b>A</b>	combustion	neutralisation
<b>B</b>	combustion	thermal decomposition
<b>C</b>	thermal decomposition	combustion
<b>D</b>	thermal decomposition	neutralisation

25 Two products, X and Y, are formed in the complete combustion of methane.

What are X and Y?

- A** carbon and hydrogen
- B** carbon and water
- C** carbon dioxide and hydrogen
- D** carbon dioxide and water

26 Which structure shows a polymer that is also a hydrocarbon?

**A**

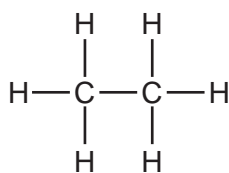

**B**

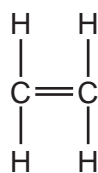

**C**

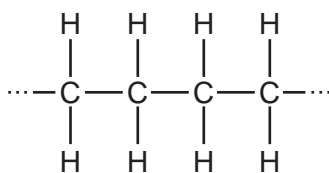

**D**

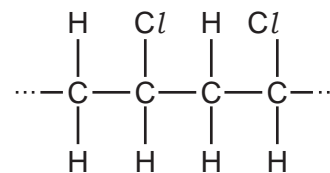

27 Crude oil (petroleum) is heated, using the apparatus shown.

Four fractions, with different boiling point ranges, are collected.

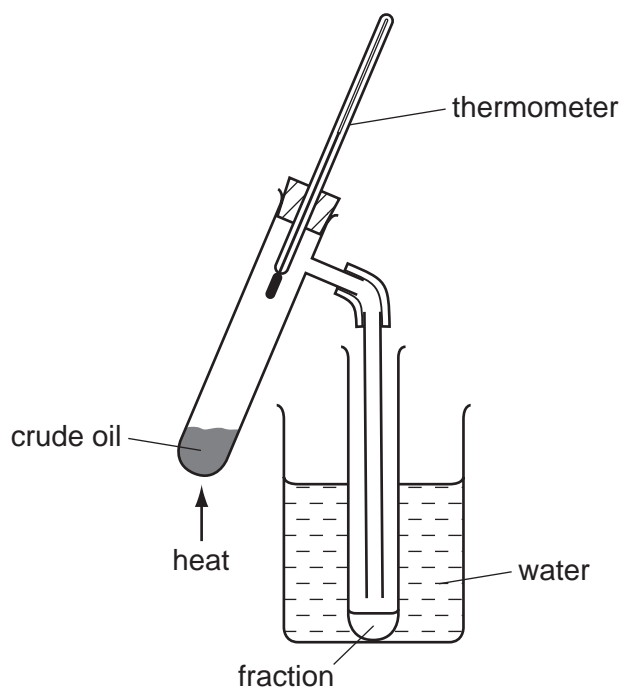

Which term best describes crude oil?

- A a compound
- B an element
- C a mixture
- D a plastic

28 Which statement is correct?

- A The mass of a bottle of water at the North Pole is different from its mass at the Equator.
- B The mass of a bottle of water is measured in newtons.
- C The weight of a bottle of water and its mass are both measured in kilograms.
- D The weight of a bottle of water is one of the forces acting on the bottle.

- 29 A ruler and a block of wood are used to find the diameter of some identical metal balls.

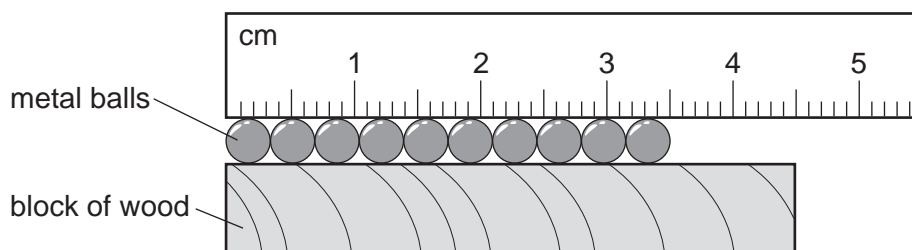

What is the diameter of a single ball?

- A 3.5 mm      B 4.5 mm      C 3.5 cm      D 4.5 cm
- 30 Which substance in the table has the lowest density?

	substance	mass / g	volume / cm <sup>3</sup>
A	nylon	1.2	1.0
B	cotton	1.5	1.0
C	olive oil	1.8	2.0
D	water	2.0	2.0

- 31 In a hydroelectric power station, one form of energy is stored in a reservoir. This energy is then transferred in stages to another form, which is the output.

Which row gives the names for the stored energy and the output energy?

	stored energy	output energy
A	electrical	heat
B	electrical	kinetic
C	kinetic	electrical
D	potential	electrical

32 The graph shows how the speed of an object changes over an interval of time.

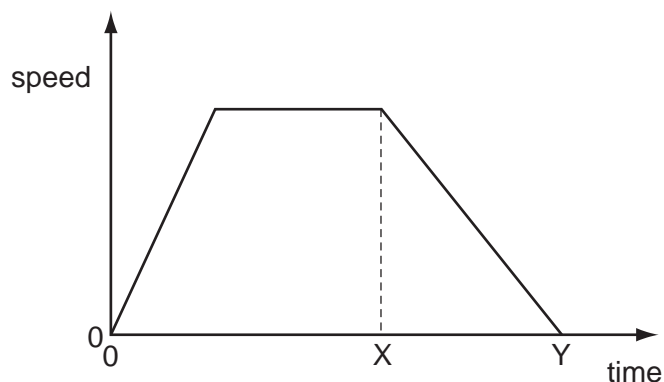

Which statement describes the acceleration of the object between time X and time Y?

- A It is constant.
- B It is decreasing.
- C It is increasing.
- D It is zero.

33 A camper sits beside a fire and quickly begins to feel warm. He pushes the end of a metal rod into the fire and after a while his hand feels the rod getting warm.

Which heat transfers are taking place?

	heat transfer from fire through the air	heat transfer from fire through the rod
<b>A</b>	conduction	convection
<b>B</b>	conduction	radiation
<b>C</b>	radiation	conduction
<b>D</b>	radiation	convection

34 The diagram shows an electrical circuit.

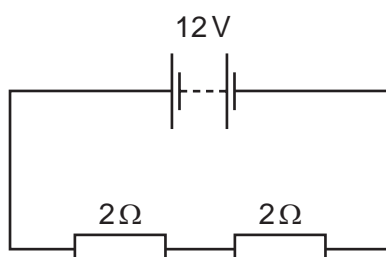

What is the current through the circuit?

- A** 3A
- B** 4A
- C** 12A
- D** 24A

- 35 The diagrams show part of an electric circuit containing an ammeter and a voltmeter.

Which arrangement should be used to measure the potential difference (p.d.) across the resistor and the current through it?

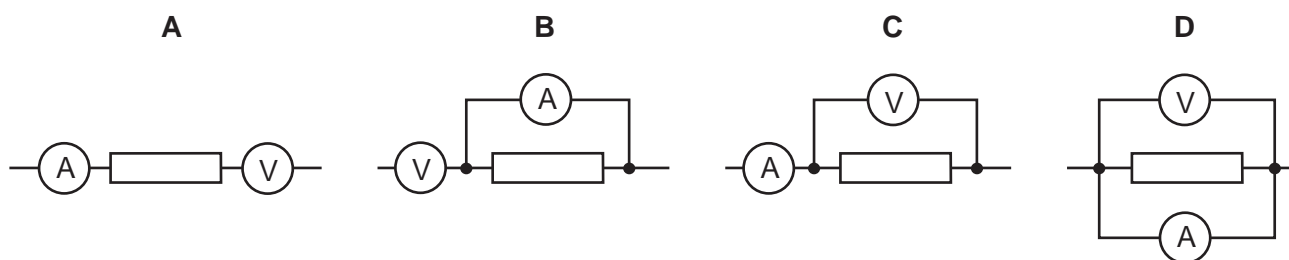

- 36 In the circuit shown, only one of the fuses has blown, but none of the lamps is lit.

Which fuse has blown?

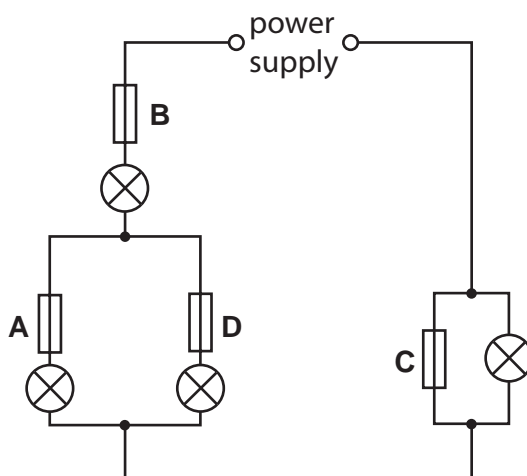

- 37 A police car with its siren sounding is stationary in heavy traffic. A pedestrian notices that, although the loudness of the sound produced does not change, the pitch varies.

Which row in the table describes the amplitude and the frequency of the sound?

	amplitude	frequency
<b>A</b>	constant	constant
<b>B</b>	constant	varying
<b>C</b>	varying	constant
<b>D</b>	varying	varying

38 The Sun heats the Earth by electromagnetic radiation.

Which region of the electromagnetic spectrum is responsible for most of this heating?

- A microwave
- B infra-red
- C ultraviolet
- D X-ray

39 A source of light is placed at the focus  $F$  of a converging lens. The focal length of the lens is  $f$ .

Which diagram shows the path of the rays of light that pass through the lens?

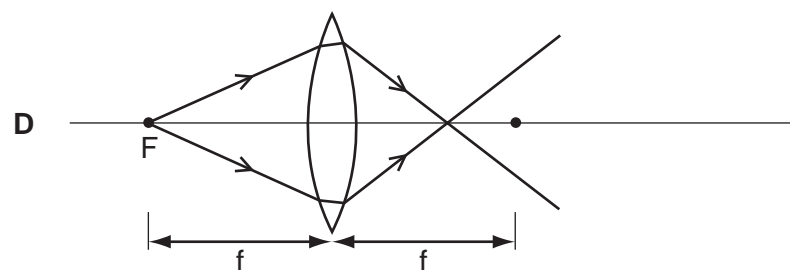
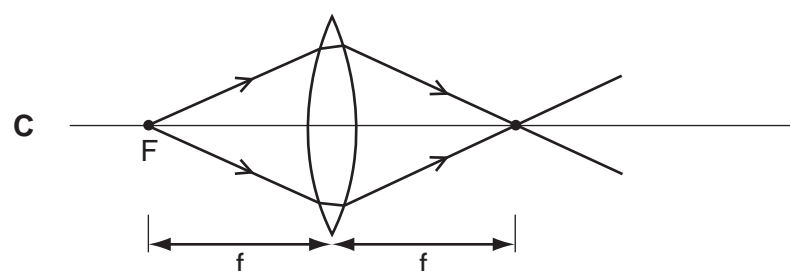
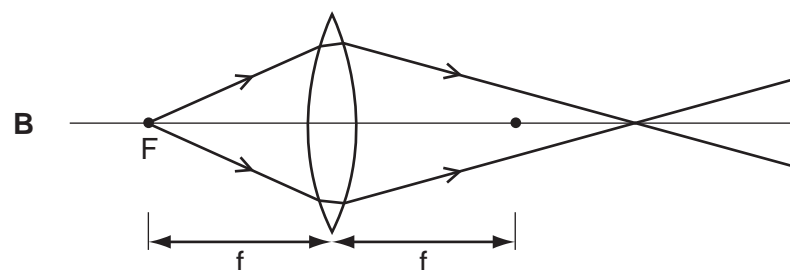
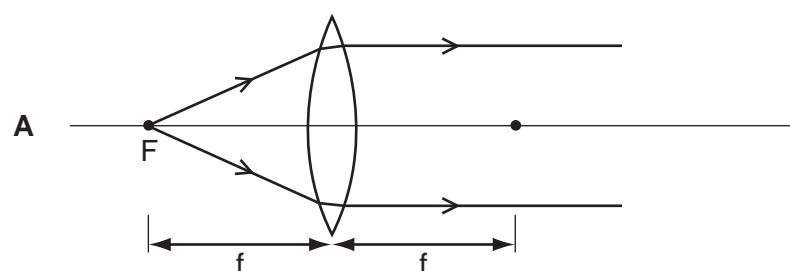

40 Which row in the table describes alpha-particles?

	electric charge	penetrates 1 cm of aluminium?
<b>A</b>	negative	yes
<b>B</b>	negative	no
<b>C</b>	positive	yes
<b>D</b>	positive	no









**DATA SHEET**  
**The Periodic Table of the Elements**

		Group																																																																																																																																																																																																																																																																																																																																																																																																																																																																																																																																																																																																																																																																																																																																																																																																																																																																																																																																																
		I	II	III	IV	V	VI	VII	VIII	IX	X																																																																																																																																																																																																																																																																																																																																																																																																																																																																																																																																																																																																																																																																																																																																																																																																																																																																																																																																							
		1 <b>H</b> Hydrogen 1																																																																																																																																																																																																																																																																																																																																																																																																																																																																																																																																																																																																																																																																																																																																																																																																																																																																																																																																																
		4 <b>He</b> Helium 2																																																																																																																																																																																																																																																																																																																																																																																																																																																																																																																																																																																																																																																																																																																																																																																																																																																																																																																																																
7	9	3	4	5	6	7	8	9	10	11	12	13	14	15	16	17	18	19	20																																																																																																																																																																																																																																																																																																																																																																																																																																																																																																																																																																																																																																																																																																																																																																																																																																																																																																																															
<b>Li</b> Lithium	<b>Be</b> Beryllium	<b>B</b> Boron	<b>C</b> Carbon	<b>N</b> Nitrogen	<b>O</b> Oxygen	<b>F</b> Fluorine	<b>Ne</b> Neon	<b>Na</b> Sodium	<b>Mg</b> Magnesium	<b>Al</b> Aluminium	<b>Si</b> Silicon	<b>P</b> Phosphorus	<b>S</b> Sulfur	<b>Cl</b> Chlorine	<b>Ar</b> Argon	<b>K</b> Potassium	<b>Ca</b> Calcium	<b>Sc</b> Scandium	<b>Ti</b> Titanium	<b>V</b> Vanadium	<b>Cr</b> Chromium	<b>Mn</b> Manganese	<b>Fe</b> Iron	<b>Co</b> Cobalt	<b>Ni</b> Nickel	<b>Cu</b> Copper	<b>Zn</b> Zinc	<b>Ga</b> Gallium	<b>Ge</b> Germanium	<b>As</b> Arsenic	<b>Se</b> Selenium	<b>Br</b> Bromine	<b>Kr</b> Krypton																																																																																																																																																																																																																																																																																																																																																																																																																																																																																																																																																																																																																																																																																																																																																																																																																																																																																																																	
19	37	38	39	40	41	42	43	44	45	46	47	48	49	50	51	52	53	54	55	56	57	58	59	60	61	62	63	64	65	66	67	68	69	70	71	72	73	74	75	76	77	78	79	80	81	82	83	84	85	86																																																																																																																																																																																																																																																																																																																																																																																																																																																																																																																																																																																																																																																																																																																																																																																																																																																																																																
<b>Rb</b> Rubidium	<b>Sr</b> Strontium	<b>Y</b> Yttrium	<b>Zr</b> Zirconium	<b>Nb</b> Niobium	<b>Mo</b> Molybdenum	<b>Tc</b> Technetium	<b>Ru</b> Ruthenium	<b>Rh</b> Rhodium	<b>Pd</b> Palladium	<b>Ag</b> Silver	<b>Cd</b> Cadmium	<b>In</b> Indium	<b>Sn</b> Tin	<b>Sb</b> Antimony	<b>Te</b> Tellurium	<b>I</b> Iodine	<b>Xe</b> Xenon	<b>Cs</b> Caesium	<b>Ba</b> Barium	<b>La</b> Lanthanum	<b>Ce</b> Cerium	<b>Pr</b> Praseodymium	<b>Nd</b> Neodymium	<b>Pm</b> Promethium	<b>Sm</b> Samarium	<b>Eu</b> Europium	<b>Gd</b> Gadolinium	<b>Tb</b> Terbium	<b>Dy</b> Dysprosium	<b>Ho</b> Holmium	<b>Er</b> Erbium	<b>Tm</b> Thulium	<b>Yb</b> Ytterbium	<b>Lu</b> Lutetium	<b>Fr</b> Francium	<b>Ra</b> Radium	<b>Ac</b> Actinium	<b>Th</b> Thorium	<b>Pa</b> Protactinium	<b>U</b> Uranium	<b>Np</b> Neptunium	<b>Pu</b> Plutonium	<b>Am</b> Americium	<b>Cm</b> Curium	<b>Bk</b> Berkelium	<b>Cf</b> Californium	<b>Es</b> Einsteinium	<b>Fm</b> Fermium	<b>Md</b> Mendelevium	<b>No</b> Nobelium	<b>Lr</b> Lawrencium																																																																																																																																																																																																																																																																																																																																																																																																																																																																																																																																																																																																																																																																																																																																																																																																																																																																																															
55	87	88	89	90	91	92	93	94	95	96	97	98	99	100	101	102	103	104	105	106	107	108	109	110	111	112	113	114	115	116	117	118	119	120	121	122	123	124	125	126	127	128	129	130	131	132	133	134	135	136	137	138	139	140	141	142	143	144	145	146	147	148	149	150	151	152	153	154	155	156	157	158	159	160	161	162	163	164	165	166	167	168	169	170	171	172	173	174	175	176	177	178	179	180	181	182	183	184	185	186	187	188	189	190	191	192	193	194	195	196	197	198	199	200	201	202	203	204	205	206	207	208	209	210	211	212	213	214	215	216	217	218	219	220	221	222	223	224	225	226	227	228	229	230	231	232	233	234	235	236	237	238	239	240	241	242	243	244	245	246	247	248	249	250	251	252	253	254	255	256	257	258	259	260	261	262	263	264	265	266	267	268	269	270	271	272	273	274	275	276	277	278	279	280	281	282	283	284	285	286	287	288	289	290	291	292	293	294	295	296	297	298	299	300	301	302	303	304	305	306	307	308	309	310	311	312	313	314	315	316	317	318	319	320	321	322	323	324	325	326	327	328	329	330	331	332	333	334	335	336	337	338	339	340	341	342	343	344	345	346	347	348	349	350	351	352	353	354	355	356	357	358	359	360	361	362	363	364	365	366	367	368	369	370	371	372	373	374	375	376	377	378	379	380	381	382	383	384	385	386	387	388	389	390	391	392	393	394	395	396	397	398	399	400	401	402	403	404	405	406	407	408	409	410	411	412	413	414	415	416	417	418	419	420	421	422	423	424	425	426	427	428	429	430	431	432	433	434	435	436	437	438	439	440	441	442	443	444	445	446	447	448	449	450	451	452	453	454	455	456	457	458	459	460	461	462	463	464	465	466	467	468	469	470	471	472	473	474	475	476	477	478	479	480	481	482	483	484	485	486	487	488	489	490	491	492	493	494	495	496	497	498	499	500	501	502	503	504	505	506	507	508	509	510	511	512	513	514	515	516	517	518	519	520	521	522	523	524	525	526	527	528	529	530	531	532	533	534	535	536	537	538	539	540	541	542	543	544	545	546	547	548	549	550	551	552	553	554	555	556	557	558	559	560	561	562	563	564	565	566	567	568	569	570	571	572	573	574	575	576	577	578	579	580	581	582	583	584	585	586	587	588	589	590	591	592	593	594	595	596	597	598	599	600	601	602	603	604	605	606	607	608	609	610	611	612	613	614	615	616	617	618	619	620	621	622	623	624	625	626	627	628	629	630	631	632	633	634	635	636	637	638	639	640	641	642	643	644	645	646	647	648	649	650	651	652	653	654	655	656	657	658	659	660	661	662	663	664	665	666	667	668	669	670	671	672	673	674	675	676	677	678	679	680	681	682	683	684	685	686	687	688	689	690	691	692	693	694	695	696	697	698	699	700	701	702	703	704	705	706	707	708	709	710	711	712	713	714	715	716	717	718	719	720	721	722	723	724	725	726	727	728	729	730	731	732	733	734	735	736	737	738	739	740	741	742	743	744	745	746	747	748	749	750	751	752	753	754	755	756	757	758	759	760	761	762	763	764	765	766	767	768	769	770	771	772	773	774	775	776	777	778	779	780	781	782	783	784	785	786	787	788	789	790	791	792	793	794	795	796	797	798	799	800	801	802	803	804	805	806	807	808	809	810	811	812	813	814	815	816	817	818	819	820	821	822	823	824	825	826	827	828	829	830	831	832	833	834	835	836	837	838	839	840	841	842	843	844	845	846	847	848	849	850	851	852	853	854	855	856	857	858	859	860	861	862	863	864	865	866	867	868	869	870	871	872	873	874	875	876	877	878	879	880	881	882	883	884	885	886	887	888	889	890	891	892	893	894	895	896	897	898	899	900	901	902	903	904	905	906	907	908	909	910	911	912	913	914	915	916	917	918	919	920	921	922	923	924	925	926	927	928	929	930	931	932	933	934	935	936	937	938	939	940	941	942	943	944	945	946	947	948	949	950	951	952	953	954	955	956	957	958	959	960	961	962	963	964	965	966	967	968	969	970	971	972	973	974	975	976	977	978	979	980	981	982	983	984	985	986	987	988	989	990	991	992	993	994	995	996	997	998	999	1000

\*58-71 Lanthanoid series  
†90-103 Actinoid series

Key  

a	<b>X</b>
b	

  
 a = relative atomic mass  
 X = atomic symbol  
 b = proton (atomic) number

The volume of one mole of any gas is 24 dm<sup>3</sup> at room temperature and pressure (r.t.p.).

Permission to reproduce items where third-party owned material protected by copyright is included has been sought and cleared where possible. Every reasonable effort has been made by the publisher (UCLES) to trace copyright holders, but if any items requiring clearance have unwittingly been included, the publisher will be pleased to make amends at the earliest possible opportunity.

University of Cambridge International Examinations is part of the Cambridge Assessment Group. Cambridge Assessment is the brand name of University of Cambridge Local Examinations Syndicate (UCLES), which is itself a department of the University of Cambridge.