



UNIVERSITY OF CAMBRIDGE INTERNATIONAL EXAMINATIONS
International General Certificate of Secondary Education

CANDIDATE
NAME

CENTRE
NUMBER

--	--	--	--	--

CANDIDATE
NUMBER

--	--	--	--	--

* 6 3 0 1 3 2 9 2 7 7 *

COMBINED SCIENCE

0653/61

Paper 6 Alternative to Practical

May/June 2013

1 hour

Candidates answer on the Question paper.

No Additional Materials are required.

READ THESE INSTRUCTIONS FIRST

Write your Centre number, candidate number and name on all the work you hand in.

Write in dark blue or black pen.

You may use a soft pencil for any diagrams or graphs.

Do not use staples, paper clips, glue or correction fluid.

DO NOT WRITE IN ANY BARCODES.

Answer **all** questions.

Electronic calculators may be used.

You may lose marks if you do not show your working or if you do not use appropriate units.

At the end of the examination, fasten all your work securely together.

The number of marks is given in brackets [] at the end of each question or part question.

For Examiner's Use	
1	
2	
3	
4	
5	
6	
Total	

This document consists of **20** printed pages.



- 1 (a) Fig. 1.1 shows a flower seen in longitudinal section.



Fig. 1.1

- (i) Make a large, clear pencil drawing of this flower, in the space below.

[2]

- (ii) On your drawing, label a stamen and the carpel. Next to each of these labels, state (in brackets) whether the part is male or female. [2]

- (b) A student took a petal of a different flower and tested it for the presence of reducing sugar, using Benedict's test.

For
Examiner's
Use

Fig. 1.2 shows the appearance of the petal before and after carrying out the Benedict's test.

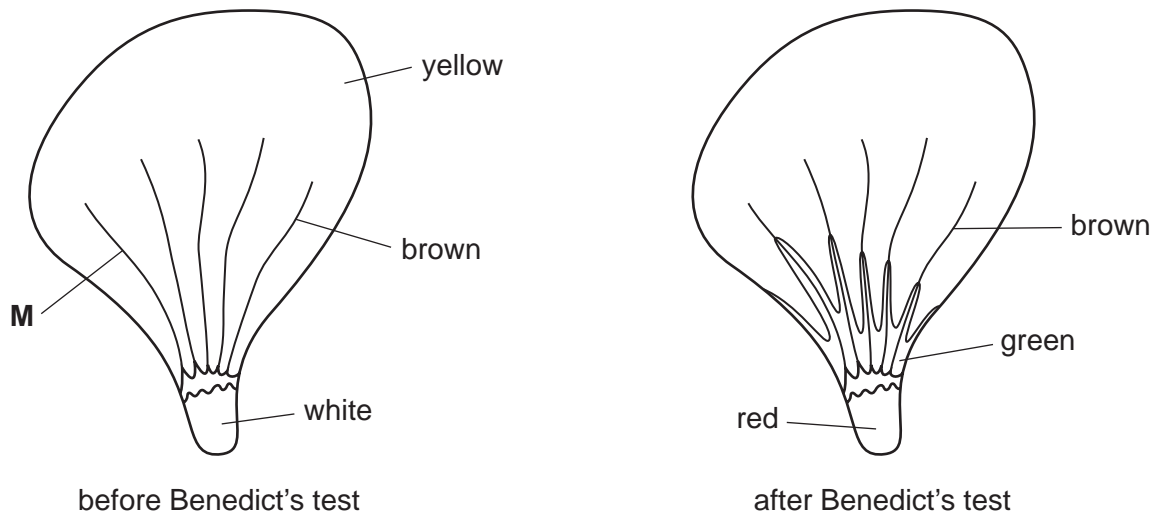

Fig. 1.2

- (i) Describe how you would carry out the Benedict's test.

.....
..... [1]

- (ii) State the function of the petals of this flower.

.....
..... [1]

- (iii) Suggest how the following features help the function of the flower,
the colour of the petal, before carrying out the Benedict's test,

.....
.....

the lines and markings, labelled **M**.

.....
..... [2]

(iv) State your conclusion from the results of the Benedict's test. Explain the significance of this in relation to your answers to (ii) and (iii).

*For
Examiner's
Use*

conclusion

.....

significance

..... [2]

- 2 (a) A student is making a fruit battery. She makes two small cuts in an orange and pushes a small piece of copper into one of the cuts, and a length of magnesium ribbon into the other as in Fig. 2.1.

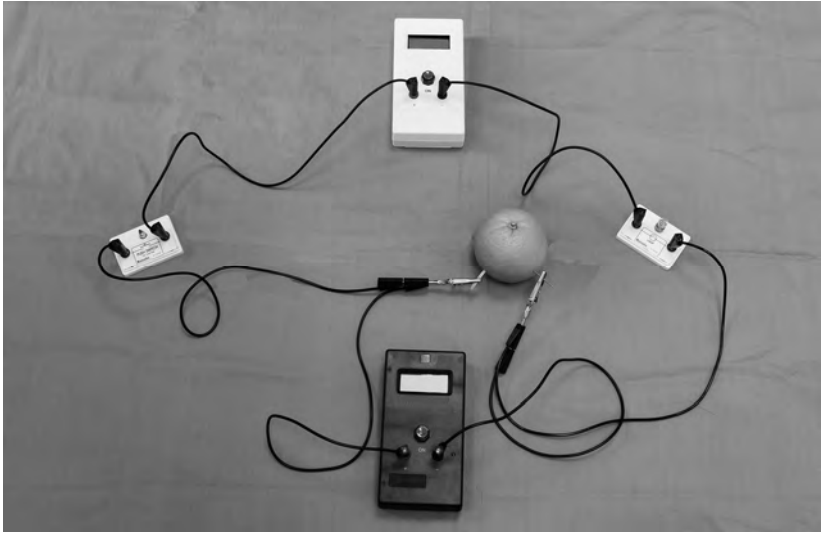

Fig. 2.1

- (i) Using a ruler, draw a circuit diagram to show the apparatus used in Fig. 2.1. Use the correct symbols to draw your diagram and label the meters.

[3]

- (ii) She notices that when the switch is closed a current flows through the circuit. Give **two** observations that would prove a current is flowing.

.....

..... [1]

- (iii) When the electrodes are magnesium and copper the reading on the voltmeter is 1.80 V.

She removes the copper electrode and replaces it with a piece of aluminium. The reading changes to 1.26 V.

She keeps the magnesium electrode and replaces the aluminium first with iron and then with lead.

Read and record the values shown on the voltmeters in Fig. 2.2 in the space provided.

For
Examiner's
Use

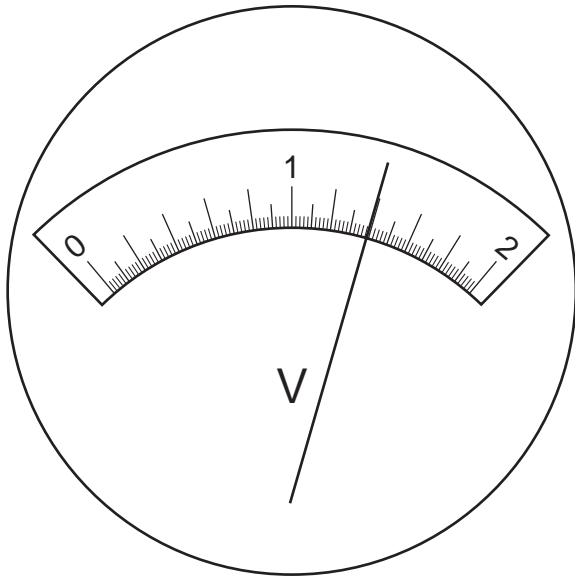

electrodes: magnesium
and iron

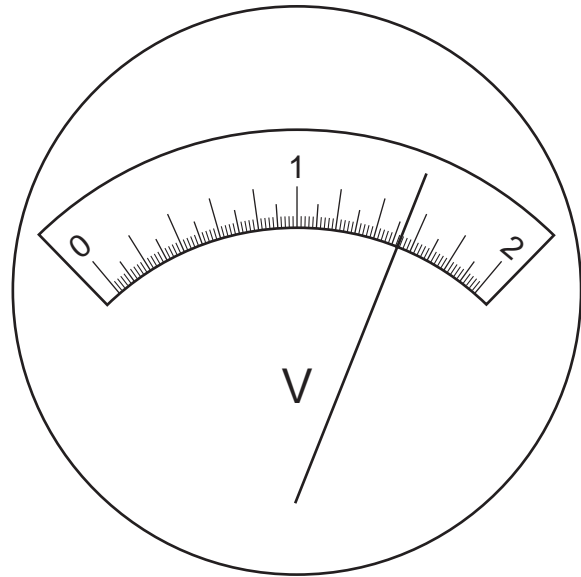

electrodes: magnesium
and lead

Fig. 2.2

..... V

..... V [2]

(b) Use the information given in (a)(iii) and your answer to (a)(iii) to construct a table showing the voltages produced with the four sets of electrodes.

For
Examiner's
Use

[2]

(c) The teacher tells the student that the order of reactivity of all the metals used in the experiment can be deduced using the information from the table.

Explain how this is possible, and list the metals in order of reactivity.

explanation

.....

order of reactivity

.....

most reactive

least reactive

[2]

- 3 A student is investigating how the concentration of a reactant affects the rate of a reaction.

For
Examiner's
Use

In this reaction potassium iodate reacts with a reducing agent to produce iodine. The reaction can be followed using starch solution as an indicator; it turns blue-black when iodine is present.

- (a)
- She places 10 cm^3 potassium iodate solution into a conical flask.
 - She adds 5 cm^3 starch solution to the conical flask.
 - She starts the timer as she adds 5 cm^3 of the reducing agent to the conical flask.
 - She stops the timer when the mixture goes blue-black.
 - She records the time taken, to the nearest second, for the mixture to go blue-black in Table 3.1.
 - She repeats the experiment four more times varying the volumes of potassium iodate solution and water as shown in Table 3.1.

Table 3.1

volume potassium iodate solution / cm^3	volume water / cm^3	time / s	$\frac{1}{\text{time}}$
10	0	10	0.100
8	2	13	0.077
6	4		
4	6	30	0.033
2	8		

Read the stop clocks in Fig. 3.1 and record the times to the nearest second in Table 3.1.

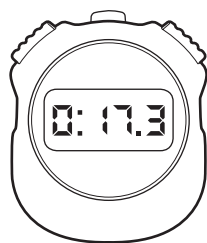

6 cm^3 potassium iodate solution



2 cm^3 potassium iodate solution

Fig. 3.1

[2]

- (b) (i) Calculate $\frac{1}{\text{time}}$ (rate) for the missing values and enter the results in the last column of Table 3.1.

[1]

- (ii) Plot a graph of $\frac{1}{\text{time}}$ (vertical axis) against the volume of potassium iodate solution / cm^3 drawing the best straight line through the origin.

For
Examiner's
Use

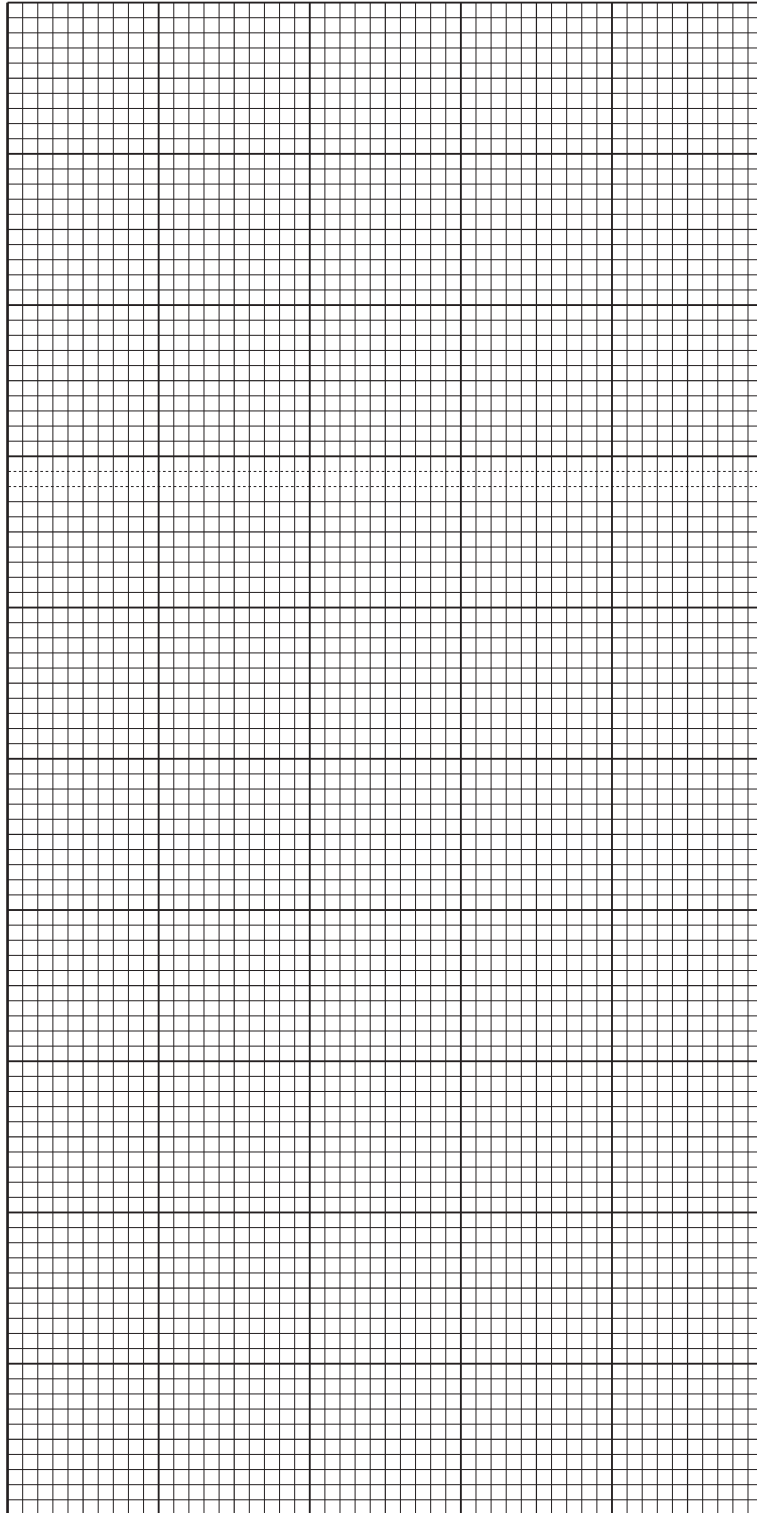

[4]

(c) (i) State what your graph tells you about how the rate of the reaction depends upon the volume of potassium iodate solution present.

.....
..... [1]

(ii) When the potassium iodate is reduced iodine is formed. What observation made by the student confirms this?

.....
..... [1]

(iii) Why are different volumes of water used in each experiment?

.....
..... [1]

Please turn over for Question 4.

- 4 The enzyme pectinase is used in the production of fruit juices. It speeds the breakdown of the walls of plant cells. This helps to release juice from the cells.

For
Examiner's
Use

A student did an experiment in which she investigated the action of pectinase on apples. She wanted to find the optimum pH for the enzyme. This value would produce the greatest volume of fruit juice.

- The student made up solutions of enzyme at different pH values.
- She prepared small cubes of apple, all the same size, and placed equal masses of cubes into five dishes.
- She added 1 cm³ pectinase solution to the dishes of apple so that each dish contained pectinase at a different pH.
- She thoroughly mixed the enzyme and apple in each dish.
- After 10 minutes the contents of each dish were filtered.

The filtrate was the juice from the apples. It dripped into the measuring cylinder. The volume of juice produced was a measure of how reactive the enzyme was.

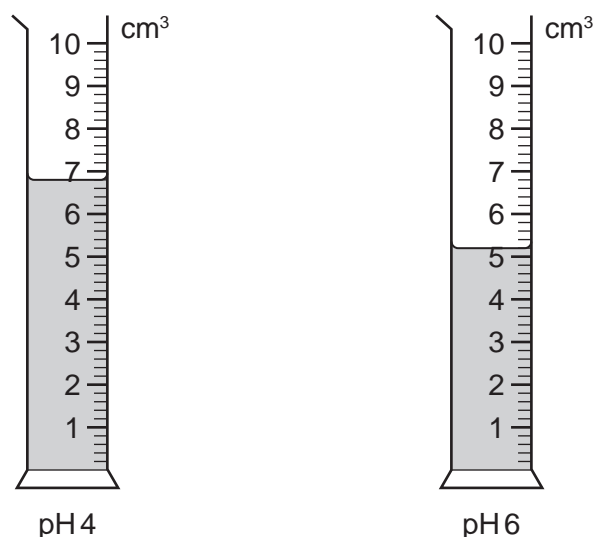

Fig. 4.1

- (a) (i) Read the scales of the measuring cylinders in Fig. 4.1 and enter the missing volumes of juice for pH values 4 and 6 in Table 4.1. [2]

Table 4.1

pH of enzyme solution	volume of juice produced / cm ³
3	4.6
4	
5	9.6
6	
7	2.2

(ii) Plot a graph of volume of juice produced/cm³ against pH of enzyme solution on the grid provided. Draw the best curve.

For
Examiner's
Use

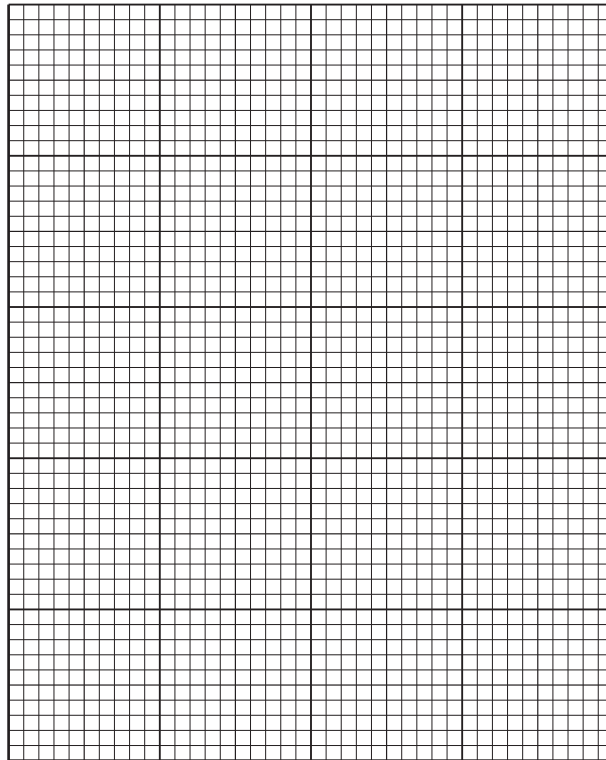

[3]

(iii) Suggest the optimum pH for the enzyme.

optimum pH = [1]

(iv) Explain why you cannot be sure of the exact optimum pH value.

.....
..... [1]

(b) Describe a control experiment the student could do to prove that the enzyme was responsible for the production of fruit juice.

.....
..... [1]

(c) Use your knowledge of the activity of enzymes to suggest **one** different method of increasing the activity of the enzyme.

Explain why it would work.

.....

.....

..... [2]

*For
Examiner's
Use*

Please turn over for Question 5.

- 5 You are going to draw labelled diagrams to show the arrangement of apparatus in the following experiments.

*For
Examiner's
Use*

Large diagrams should be drawn carefully and labelled clearly.

- (a) A student separates insoluble copper oxide from a mixture of copper oxide with water.

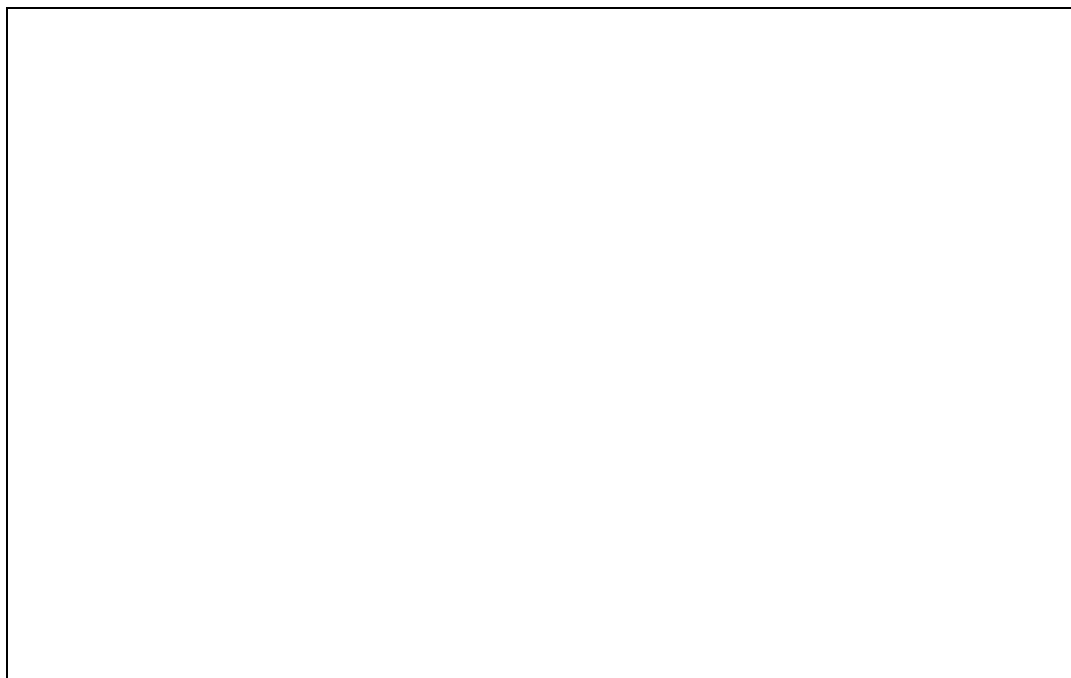

[2]

- (b) A student separates the colours in the ink from a felt-tip (marker) pen.

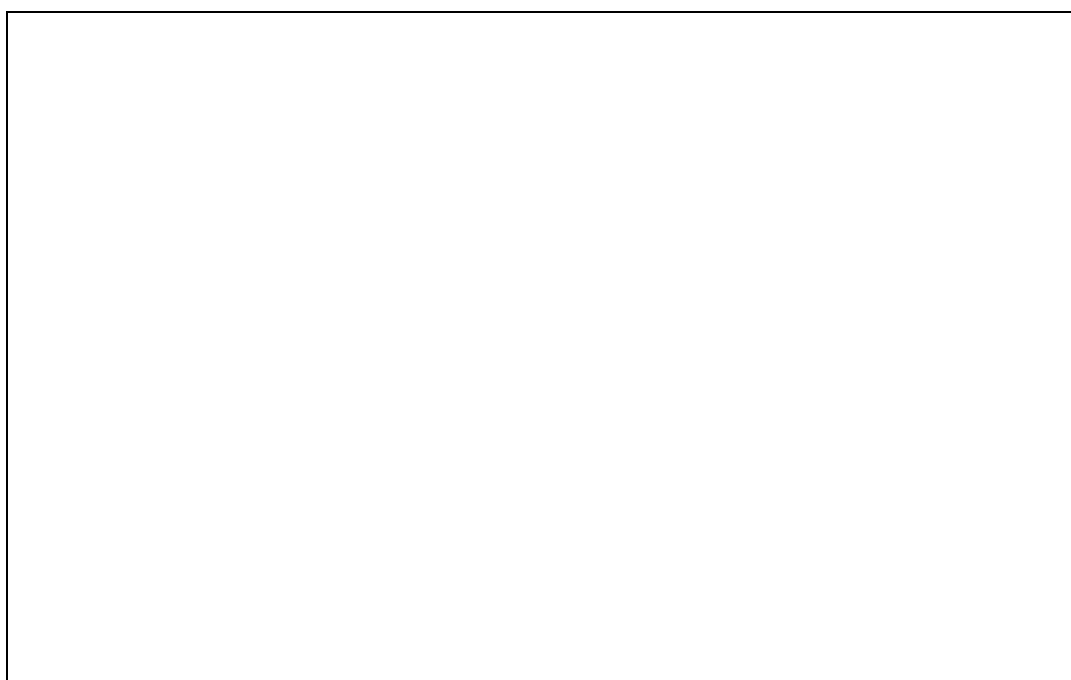

[2]

(c) A student measures the volume of ammonia gas evolved when a mixture of two solids are gently warmed.

*For
Examiner's
Use*

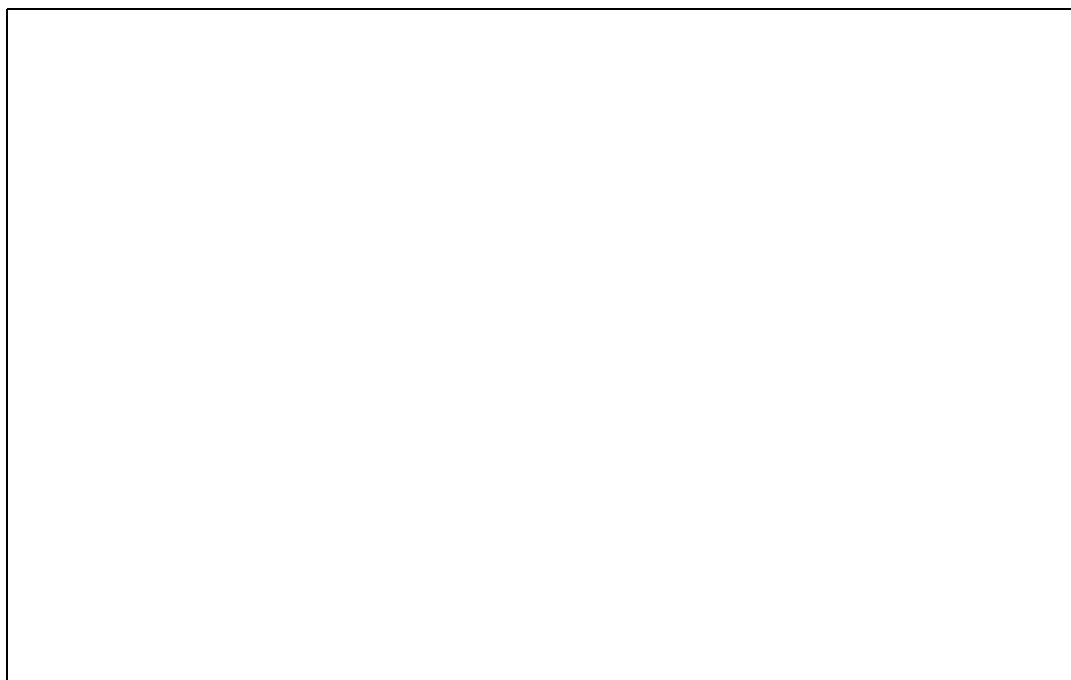

[2]

(d) A student separates pure water from a salt solution.

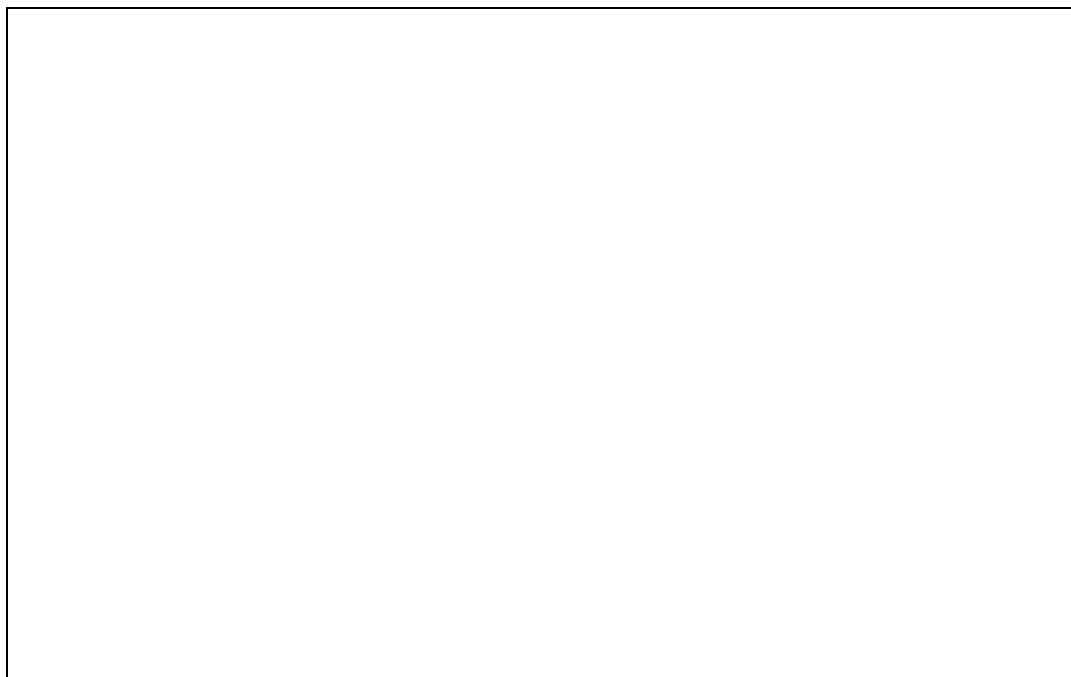

[2]

(e) Describe in detail how you would separate a mixture of two liquids with different boiling points.

.....

.....

.....

[2]

- 6 (a) A student is finding the value of an unknown mass, M , of a fixed load by balancing it against a range of known masses on a metre rule.

For
Examiner's
Use

The apparatus is set up as shown in Fig 6.1.

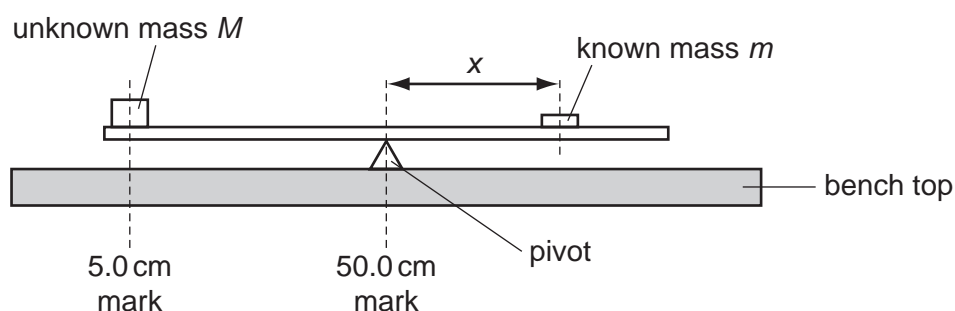

Fig. 6.1

The unknown load of mass M , is fixed at the 5.0 cm position. The student places a 60 g mass, m , on the ruler. He adjusts the position of mass m , until the ruler is balanced. He records the distance, x cm, from the 50.0 cm balance point in Table 6.1.

Table 6.1

mass m/g	distance x/cm	$\frac{1}{x}$
60	37.4	
70	31.9	
80		
90		
100	22.7	

- (i) Use Fig 6.2 to find the distance, x , for masses equal to 80 g and 90 g and complete column 2 of Table 6.1. Measure to the centre of the mass. [2]

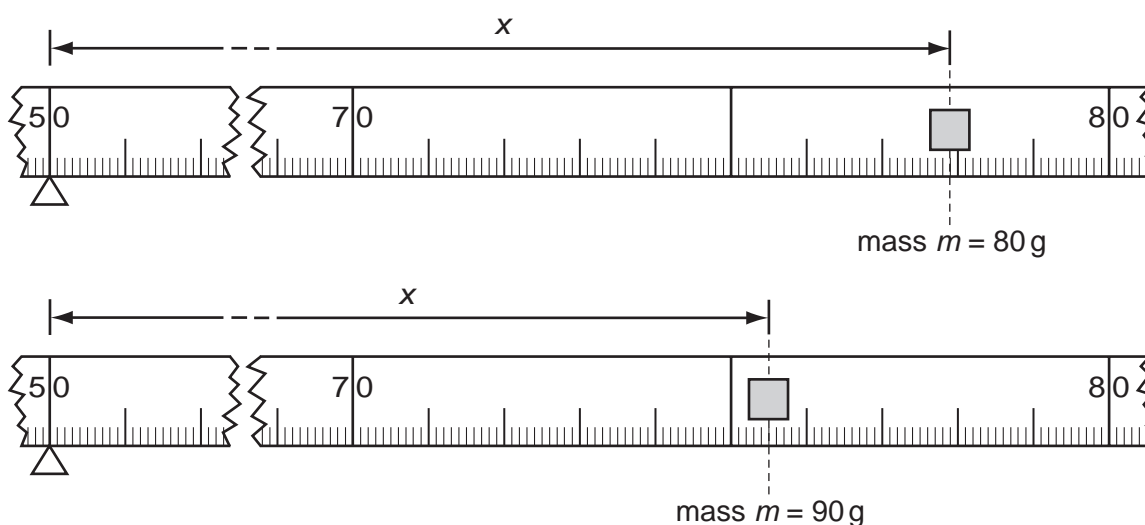
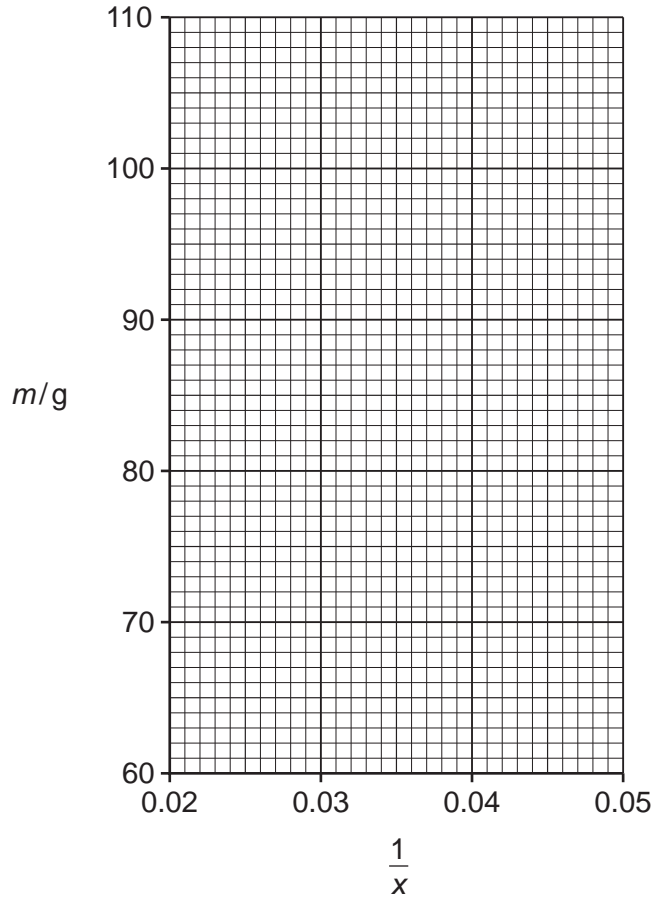

Fig. 6.2

(ii) Calculate $\frac{1}{x}$ for each value of x and record your answers to 3 decimal places in Table 6.1. [2]

(b) (i) On the grid provided, plot a graph of mass, m , (vertical axis) against $\frac{1}{x}$. Draw the best straight line.



[2]

(ii) Calculate the gradient of the line. Show clearly, on the graph, how you did this.

gradient of the line [2]

(c) Calculate the value of the unknown load of mass M , using the equation

$$M = \frac{\text{gradient}}{45}$$

$M = \dots\dots\dots$ g [1]

(d) This method of finding unknown masses is unsuitable for very small or very large masses.

Suggest a reason for either of these.

..... [1]

*For
Examiner's
Use*