

Core 1

(a) Fig. 1 shows three types of water tap (faucet).

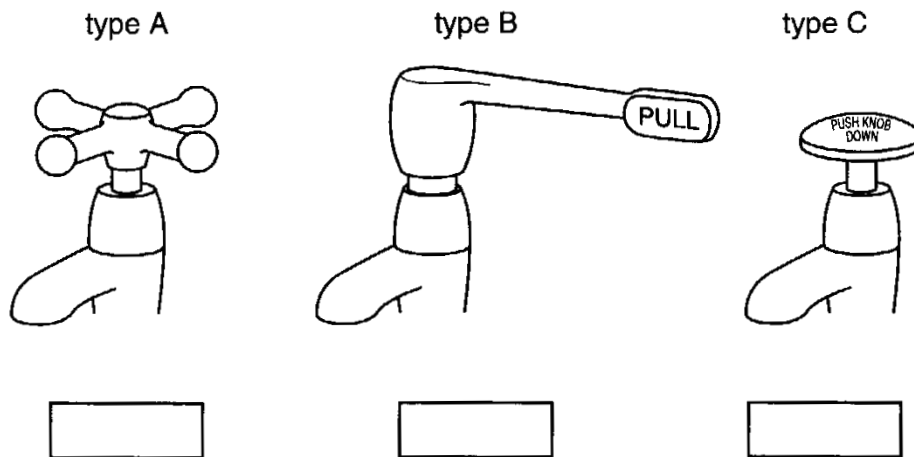

Fig. 1

In the box underneath each tap, write YES if a person would need to cause a moment on the handle in order to make the water flow, or NO if the person would not need to cause a moment. [3]

(b) A old person has taps of type A in the kitchen. The person has difficulty operating the tap. What could be done to make it easier to operate the tap?

.....[1]

Core 2

The hammers A and B shown in Fig. 2 consist of steel hammer-heads of different weights fitted to identical wooden handles.

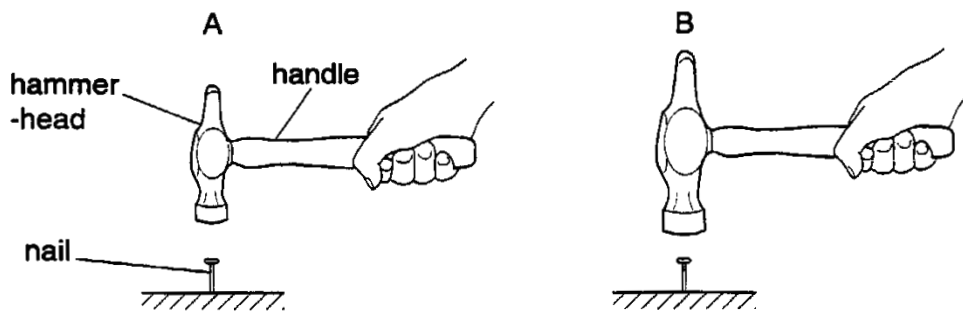

Fig. 2

- (a) (i) Which hammer-head causes the greater moment about the end of the handle when the hammer is held horizontally, as shown in Fig. 2 ?

ANSWER: hammer

- (ii) Explain your answer.

.....
[3]

- (b) (i) Which hammer-head requires the greater work to lift it a distance of 30 cm from the position shown?

ANSWER: hammer

- (ii) Explain your answer.

.....
[3]

- (c) If you wanted to estimate the power developed when lifting hammer A through 30 cm, what two other quantities would you need to measure?

1.
2.[2]

- (d) One of the hammers hits the nail and comes to rest without bouncing.

- (i) What form of energy did the hammer lose when it came into contact with the nail?

.....

- (ii) State two forms of energy into which this "lost" energy is changed.

1.
2.[3]

Core 3

- (a) Heavy furniture sometimes marks the floor on which it stands. Four tables of the same weight each have four legs. Fig. 3 shows part of a leg from each table.

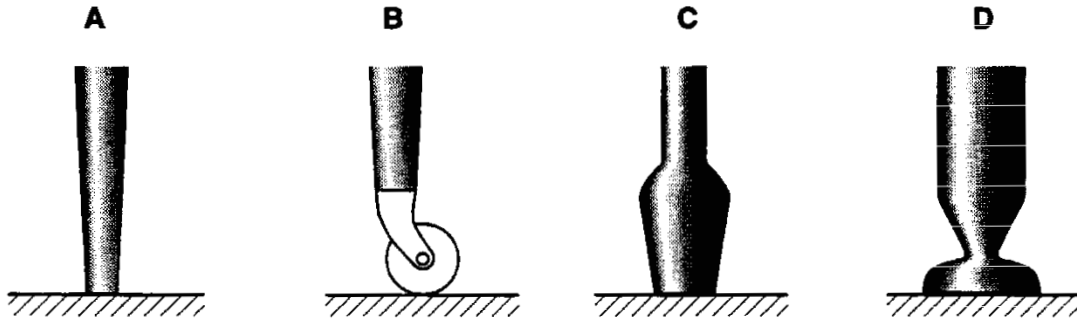

Fig. 3

- (i) Which leg is least likely to mark the floor underneath it?
- (ii) Explain your answer.

.....

.....[3]

Core 3

(b) A hot flat metal sheet is placed on a horizontal surface.

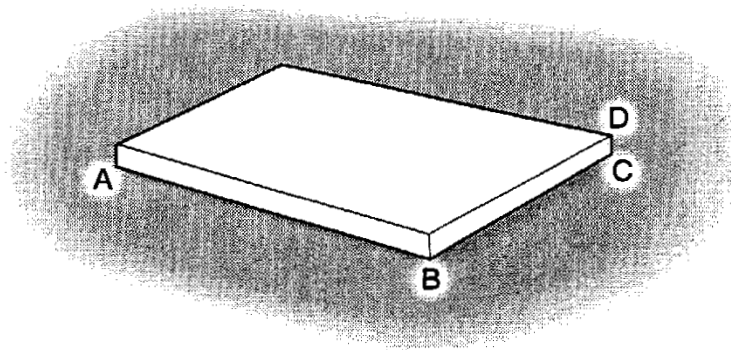

Fig. 4

As the hot metal sheet cools, what happens to the quantities in the list below?
Tick **one** answer for each.

	increases	decreases	stays the same
length AB			
width BC			
thickness CD			
area touching the horizontal surface			
mass of sheet			
weight of sheet			
density of metal			
pressure on horizontal surface			

[6]

Alternative to Practical 1

The lever balance shown in Fig. 5 was constructed from a straw AB fitted with a pointer at one end and a piece of card. The balance was supported on a pivot and the straw set horizontal by adjusting the position of a small counterweight. The height of the pointer was measured by using a metre rule placed beside the apparatus.

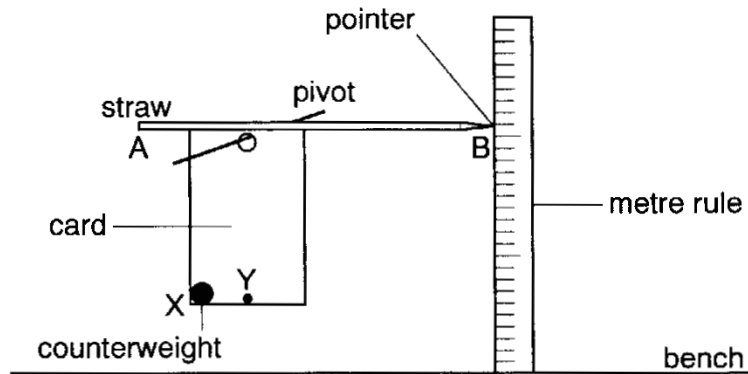

Fig. 5

- (a) Describe how you would check that the metre rule was perpendicular to the bench. You may draw on Fig. 5 .

.....
.....
..... [1]

- (b) When the counterweight was placed at the corner X of the card, the straw was found to be horizontal. In the space below, draw a sketch of the straw to represent its position when the counterweight was attached at the point labelled Y, not X.

[2]

Alternative to Practical 1

(c) With the straw horizontal, as shown in Fig. 5, a small paper clip was attached to the end A of the straw. The balance came to rest as shown in Fig. 6. Write down the reading shown for the height of the pointer B.

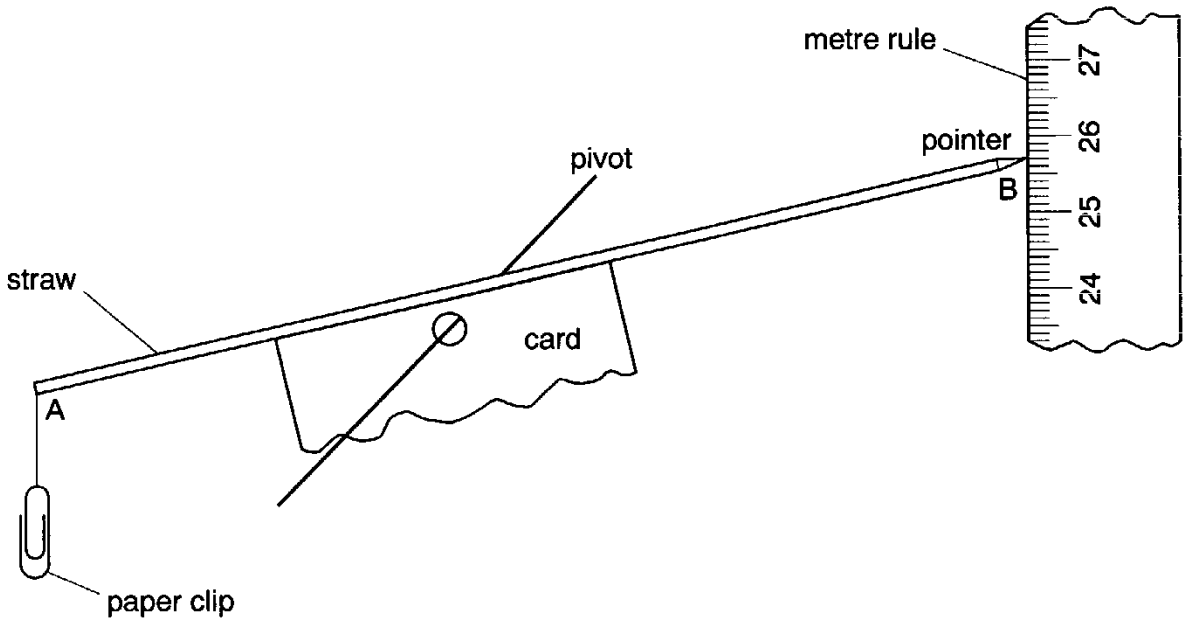

Fig. 6

pointer reading = [1]

(d) In one experiment, additional clips were attached to the end of the straw. The clips were added one at a time. After each clip had been added, the height h of the pointer was determined. Draw up a table in which you could record the values of h together with the corresponding total number of clips used. Your table should be suitable for use in your laboratory book.

Alternative to Practical 1

- (e) The distance d moved by the pointer, for each number n of paper clips hung from the balance, was calculated from the values of h . The graph of Fig. 7 represents the results of one experiment.

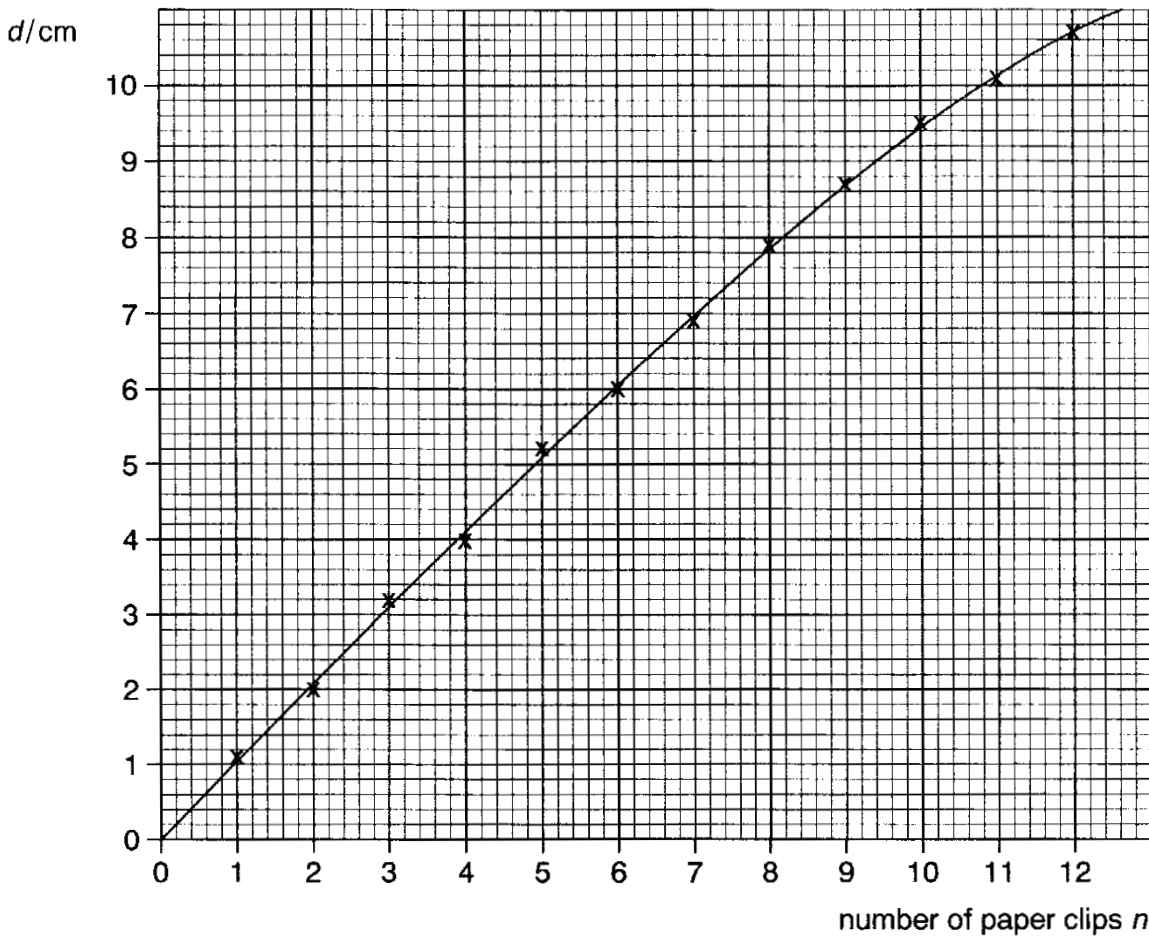

Fig. 7

The paper clips were removed from the straw and a small mass of plasticine was hung on the end A of the straw. The following information was obtained when this small mass of plasticine was in air and when it was totally submerged in water.

with the plasticine in air, the distance moved by the pointer $d_a = 9.1$ cm
 with the plasticine in water, the distance moved by the pointer $d_w = 4.6$ cm

- (i) From Fig. 7 determine the corresponding value for the number n of clips in use.

for $d_a = 9.1$ cm, $n_a = \dots\dots\dots$

for $d_w = 4.6$ cm, $n_w = \dots\dots\dots$

- (ii) The values for n_a and n_w are not the same. As well as its weight, another force F is acting on the plasticine when it is submerged in water.

1. In which direction does F act?

2. Using the information you gave in (i) what can you say about the magnitude of F ?

.....

[2]

Extension 1

Fig. 8 shows a person raising a concrete block from a river bed by using two pulleys.

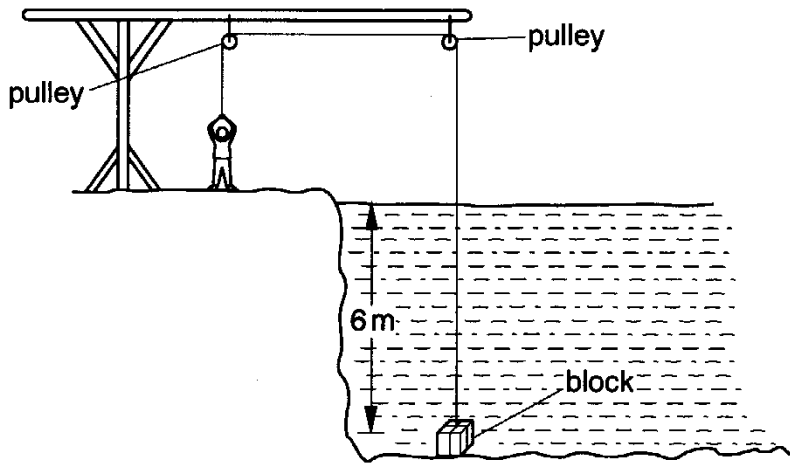

Fig. 8

- (a)** As shown in Fig. 8, the top of the block is 6.0 m below the water surface. The density of water is 1000 kg/m^3 and the acceleration of free fall is 10 m/s^2 .

Calculate the water pressure acting on the top of the block.

pressure = [3]

- (b)** The block is raised through the water. At one point, the water pressure acting on the top of the block is $4.5 \times 10^4 \text{ Pa}$. The area of the top of the block is 0.015 m^2 . Calculate the downward force exerted by the water on the top of the block.

force = [2]

- (c)** When the block is clear of the water, it is raised a further 4.0 m. The weight of the block is 550 N. Calculate the work done on the block as it is raised the 4.0 m through the air.

work = [2]

- (d)** Some of the energy the person uses to raise the block is converted into heat energy. Indicate on the Fig. 8, using an arrow and the letter H, two places where heat is released. For each place, explain why heat is released there.

.....

 [4]

Extension 2

Fig. 9 shows a 0.5 kg mass hanging freely on a length of steel wire.

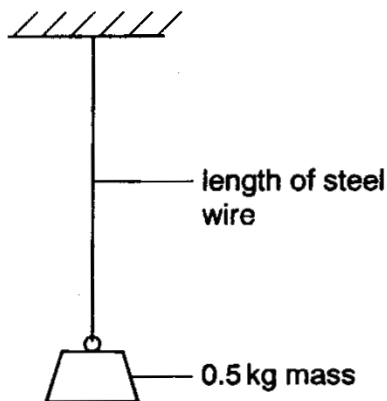

Fig. 9

- (a) On Fig. 9 use labelled arrows to indicate the direction and line of action of each of the two forces acting on the 0.5 kg mass.

The acceleration of free fall is 10 m/s^2 . Calculate the values of the two forces which you have indicated.

first force = second force = [4]

- (b) Suggest what causes the two forces to act on the mass.

.....
.....
.....[2]

Extension 2

(c) The 0.5 kg mass is increased by steps of 0.5 kg up to 10 kg. The corresponding extensions of the steel wire are measured. When the mass on the wire is 10 kg, the wire snaps. Fig. 10 shows part of the graph of extension against load for the wire.

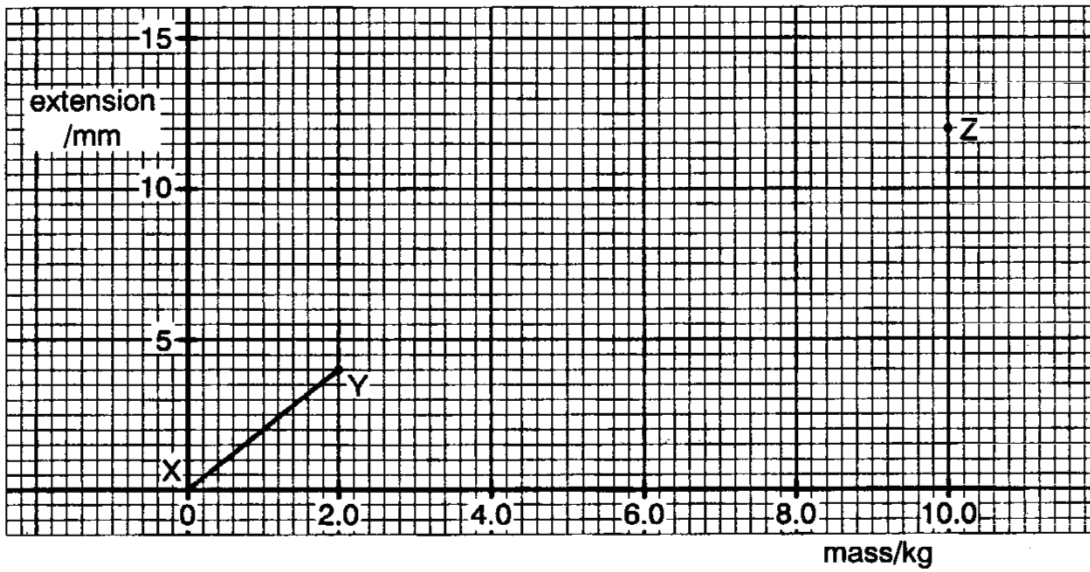

Fig. 10

(i) On Fig. 10, sketch a possible graph line between Y and Z.

(ii) Determine the mass needed to produce an extension of 3 mm.

mass =

(iii) Determine the extension of the wire just before it snaps.

extension =

[4]

Core 1

- a Yes Yes No
- b increase the diameter of the handle
change it to B / C

Core 2

- a(i) B
- (ii) greater weight or force or heavier hammer head
- b(i) B
- (ii) as (ii) above
- c weight of hammer
time to lift
- d(i) kinetic energy or energy of motion
- (ii) heat
sound

Core 3

a(i) D

(ii) largest area creates least pressure

b

	increases	decreases	stays the same
length AB		✓	
width BC		✓	
thickness CD		✓	
area touching the horizontal surface		✓	
mass of sheet			✓
weight of sheet			✓
density of metal	✓		
pressure on horizontal surface	✓		

Alternative to Practical 1

- a any suitable vertical such as set-square or plumb-line
- b the straw is no longer horizontal
B moves downwards
- c 25.7 cm
- d a table with two columns identified and with units
- e(i) $n_a = 9.44$ or 9.5
 $n_w = 4.4$ or 4.5
- (ii) upwards
smaller than the weight

Extension 1

a pressure = height x density x g

$$= 6 \times 1000 \times 10$$

$$= 60\,000 \text{ Pa}$$

b force = pressure x area

$$= 45\,000 \times 0.015$$

$$= 680 \text{ N}$$

c work done = force x distance

$$= 550 \times 4$$

$$= 2200 \text{ J}$$

d places at the pulley axles
 in the persons body
 at the block

energy is transferred against friction
and in moving parts of the body

Extension 2

a downward force through the centre of the mass and upward force along the wire

downward force = 5 N upward force or tension = 5 N

b downward weight or gravity or pull of the earth

upward tension or pull of wire

c(i) initially a straight line then a curve of decreasing gradient to Z

(ii) 1.5 kg

(iii) 12 mm