



UNIVERSITY OF CAMBRIDGE INTERNATIONAL EXAMINATIONS
International General Certificate of Secondary Education

CANDIDATE
NAME

CENTRE
NUMBER

--	--	--	--	--

CANDIDATE
NUMBER

--	--	--	--



PHYSICS

0625/63

Paper 6 Alternative to Practical

October/November 2010

1 hour

Candidates answer on the Question Paper.
No Additional Materials are required.

READ THESE INSTRUCTIONS FIRST

Write your Centre number, candidate number and name on all the work you hand in.
Write in dark blue or black pen.
You may use a pencil for any diagrams, graphs or rough working.
Do not use staples, paper clips, highlighters, glue or correction fluid.
DO NOT WRITE IN ANY BARCODES.

Answer **all** questions.

At the end of the examination, fasten all your work securely together.
The number of marks is given in brackets [] at the end of each question or part question.

For Examiner's Use	
1	
2	
3	
4	
5	
Total	

This document consists of **11** printed pages and **1** blank page.



- 1 The IGCSE class is studying the acceleration of a toy car that is pulled along a track by a force F .

The arrangement is shown in Fig. 1.1.

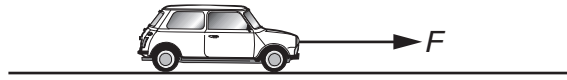

Fig. 1.1

A student uses a force F of 0.5 N to pull a toy car along a track and electronically measures the acceleration a . He records the results in a table. He repeats the procedure using a range of different forces up to 2.5 N. The readings are shown in Table 1.1.

Table 1.1

$\frac{F}{\text{N}}$	$\frac{a}{\text{m/s}^2}$
0.5	0.35
1.0	0.72
1.5	1.02
2.0	1.44
2.5	1.74

- (a) Plot a graph of $\frac{F}{\text{N}}$ (y-axis) against $\frac{a}{\text{m/s}^2}$ (x-axis).

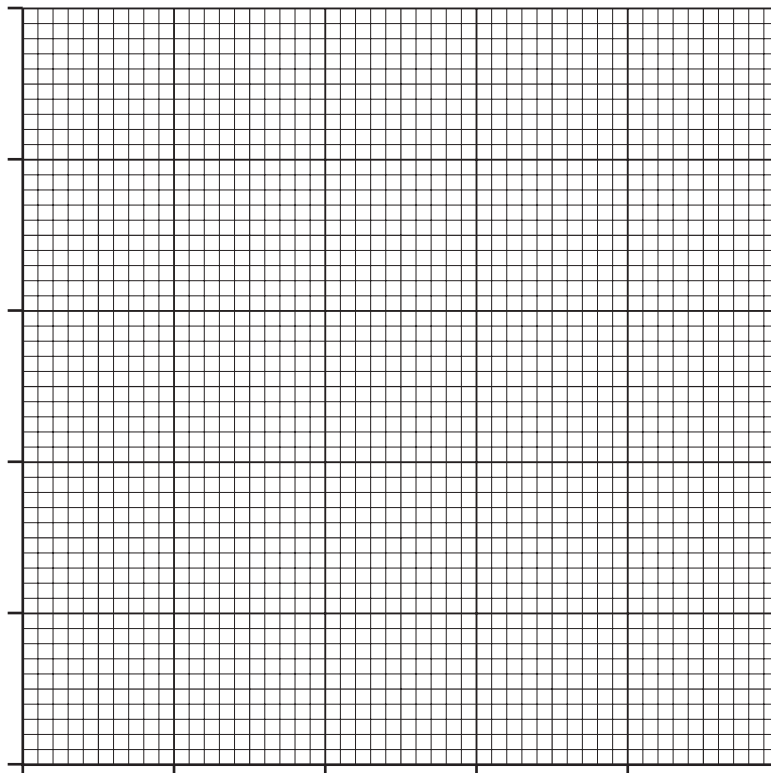

[5]

- (b) Theory suggests that the acceleration is directly proportional to the force applied to the toy car. State whether the results support this suggestion and justify your statement by reference to the graph.

statement

justification

..... [2]

- (c) The gradient of the graph is equal to the mass of the toy car. From the graph, determine the mass m of the toy car. Show clearly how you obtained the necessary information.

$m =$ [3]

[Total: 10]

- 2 The IGCSE class is investigating the rate of cooling of water under different conditions.

Fig. 2.1 shows the apparatus.

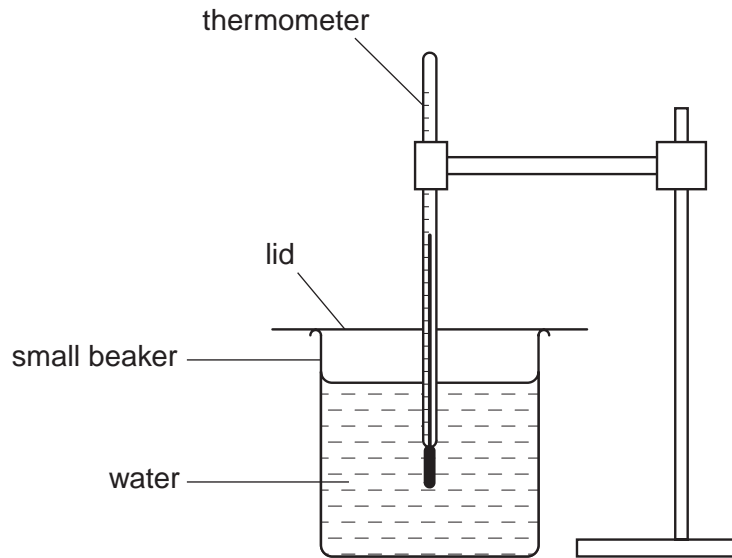

Fig. 2.1

- (a) Fig. 2.2 shows a thermometer at room temperature θ_r . Record room temperature θ_r .

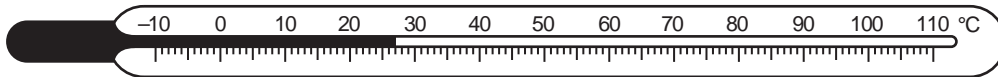

Fig. 2.2

$\theta_r = \dots\dots\dots$ [1]

(b) A student pours approximately 75cm^3 of hot water into the small beaker. When the temperature shown on the thermometer stops rising, he records the temperature θ in Table 2.1 at time $t = 0\text{s}$ and immediately starts a stopclock. He records the temperature of the water at 30 s intervals. He then proceeds as follows:

- he empties the water from the beaker;
- he places the empty beaker into a larger beaker;
- he pours fresh hot water into the small beaker;
- he takes a new set of readings, recording them in Table 2.2.

Table 2.1

$t/$	$\theta/$
0	79
30	79
60	79
90	78
120	77
150	75
180	75

Table 2.2

$t/$	$\theta/$
0	80
30	80
60	79
90	78
120	77
150	75
180	74

- (i) Complete the column headings in both tables.
- (ii) State whether the rate of cooling of the water is significantly faster or slower or about the same under the conditions used in Table 2.1 compared with the conditions in Table 2.2. Justify your answer by reference to the readings.

statement

justification

..... [3]

(c) In order to make this experiment a fair test it is important to control the conditions. Suggest two such conditions that should be controlled.

1.

2. [2]

[Total: 6]

3 The IGCSE class is investigating resistance in an electrical circuit.

Part of the circuit is shown in Fig. 3.1.

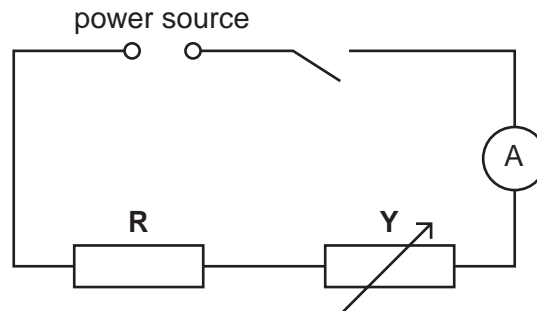

Fig. 3.1

(a) (i) Complete the circuit diagram by drawing in the symbol for a voltmeter connected across the resistor **R**. [2]

(ii) Name the component labelled **Y**.

..... [1]

(b) The first reading on the voltmeter is 2.2V. On the voltmeter face shown in Fig. 3.2, show the position of the pointer giving the reading 2.2V.

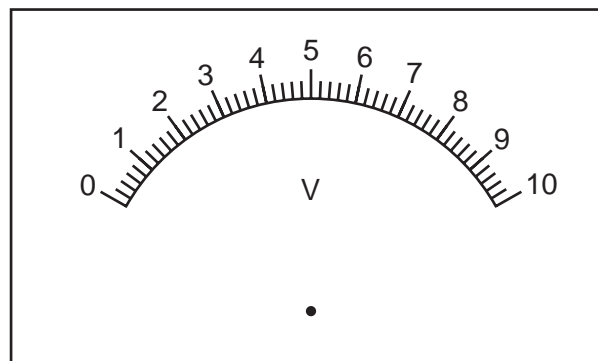

Fig. 3.2

[1]

- (c) A student takes readings of the potential difference V across the resistor R and the current I in it. The readings are shown in Table 3.1.

For
Examiner's
Use

Table 3.1

$V/$	$I/$	$R/$
2.2	0.36	
4.1	0.68	
6.0	0.98	
7.9	1.28	
9.8	1.61	

- (i) Calculate the resistance R of the resistor for each set of V and I readings and write the values in the table. Use the equation $R = \frac{V}{I}$. [2]

- (ii) Complete the column headings in the table. [1]

- (iii) A student suggests that the resistance R should be constant. State whether the results in the table support this suggestion and justify your answer by reference to the results.

statement

justification

.....

[2]

[Total: 9]

- 4 The IGCSE class is investigating shadows formed on a screen.

Fig. 4.1 shows the apparatus.

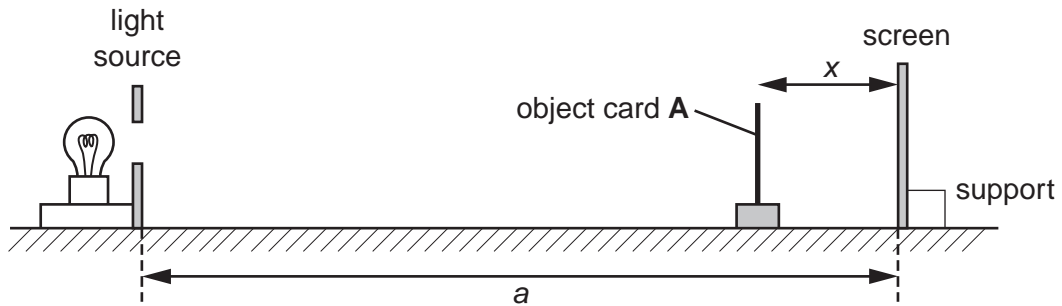

Fig. 4.1

The lamp is behind a piece of card. The card has a circular hole which, in this experiment, is referred to as the light source.

- (a) On Fig. 4.1, measure the distance a between the light source and the screen.

$a = \dots\dots\dots$ cm [1]

- (b) The diagram is drawn one third of actual size. Calculate the actual distance y between the light source and the screen.

$y = \dots\dots\dots$ cm [1]

- (c) A student places a circular object card **A** in a holder between the light source and the screen. Fig. 4.2 shows the card and holder.

For
Examiner's
Use

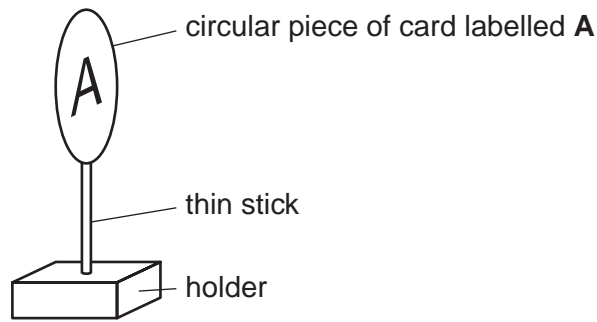

Fig. 4.2

Fig. 4.3 shows the object card drawn actual size.

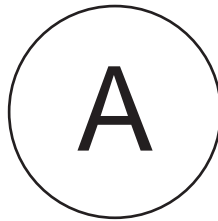

Fig. 4.3

Take and record measurements from Fig. 4.3 to determine the average diameter d of the object card.

$d = \dots\dots\dots$ cm [2]

- (d) The student places the object card at different distances x from the screen, as shown in Fig. 4.1. He switches on the light source and measures the diameter s of the shadow of the object card formed on the screen. The readings are shown in Table 4.1.

Table 4.1

x/cm	s/cm	s^2/cm^2
2.0	2.2	
4.0	2.4	
6.0	2.6	
8.0	2.8	
10.0	3.1	

- (i) Calculate the values of s^2 and enter them in the table. [2]
- (ii) A student suggests that the value of s^2 when $x = 10.0\text{cm}$ should be twice the value of s^2 when $x = 2.0\text{cm}$. State whether the experimental results support this suggestion and justify your statement by reference to the results.

statement

justification

.....

[2]

- (e) State two precautions you would take in order to obtain reliable measurements when carrying out this experiment.

1.

2. [2]

[Total: 10]

5 The IGCSE class is investigating the stretching of springs.

For
Examiner's
Use

Each student is able to use a selection of different springs, a set of slotted masses to hang on the end of a spring, a metre rule, and any other common laboratory apparatus that may be useful.

A student decides to investigate the effect of the type of metal from which the spring is made on the extension produced by loading the spring.

(a) Suggest three possible variables that should be kept constant in this investigation. (Do not include variables that are likely to have very little effect on the length of a spring in this context.)

1.
2.
3. [3]

(b) In the investigation, the original length l_0 of a spring is measured and then the new length l when a load is attached. Fig. 5.1 shows an unloaded spring and the same spring with a load attached. On Fig. 5.1, show clearly the original length l_0 and the new length l .

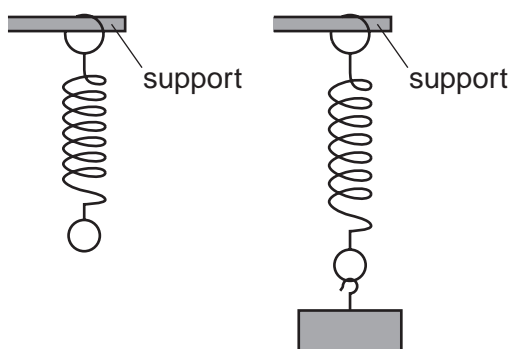

Fig. 5.1

[1]

(c) It is not possible to position a metre rule immediately next to the spring. Describe briefly how you would overcome this problem when measuring the length l . You may draw a diagram.

.....
 [1]

[Total: 5]

BLANK PAGE

Permission to reproduce items where third-party owned material protected by copyright is included has been sought and cleared where possible. Every reasonable effort has been made by the publisher (UCLES) to trace copyright holders, but if any items requiring clearance have unwittingly been included, the publisher will be pleased to make amends at the earliest possible opportunity.

University of Cambridge International Examinations is part of the Cambridge Assessment Group. Cambridge Assessment is the brand name of University of Cambridge Local Examinations Syndicate (UCLES), which is itself a department of the University of Cambridge.