

UNIVERSITY OF CAMBRIDGE INTERNATIONAL EXAMINATIONS
International General Certificate of Secondary Education

PHYSICS

0625/01

Paper 1 Multiple Choice

October/November 2004

45 minutes

Additional Materials: Multiple Choice Answer Sheet
Soft clean eraser
Soft pencil (type B or HB is recommended)

READ THESE INSTRUCTIONS FIRST

Write in soft pencil.

Do not use staples, paper clips, highlighters, glue or correction fluid.

Write your name, Centre number and candidate number on the Answer Sheet in the spaces provided unless this has been done for you.

There are **forty** questions on this paper. Answer **all** questions. For each question there are four possible answers **A, B, C, and D**.

Choose the **one** you consider correct and record your choice in **soft pencil** on the separate Answer Sheet.

Read the instructions on the Answer Sheet very carefully.

Each correct answer will score one mark. A mark will not be deducted for a wrong answer.

Any rough working should be done in this booklet.

This document consists of **14** printed pages and **2** blank pages.



1 A floor is covered with square tiles. The diagram shows a ruler on the tiles.

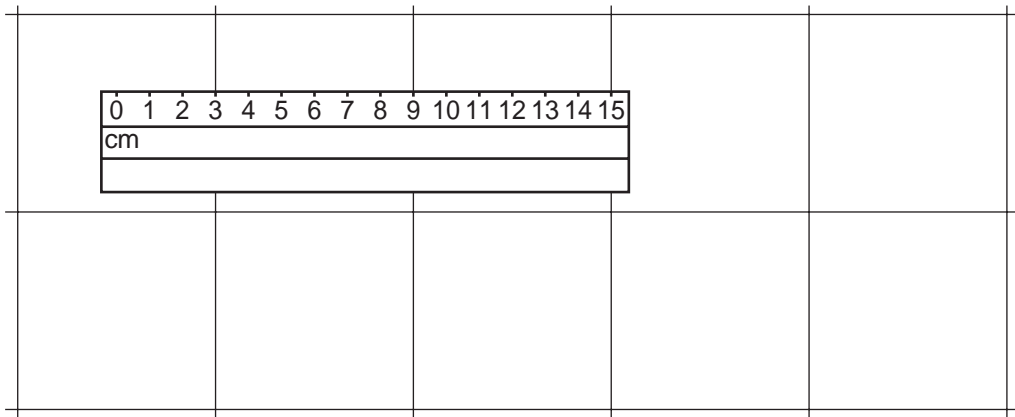

How long is one tile?

- A 3 cm B 6 cm C 9 cm D 12 cm

2 The diagrams show the times on a stopclock at the beginning and at the end of an experiment.

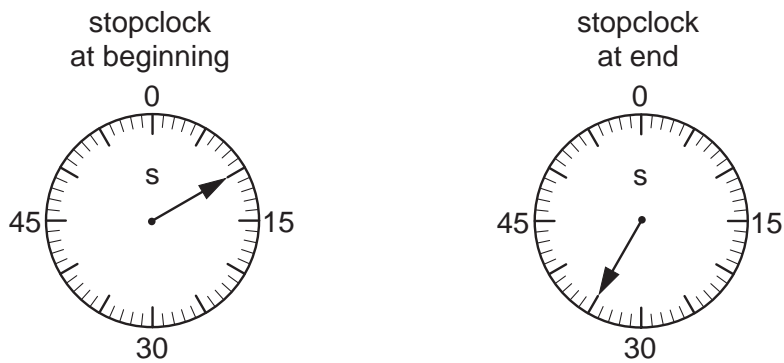

How long did the experiment take?

- A 10 s B 25 s C 35 s D 45 s

3 Which speed/time graph applies to an object at rest?

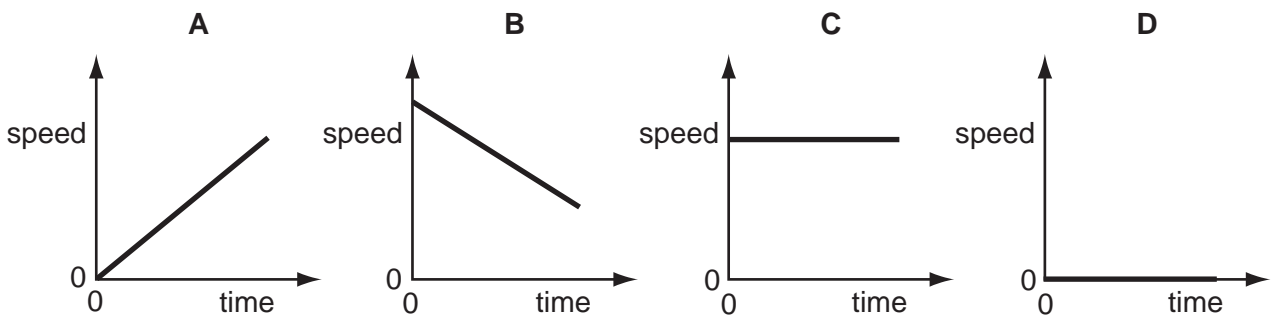

- 4 A racing car is fitted with an on-board computer. Every time the car passes the starting line, the computer records the distance travelled in the next 2 seconds.

Which set of data shows that the car is increasing in speed during the 2 seconds?

A

time / s	distance travelled / m
0	0
1	100
2	200

B

time / s	distance travelled / m
0	0
1	90
2	180

C

time / s	distance travelled / m
0	0
1	80
2	190

D

time / s	distance travelled / m
0	0
1	100
2	180

- 5 A spring is stretched by hanging a piece of metal from it.

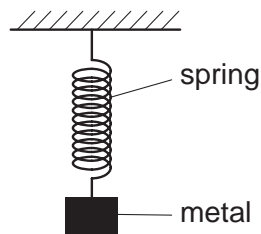

What is the name given to the force that stretches the spring?

- A friction
- B mass
- C pressure
- D weight

- 6 The diagram shows some liquid in a measuring cylinder. The mass of the liquid is 16g.

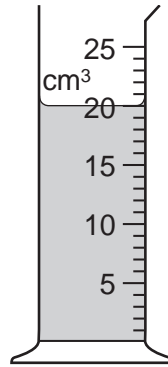

What is the density of the liquid?

- A 320g/cm³ B 36g/cm³ C 1.25g/cm³ D 0.8g/cm³
- 7 A student carries out an experiment to plot an extension / load graph for a spring. The diagrams show the apparatus at the start of the experiment and with a load added.

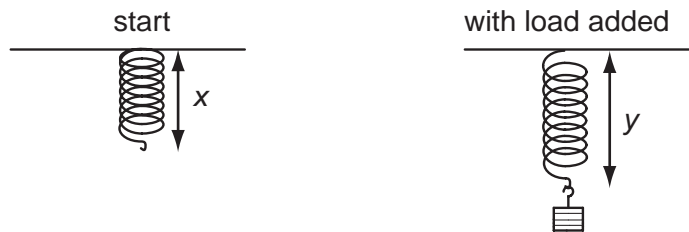

What is the extension caused by the load?

- A x B y C $y + x$ D $y - x$
- 8 Three horizontal forces act on a car that is moving along a straight, level road.

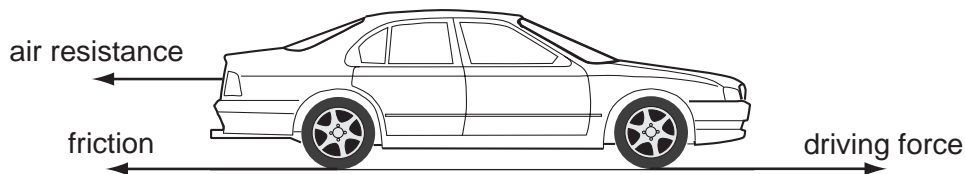

Which combination of forces would result in the car moving at constant speed?

	air resistance	friction	driving force
A	200 N	1000 N	800 N
B	800 N	1000 N	200 N
C	800 N	200 N	1000 N
D	1000 N	200 N	800 N

- 9 A child pushes a toy car along a level floor and then lets it go.

As the car slows down, what is the main energy change?

- A from chemical to heat
- B from chemical to kinetic
- C from kinetic to gravitational (potential)
- D from kinetic to heat

- 10 The diagram shows a cyclist riding along a hilly road.

At which position does the cyclist have the least gravitational (potential) energy?

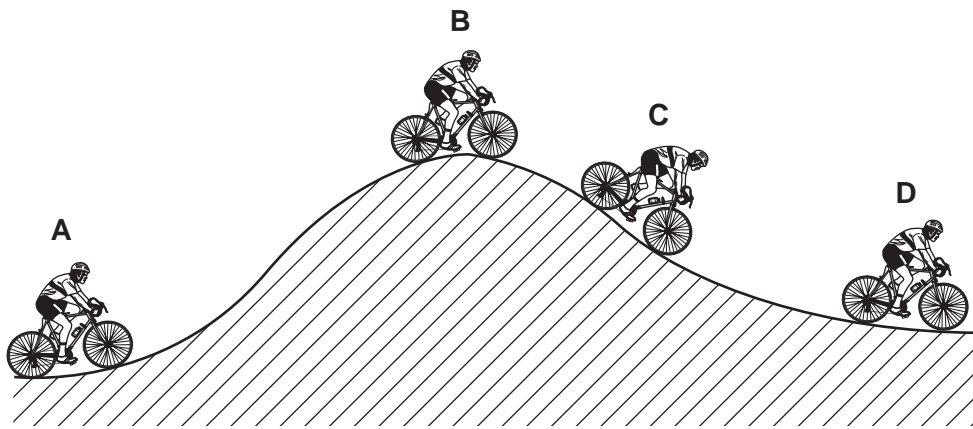

- 11 A pin is squeezed between finger and thumb.

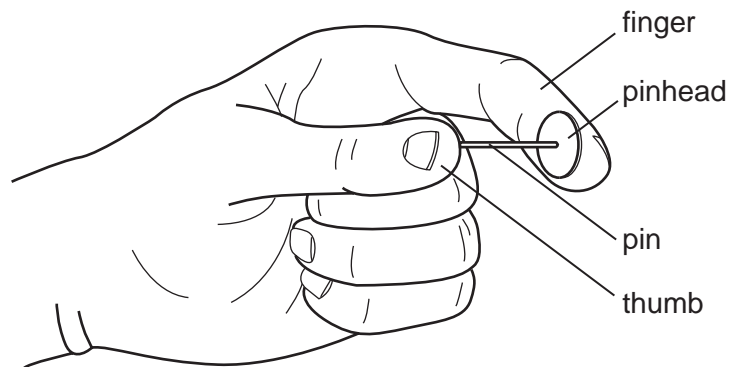

Which statement is correct?

- A The force of the pin is larger on the finger than on the thumb.
- B The force of the pin is larger on the thumb than on the finger.
- C The pressure of the pin is larger on the finger than on the thumb.
- D The pressure of the pin is larger on the thumb than on the finger.

- 12 Liquid X has a density of 1010 kg/m^3 . Liquid Y has a density of 950 kg/m^3 .

The liquids are poured into tubes as shown.

Which tube has the greatest pressure on its base?

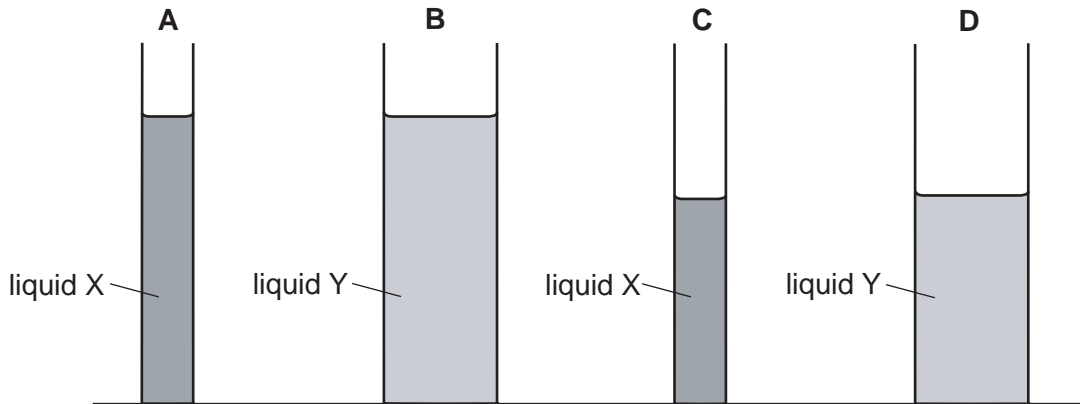

- 13 Some water molecules escape from the surface of a lake.

Which name is given to this process?

- A boiling
 - B convection
 - C evaporation
 - D radiation
- 14 The diagram represents gas molecules contained in a cylinder. The piston is moved slowly downwards and the temperature of the gas stays the same.

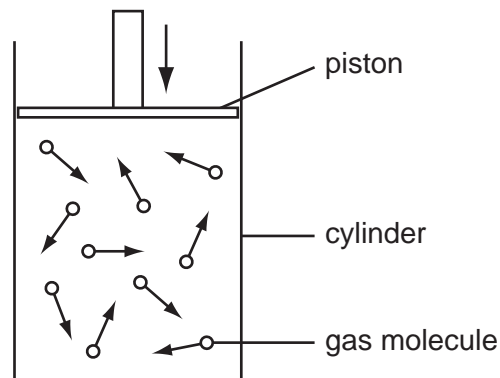

Why does the pressure of the gas increase?

- A The molecules collide harder with the walls.
- B The molecules collide more often with the walls.
- C The molecules move more quickly.
- D The number of molecules increases.

- 15 To mark the lower fixed point of a Celsius scale on a thermometer, the thermometer should be placed in
- A pure alcohol.
 - B pure distilled water.
 - C pure melting ice.
 - D pure mercury.
- 16 A glass flask full of cool water is placed in a container of hot water.

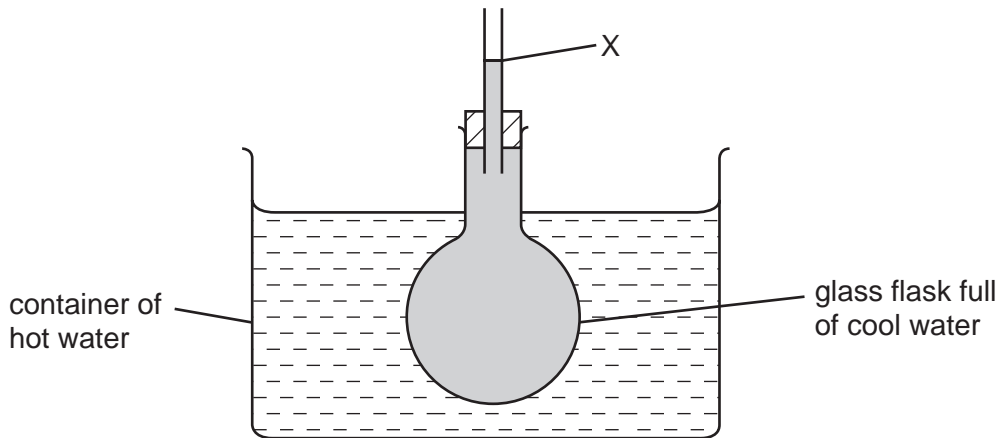

What will happen to the level of water at X as the cool water becomes warmer?

- A It will fall.
 - B It will rise.
 - C It will rise then fall.
 - D It will stay the same.
- 17 A beaker of water is heated at its base.
- Why does the water at the base rise?
- A It contracts and becomes less dense.
 - B It contracts and becomes more dense.
 - C It expands and becomes less dense.
 - D It expands and becomes more dense.

18 Which of these waves is longitudinal?

- A light waves
- B sound waves
- C water waves
- D X-ray waves

19 Waves move from deep water to shallow water where they are slower.

Which diagram shows what happens to the waves?

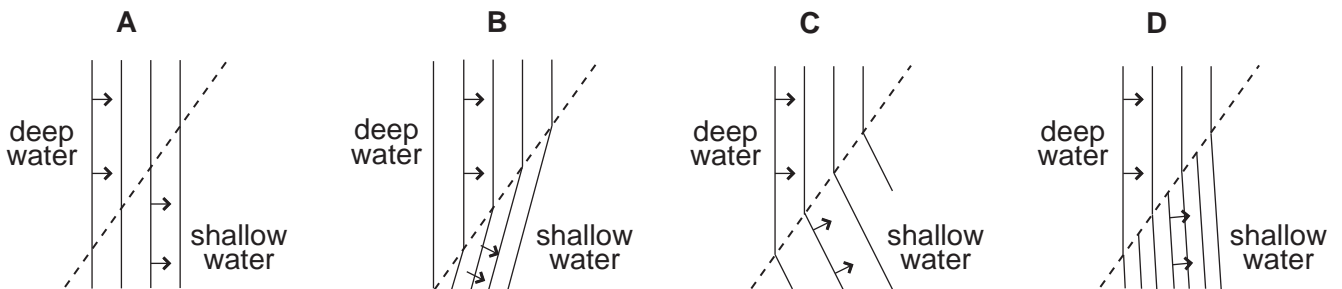

20 Which type of radiation lies between visible light and microwaves in the electromagnetic spectrum?

- A infra-red
- B radio waves
- C ultra-violet
- D X-rays

21 The critical angle for a glass/air boundary is C .

Which diagram shows the correct path of the light ray?

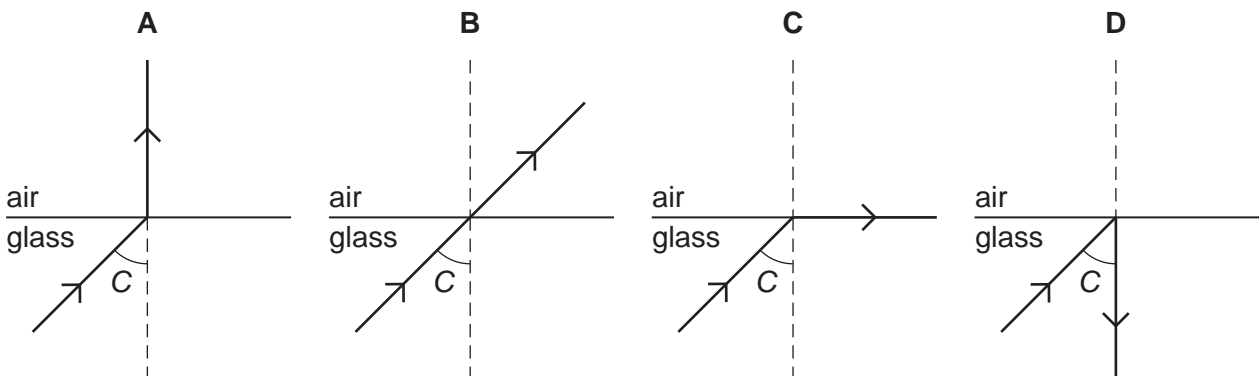

22 The diagram shows the image of a clockface in a plane mirror.

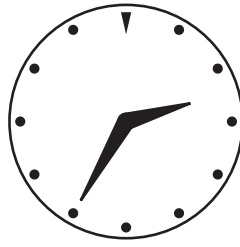

Which of these times is shown?

- A 02.25 B 02.35 C 09.25 D 09.35

23 What is the approximate range of audible frequencies for most humans?

- A 10 Hz to 10 000 Hz
 B 20 Hz to 20 000 Hz
 C 10 kHz to 10 000 kHz
 D 20 kHz to 20 000 kHz

24 A 100 metre race is started by firing a gun. The gun makes a bang and a puff of smoke comes out of the gun as shown.

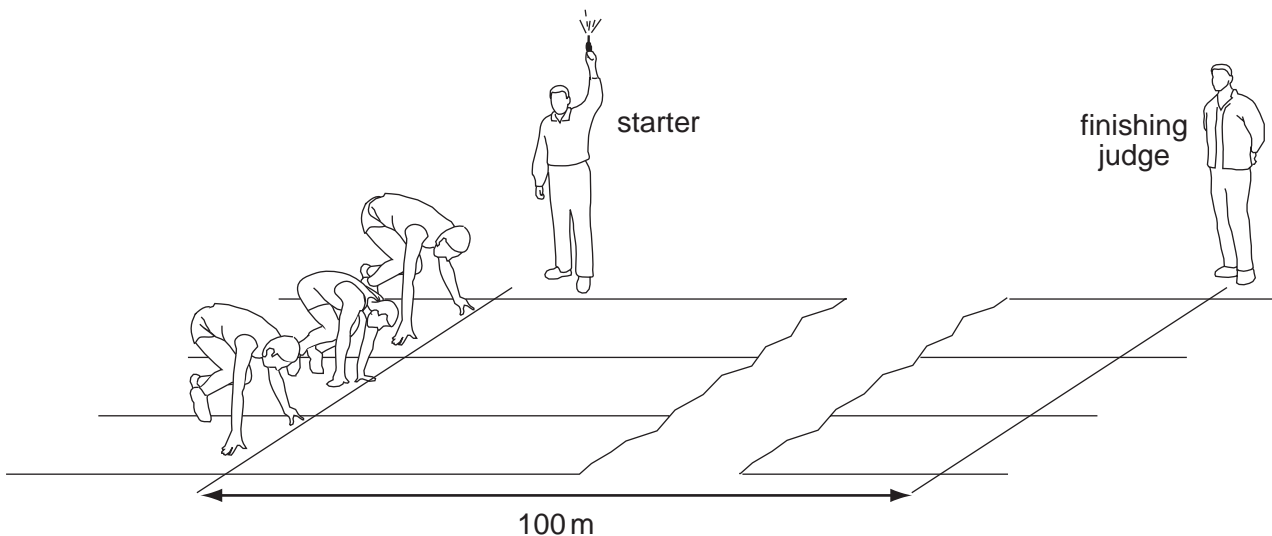

When does the finishing judge see the smoke and hear the bang?

	sees the smoke	hears the bang
A	immediately	immediately
B	immediately	after about 0.3 s
C	after about 0.3 s	immediately
D	after about 0.3 s	after about 0.3 s

25 Six small compasses are placed around a bar magnet.

Which diagram shows the directions in which the compass needles point?

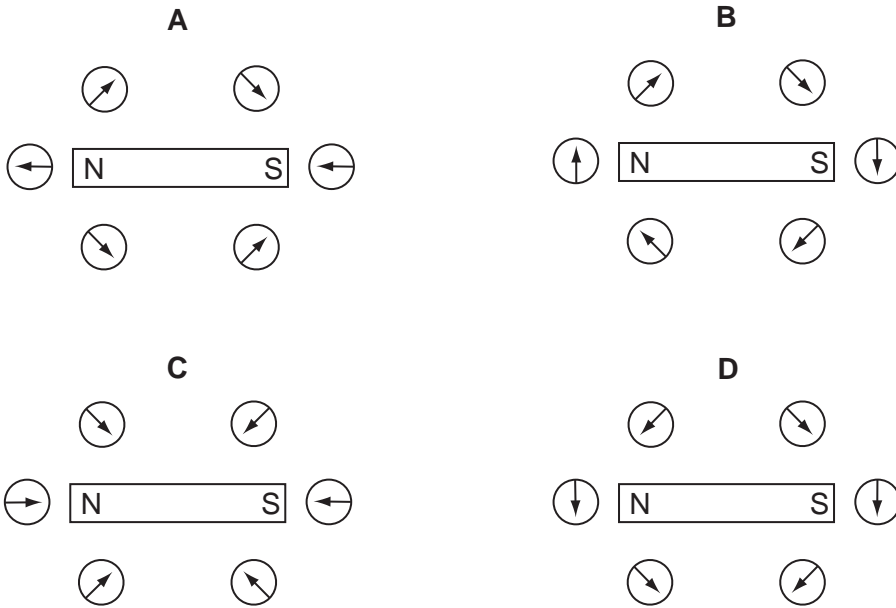

26 A student carries out four tests with a magnet.

Which result shown is **not** correct?

	arrangement	result
A	S magnet N iron bar	attracts
B	S magnet N S magnet N	attracts
C	N magnet S copper bar	no effect
D	N magnet S N magnet S	repels

27 A circuit is set up with a gap between two terminals X and Y. The four strips of material shown in the diagram are connected in turn across the gap.

Which strip completes the circuit so that the lamp lights?

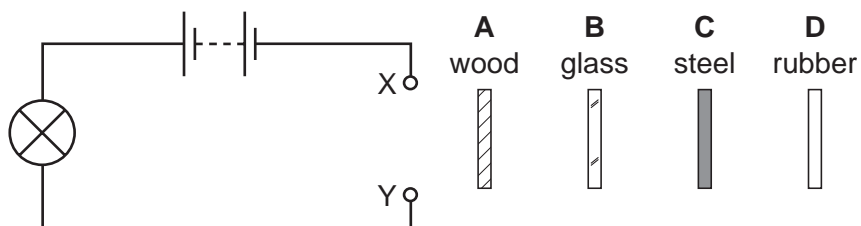

28 A pupil measures the potential difference across a device and the current in it.

Which calculation gives the resistance of the device?

- A current + potential difference
- B current \div potential difference
- C potential difference \div current
- D potential difference \times current

29 Which circuit could be used to find the resistance of resistor R?

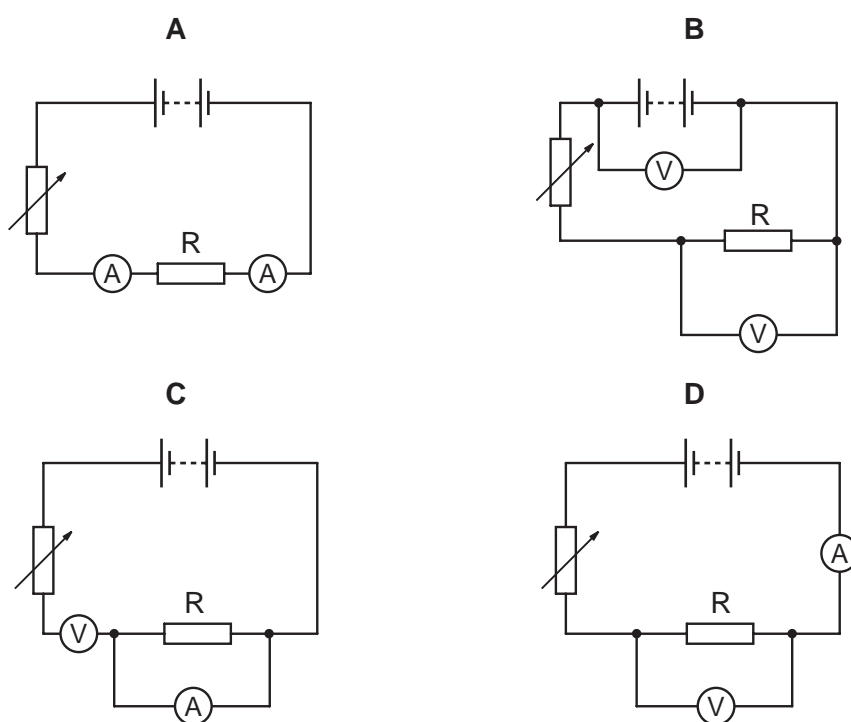

30 In the circuit shown, the reading on ammeter 1 is 2 A.

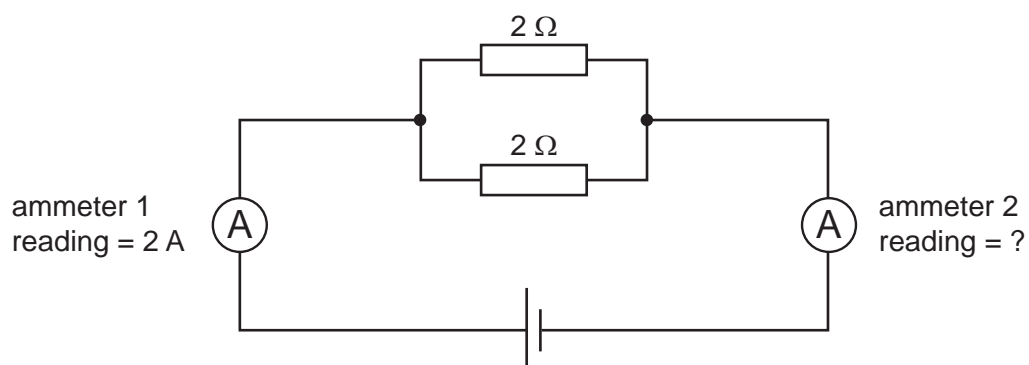

What is the reading on ammeter 2?

- A 0 A
- B 1 A
- C 2 A
- D 4 A

- 31 In which position in the circuit shown should a switch be placed so that both lamps can be switched on or off at the same time?

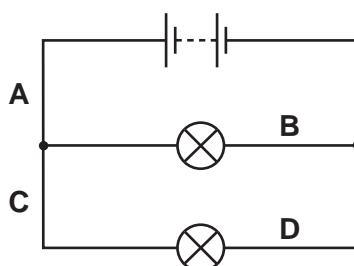

- 32 In the circuits shown, all the resistors are identical.

Which circuit has the **least** resistance?

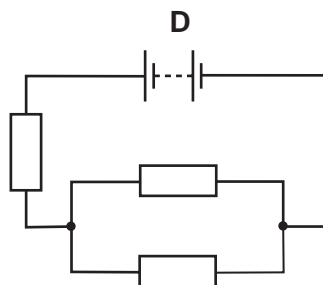
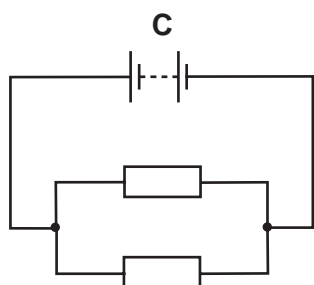
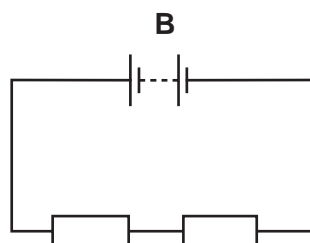
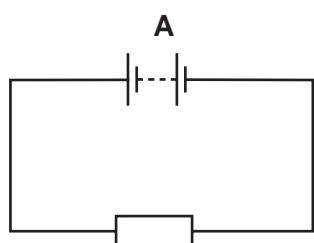

- 33 Why are electric circuits often fitted with fuses?

- A** Fuses break the circuit if the current is too high.
- B** Fuses only allow the current through in the correct direction.
- C** Fuses return any excess current to earth.
- D** Fuses use up any spare current.

- 34 A mains circuit can safely supply a current of 40 A.

A hair-drier takes 2 A. It is connected to the circuit by a lead which can carry up to 5 A.

Which of these fuses would be best to use in the plug fitted to the hair-drier lead?

- A** 1 A fuse
- B** 3 A fuse
- C** 10 A fuse
- D** 50 A fuse

35 The diagram represents a transformer.

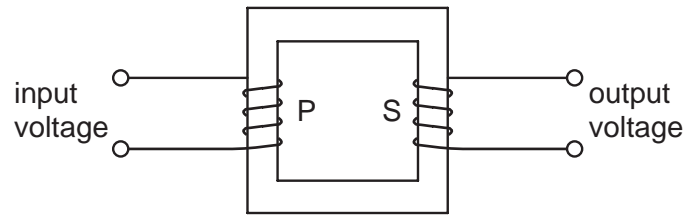

Which arrangement could be used to make the output voltage higher than the input voltage?

	number of turns on primary coil P	number of turns on secondary coil S	type of input
A	100	50	a.c.
B	100	50	d.c.
C	50	100	a.c.
D	50	100	d.c.

36 A student sets up the apparatus shown in order to make a relay.

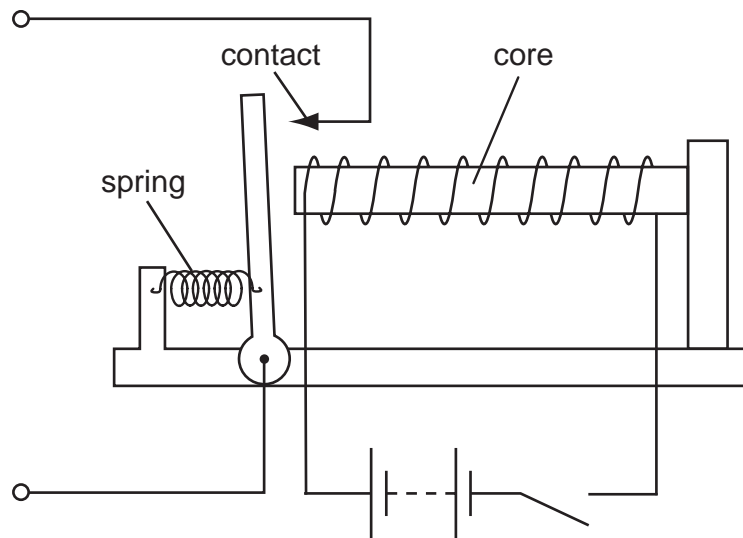

Which metal should be used to make the core?

- A** aluminium
- B** copper
- C** iron
- D** steel

37 Which particles are emitted during thermionic emission?

- A electrons
- B ions
- C neutrons
- D protons

38 The equation shows the decay of the nuclide X.

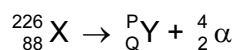

What are the values of P and Q?

	P	Q
A	230	90
B	230	86
C	222	90
D	222	86

39 During a fire in a laboratory storeroom, some radioactive material was spilled. A firefighter detected radiation through the lead-lined walls of the storeroom. The radiation was emitted by the radioactive material.

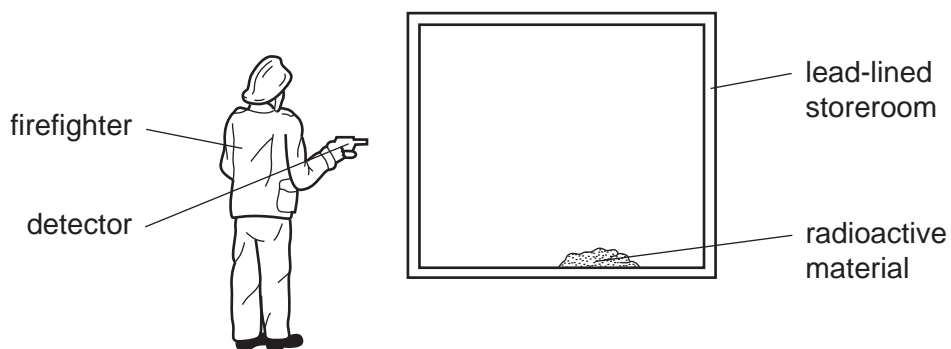

Which type of radiation was being detected?

- A α -particles
- B β -particles
- C γ -rays
- D X-rays

40 How many neutrons are in a nucleus of ${}_{6}^{14}\text{C}$?

- A 0
- B 6
- C 8
- D 14

Every reasonable effort has been made to trace all copyright holders where the publishers (i.e. UCLES) are aware that third-party material has been reproduced. The publishers would be pleased to hear from anyone whose rights they have unwittingly infringed.

University of Cambridge International Examinations is part of the University of Cambridge Local Examinations Syndicate (UCLES), which is itself a department of the University of Cambridge.