

UNIVERSITY OF CAMBRIDGE INTERNATIONAL EXAMINATIONS
International General Certificate of Secondary Education

PHYSICS

0625/05

Paper 5 Practical Test

May/June 2005

1 hour 15 minutes

Additional Materials: As specified in the Confidential Instructions

READ THESE INSTRUCTIONS FIRST

Follow the instructions on the front cover of the Answer Booklet.
Write your answers in the spaces provided in the Answer Booklet.

Answer **all** questions.

You are expected to record all your observations as soon as these observations are made.

An account of the method of carrying out the experiments is **not** required.

At the end of the examination, hand in only the Answer Booklet.

This document consists of **7** printed pages, **1** blank page and an inserted Answer Booklet.



- 1 In this experiment you are to investigate the change in temperature of hot water as cold water is added.

Record all your observations on pages 2 and 3 of your Answer Booklet.

Carry out the following instructions, referring to Fig. 1.1.

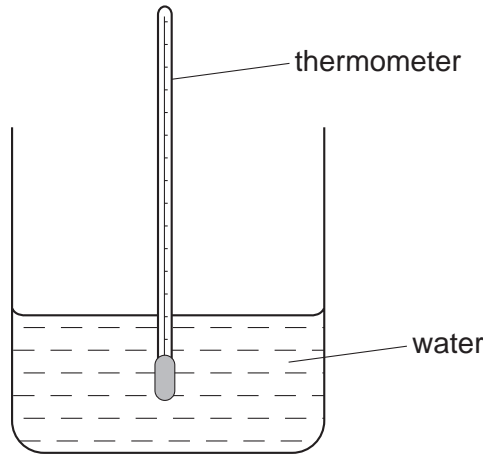

Fig. 1.1

- (a) You are provided with 100 cm^3 of hot water (labelled **A**) and a supply of cold water. The cold water is approximately at room temperature.
- (i) Measure and record the temperature of the cold water.
 - (ii) Measure and record in the first row of the table the temperature θ of the hot water.
 - (iii) Pour 20 cm^3 of the cold water into the measuring cylinder. Transfer this water to the beaker containing the hot water. Measure and record the temperature θ of the mixture of hot and cold water. Record the total volume V of cold water that you have added.
 - (iv) Repeat step (iii) four times until you have added a total of 100 cm^3 of cold water.
 - (v) Complete the column headings in the table.
 - (vi) Use the data in the table to plot a graph of θ (y -axis) against V (x -axis). Draw the best-fit curve.

(b) A student carrying out this experiment obtained the graph shown in Fig. 1.2.

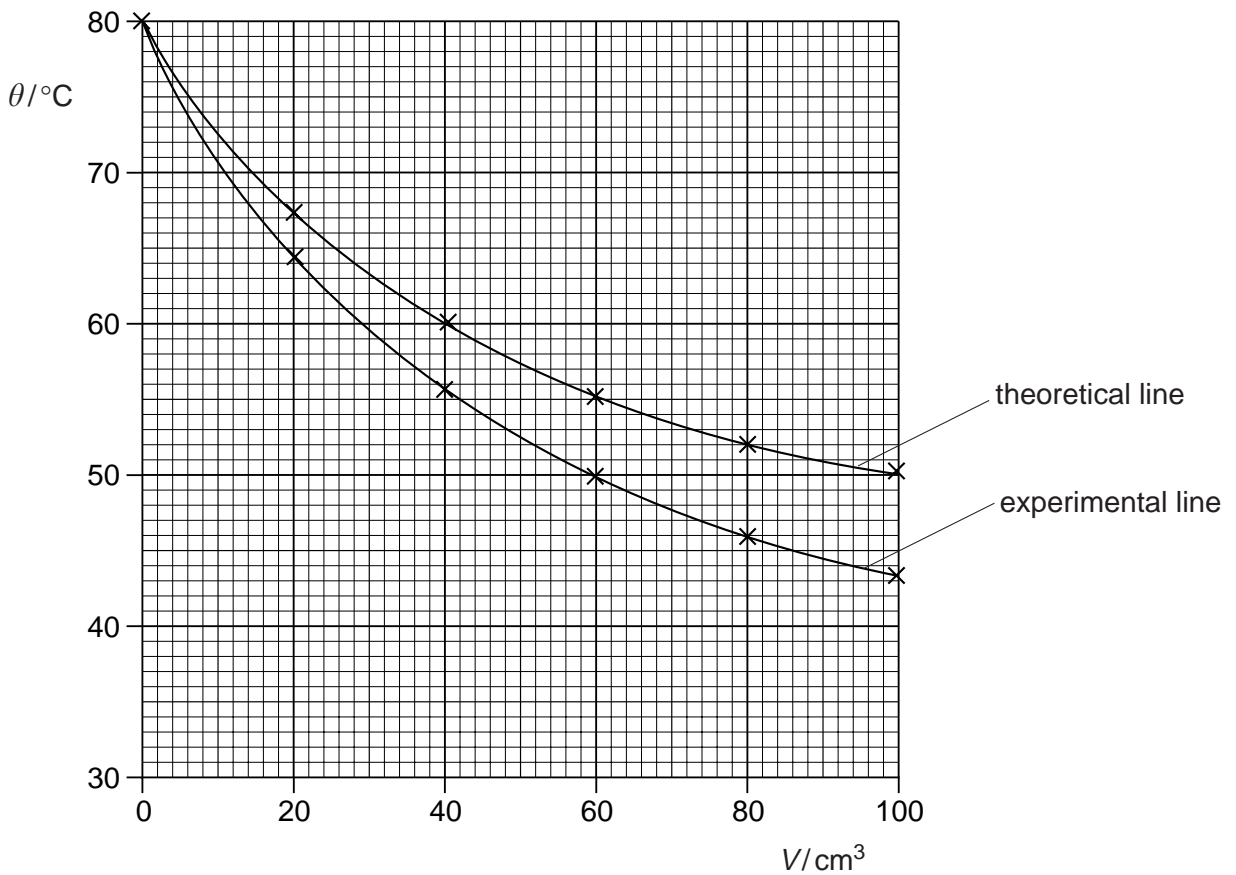

Fig. 1.2

The theoretical line shows the results expected by the student after calculating the values of θ . The student assumed that all the heat lost by the hot water was gained by the cold water when the cold water was poured into the beaker. The other line shows the student's experimental results.

The student had carried out the experiment with care. Suggest a practical reason why the experimental graph line differs from the theoretical line.

- 2 In this experiment you are to investigate the resistance of resistance wire in different circuit arrangements.

Record all your observations and readings on page 4 of your Answer Booklet.

The circuit shown in Fig. 2.1 has been set up for you.

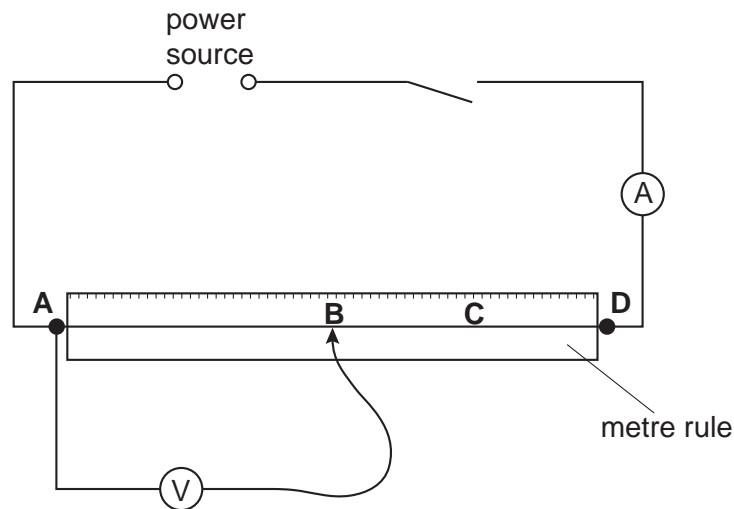

Fig. 2.1

- (a) Switch on. Measure and record in the table the current I in the circuit and the p.d. V across the section of resistance wire **AB**. Switch off.
- (b) Record the length l of the resistance wire **AB**.
- (c) Calculate the resistance R of the section of wire **AB** using the equation

$$R = \frac{V}{I}.$$

Record this value of R in the table.

- (d) Complete the column headings for each of the l , I , V and R columns of the table.
- (e) Repeat steps (a) – (c) with the voltmeter connected across section **AC** of the resistance wire.
- (f) Repeat steps (a) – (c) with the voltmeter connected across section **AD** of the resistance wire.
- (g) Use your results to predict the resistance of a 1.50 m length of the same wire. Show your working.

- 3 In this experiment you are to investigate the period of oscillation of a mass attached between two springs.

Record all your observations on page 5 of your Answer Booklet.

Carry out the following instructions, referring to Fig. 3.1. The apparatus has been set up for you.

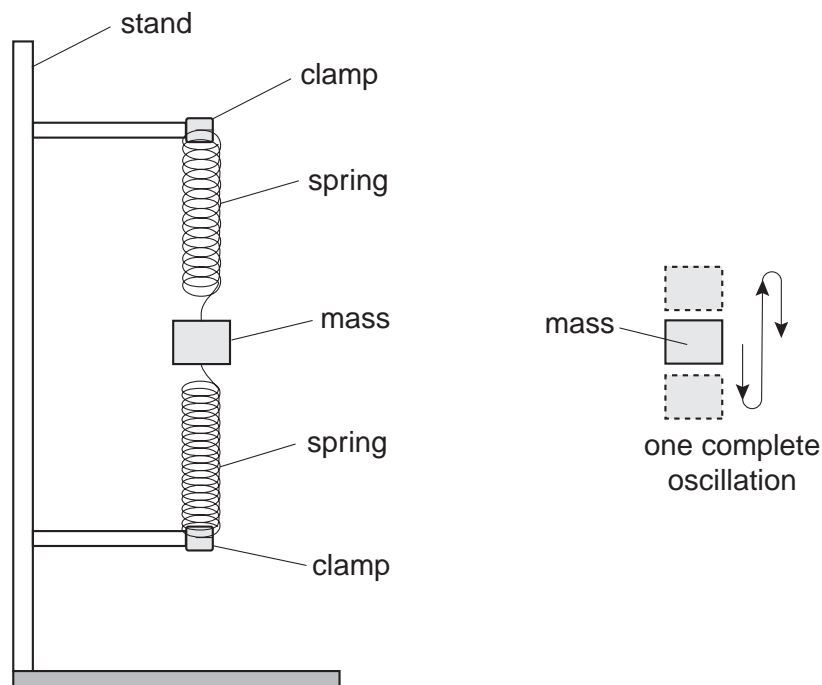

Fig. 3.1

You are provided with a mass m of 400 g attached between two springs.

- Displace the mass a **small** distance downwards and release it so that it oscillates. Record the time t_1 taken for 10 complete oscillations of the mass. Also record the time t_2 taken for another 10 complete oscillations of the mass.
- Calculate t , the average value of t_1 and t_2 .
- Calculate the period T of the oscillations. T is the time for one complete oscillation.
- Calculate the value of $\frac{T}{m}$.
- Repeat steps (a) – (d) using values for m of 300 g and 200 g.
- Complete the final column heading in the table.
- A student suggests that T should be directly proportional to m . State with a reason whether or not your results support this suggestion.
- In the experiment you have just done, the mass oscillates rapidly so that it is difficult to take the times accurately. The instructions in the question included methods of improving the accuracy of the value obtained for the period T . Describe briefly one of these methods and any calculation involved to obtain the T value.

- 4 In this experiment you will investigate the refraction of light through a transparent block.

Record all your observations and answers on page 7 of your Answer Booklet. You are supplied with three ray trace sheets.

Carry out the following instructions, referring to Figs. 4.1, 4.2 and 4.3.

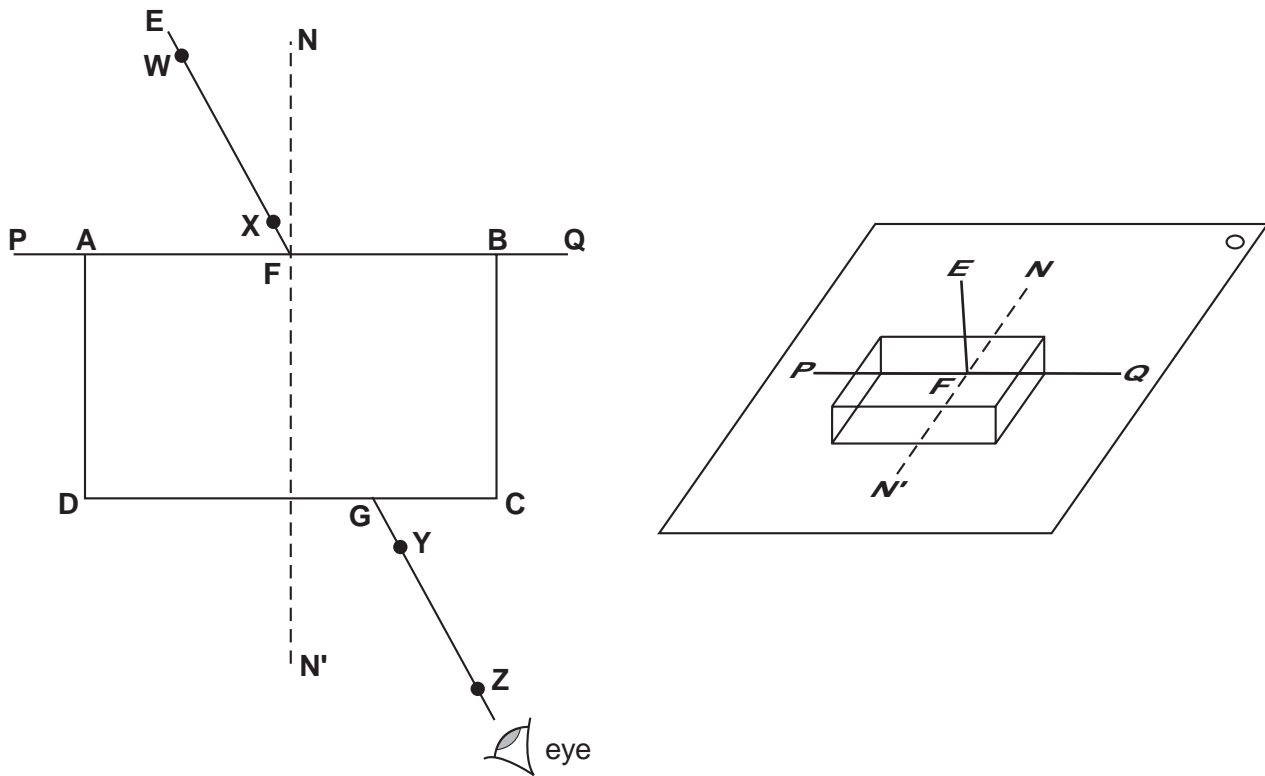

Fig. 4.1

- Place the transparent block with its largest face down on one of the ray trace sheets as shown in Fig. 4.1. One of the longest sides is to be along line **PQ**.
- Draw round the block and label the corners **A**, **B**, **C** and **D**. Remove the block.
- Place the ray trace sheet on the pin board and push a pin **X** into the paper on line **EF** close to line **AB**. Push another pin **W** into line **EF** some distance away from line **AB**.
- Replace the block on the ray trace sheet.
- View the images of pins **W** and **X** through the block. Place two pins **Y** and **Z** between your eye and the block so that **Y**, **Z** and the images of **W** and **X** appear exactly one behind the other.
- Label the positions of pins **W**, **X**, **Y** and **Z** on the ray trace sheet. Remove the pins and the block. Using a rule, draw a line joining **Z** and **Y** and continue the line to meet the line **CD** at a point, which you should label **G**.
- Draw a line to join the points **F** and **G**.
- Measure and record the angle of refraction r between line **FG** and the normal **NN'**.

- (i) Place the block on the second ray trace sheet so that one of its longest sides is along line **PQ** but with the largest face vertical (as shown in Fig. 4.2). Label the corners **A**, **B**, **C** and **D**.

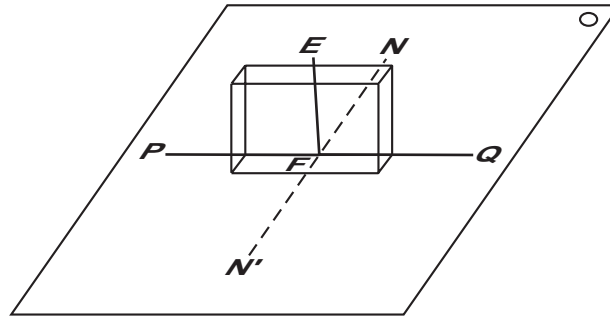

Fig. 4.2

- (j) Repeat steps (b) – (h).
- (k) Place the block on the third ray trace sheet with the largest face down so that one of its shorter sides is along the line **PQ**. One corner should be about 1 cm to the left of point **F**, as shown in Fig. 4.3. Label the corners **A**, **B**, **C** and **D**.

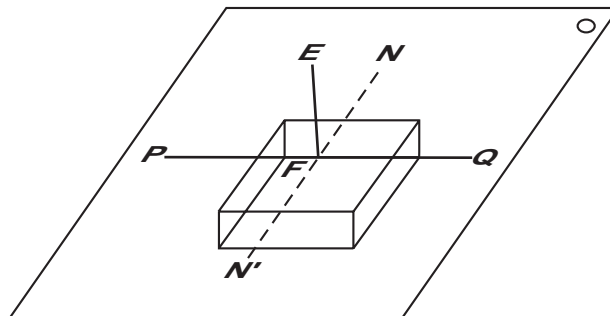

Fig. 4.3

- (l) Repeat steps (b) – (h).
- (m) Within the limits of experimental error, what do you conclude about the effect on the angle of refraction r of increasing the length of the ray within the block?

Tie your ray trace sheets into your Answer Booklet.

BLANK PAGE

Permission to reproduce items where third-party owned material protected by copyright is included has been sought and cleared where possible. Every reasonable effort has been made by the publisher (UCLES) to trace copyright holders, but if any items requiring clearance have unwittingly been included, the publisher will be pleased to make amends at the earliest possible opportunity.

University of Cambridge International Examinations is part of the University of Cambridge Local Examinations Syndicate (UCLES), which is itself a department of the University of Cambridge.

Centre Number	Candidate Number	Name
---------------	------------------	------

UNIVERSITY OF CAMBRIDGE INTERNATIONAL EXAMINATIONS
International General Certificate of Secondary Education

PHYSICS **0625/05**

Paper 5 Practical Test May/June 2005

ANSWER BOOKLET **1 hour 15 minutes**

READ THESE INSTRUCTIONS FIRST

Write your Centre number, candidate number and name on all the work you hand in.
Write in dark blue or black pen in the spaces provided on this Answer Booklet.
You may use a soft pencil for any diagrams, graphs or rough working.
Do not use staples, paper clips, highlighters, glue or correction fluid.
All of your answers should be written in this Answer Booklet: scrap paper must **not** be used.

Answer **all** questions.
Graph paper is provided in this Answer Booklet. Additional sheets of graph paper should be used only if it is necessary to do so.
At the end of the examination, fasten any additional answer paper used securely to this Answer Booklet.

If you have been given a label, look at the details. If any details are incorrect or missing, please fill in your correct details in the space given at the top of this page.

Stick your personal label here, if provided.

For Examiner's Use	
1	
2	
3	
4	
Total	

1 (a) (i) Record of temperature of the cold water [1]

(ii) – (v)

$\theta /$	$V /$
	0

[3]

(vi)

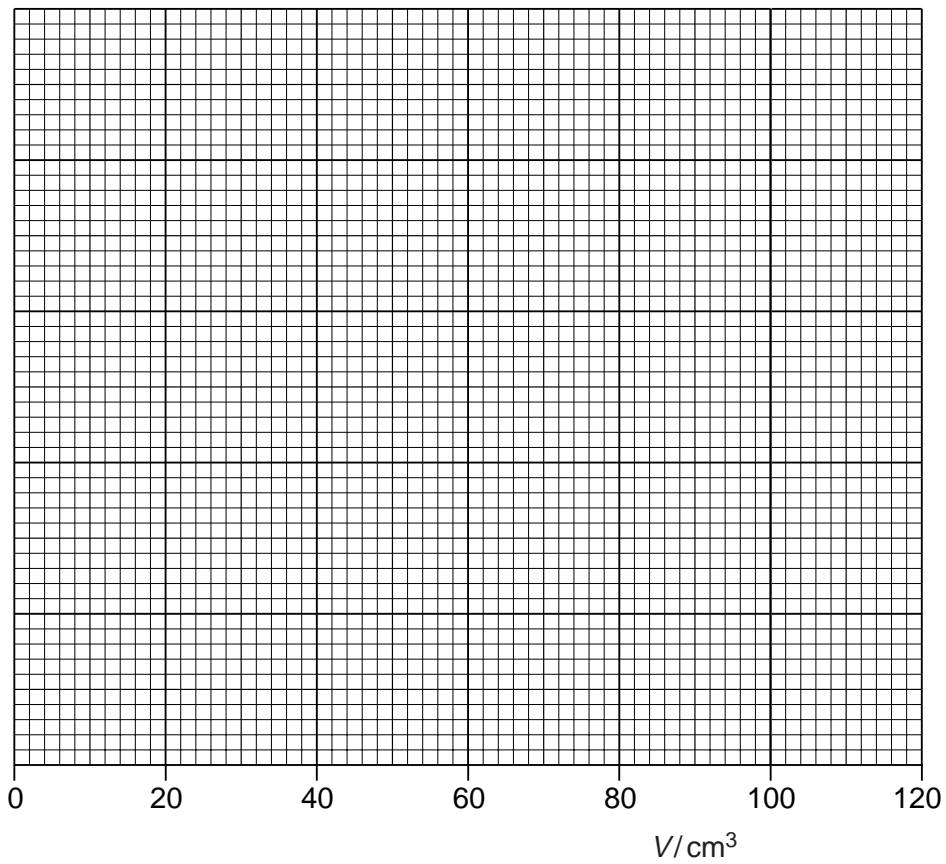

[5]

(b) A practical reason why the student's experimental line differed from the theoretical line

.....

.....

..... [1]

2 (a) – (f)

voltmeter connected across	$I/$	$I/$	$V/$	$R/$
AB				
AC				
AD				

[8]

(g) Working

Predicted resistance

[2]

3 (a) – (f)

m/g	t_1/s	t_2/s	t/s	T/s	$\frac{T}{m}$
400					
300					
200					

[6]

(g) Statement

Reason

.....

..... [2]

(h) Description

.....

..... [2]

Tie your ray trace sheets in here.

[5]

For
Examiner's
Use

4 (h) value of r

(j) value of r

(l) value of r

[4]

(m) Within the limits of experimental error,

.....

..... [1]

BLANK PAGE

Permission to reproduce items where third-party owned material protected by copyright is included has been sought and cleared where possible. Every reasonable effort has been made by the publisher (UCLES) to trace copyright holders, but if any items requiring clearance have unwittingly been included, the publisher will be pleased to make amends at the earliest possible opportunity.

University of Cambridge International Examinations is part of the University of Cambridge Local Examinations Syndicate (UCLES), which is itself a department of the University of Cambridge.