

- 1 Christa had a music lesson every week for one year.
Each of the 52 lessons lasted for 45 minutes.

Calculate the total time that Christa spent in music lessons.
Give your time in hours.

Answer h [2]

- 2 Three of the vertices of a parallelogram are at (4, 12), (8, 4) and (16, 16).

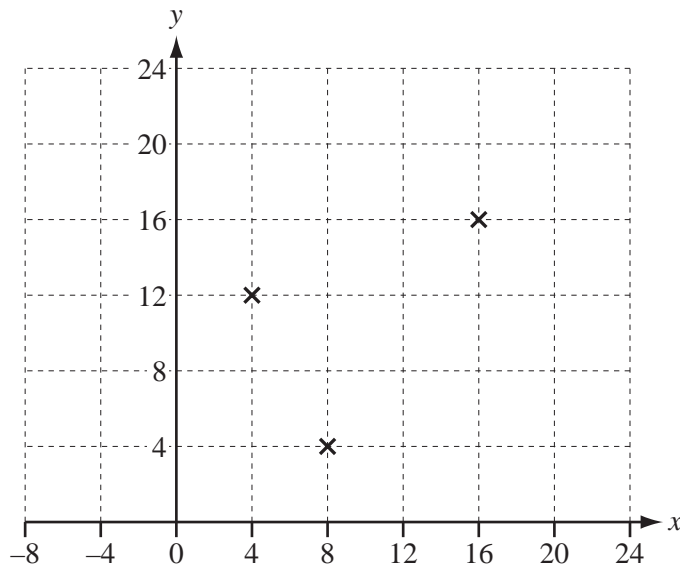

Write down the co-ordinates of two possible positions of the fourth vertex.

Answer (..... ,) and (..... ,) [2]

- 3 Solve the equation $1 + 2x = -15$.

Answer $x =$ [2]

- 4 Write the following in order of size, smallest first.

$\cos 100^\circ$ $\tan 100^\circ$ $\frac{1}{100}$ $100^{-0.1}$

Answer < < < [2]

5 Write

(a) 60 square metres in square centimetres,

Answer(a) cm² [1]

(b) 22 metres per second in kilometres per hour.

Answer(b) km/h [2]

6 In 2012 the cost of a ticket to an arts festival was \$30.
This was 20% more than the ticket cost in 2011.

Calculate the cost of the ticket in 2011.

Answer \$ [3]

7 The solutions of the equation $x^2 - 6x + d = 0$ are both integers.
 d is a prime number.

Find d .

Answer $d =$ [3]

- 8 m varies directly as the cube of x .
 $m = 200$ when $x = 2$.

Find m when $x = 0.4$.

Answer $m = \dots\dots\dots$ [3]

- 9 (a) Expand and simplify $(a + b)^2$.

Answer(a) $\dots\dots\dots$ [2]

- (b) Find the value of $a^2 + b^2$ when $a + b = 6$ and $ab = 7$.

Answer(b) $\dots\dots\dots$ [1]

10

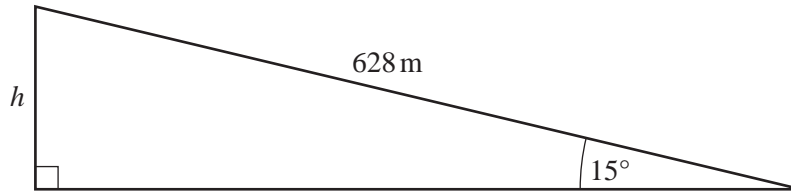
NOT TO
SCALE

Calculate the length h .
Give your answer correct to 2 significant figures.

Answer $h = \dots\dots\dots$ m [3]

11 $\mathbf{A} = \begin{pmatrix} 3 & -1 \\ 4 & 2 \end{pmatrix}$ $\mathbf{I} = \begin{pmatrix} 1 & 0 \\ 0 & 1 \end{pmatrix}$

Work out the following.

(a) \mathbf{AI}

Answer(a) $\mathbf{AI} = \dots\dots\dots$ [1]

(b) \mathbf{A}^{-1}

Answer(b) $\mathbf{A}^{-1} = \dots\dots\dots$ [2]

12 Write the answer to the following calculations in standard form.

(a) $600 \div 8000$

Answer(a) [2]

(b) $10^8 - 7 \times 10^6$

Answer(b) [2]

13

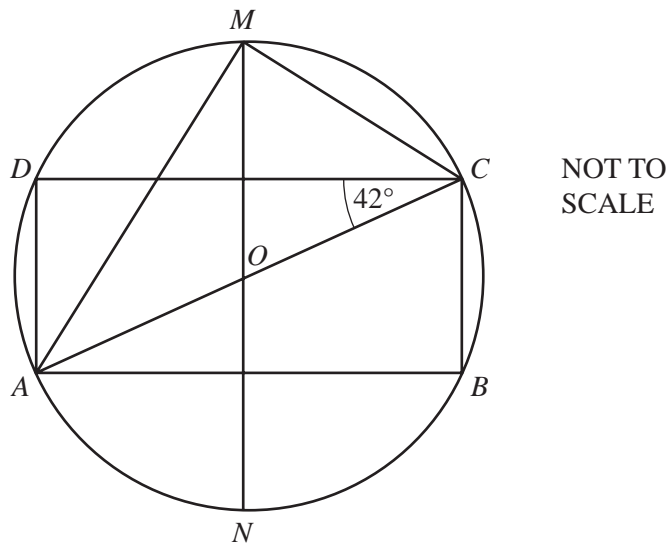

The vertices of the rectangle $ABCD$ lie on a circle centre O .
 MN is a line of symmetry of the rectangle.
 AC is a diameter of the circle and angle $ACD = 42^\circ$.

Calculate

(a) angle CAM ,

Answer(a) Angle $CAM =$ [2]

(b) angle DCM .

Answer(b) Angle $DCM =$ [2]

14 (a) Simplify $(64q^{-2})^{\frac{1}{2}}$.

Answer(a) [2]

(b) $5^7 \div 5^9 = p^2$

Find p .

Answer(b) $p =$ [2]

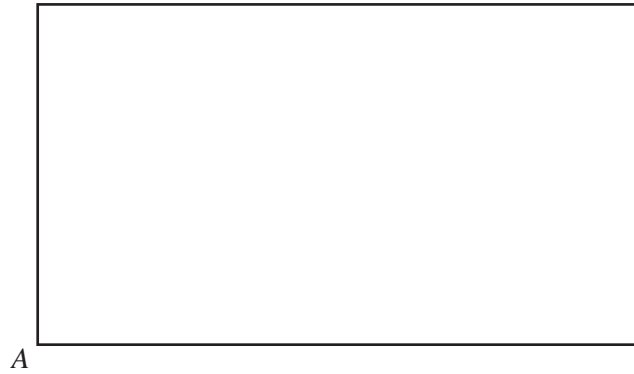

- (a) Construct the locus of all the points which are 3 cm from vertex *A* **and** outside the rectangle. [2]
- (b) Construct, **using a straight edge and compasses only**, one of the lines of symmetry of the rectangle. [2]
-

- 16 The diagram shows the entrance to a tunnel.
The circular arc has a radius of 3 m and centre O .
 AB is horizontal and angle $AOB = 120^\circ$.

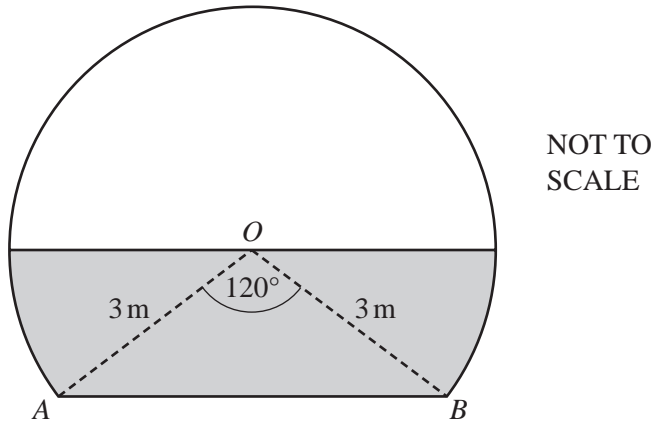

During a storm the tunnel filled with water, to the level shown by the shaded area in the diagram.

- (a) Calculate the shaded area.

Answer(a) m² [4]

- (b) The tunnel is 50 m long.

Calculate the volume of water in the tunnel.

Answer(b) m³ [1]

17 (p, q) is the image of the point (x, y) under this combined transformation.

$$\begin{pmatrix} p \\ q \end{pmatrix} = \begin{pmatrix} -1 & 0 \\ 0 & 1 \end{pmatrix} \begin{pmatrix} x \\ y \end{pmatrix} + \begin{pmatrix} 3 \\ 2 \end{pmatrix}$$

(a) Draw the image of the triangle under the combined transformation.

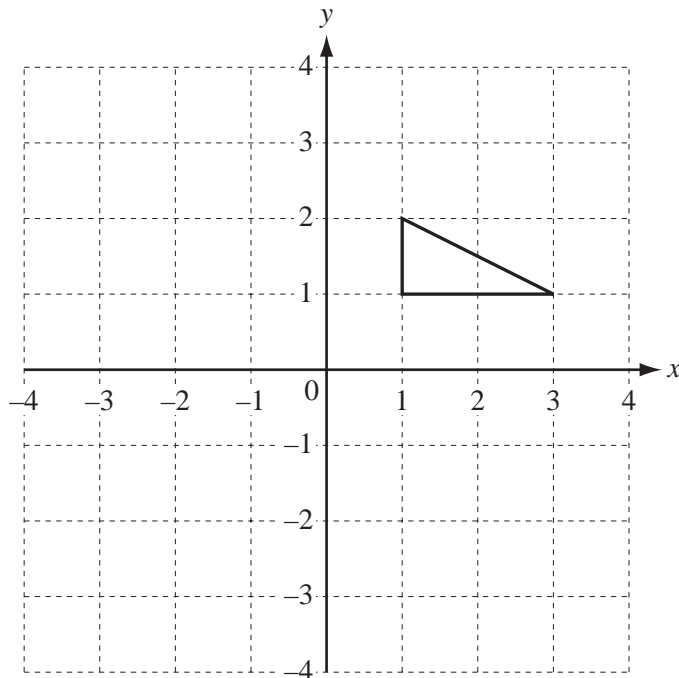

[3]

(b) Describe fully the **single** transformation represented by $\begin{pmatrix} -1 & 0 \\ 0 & 1 \end{pmatrix}$.

Answer (b) [2]

- 18 A gardener measured the lengths of 50 green beans from his garden. The results have been used to draw this cumulative frequency diagram.

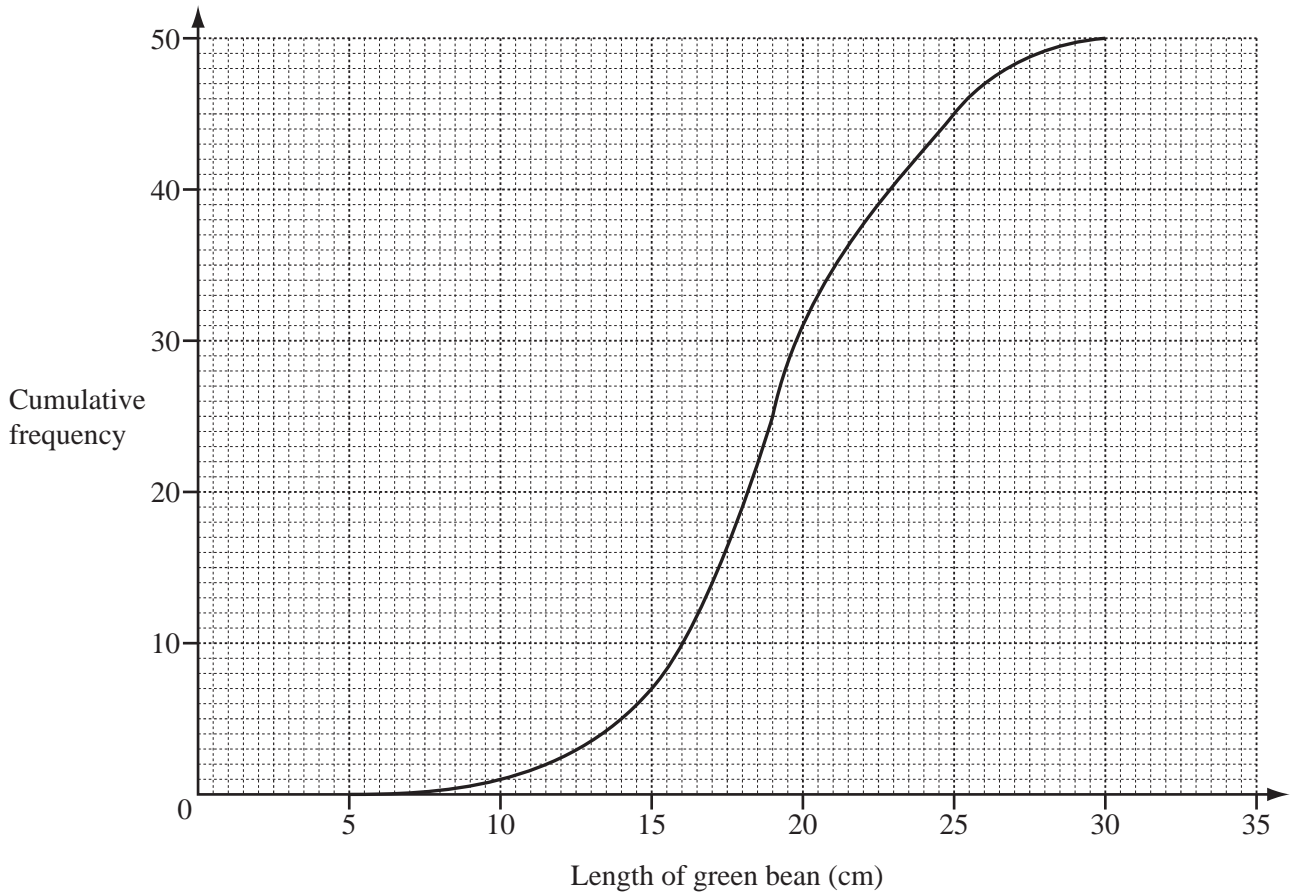

Work out

- (a) the median,

Answer(a) cm [1]

- (b) the number of green beans that are longer than 26 cm,

Answer(b) [2]

- (c) the inter-quartile range,

Answer(c) cm [2]

- (d) the probability that a green bean chosen at random is more than 14 cm long.

Answer(d) [2]

Question 19 is printed on the next page.

19 $f(x) = 2x + 3$ $g(x) = x^2$

(a) Find $fg(6)$.

Answer(a) [2]

(b) Solve the equation $gf(x) = 100$.

Answer(b) $x = \dots\dots\dots$ or $x = \dots\dots\dots$ [3]

(c) Find $f^{-1}(x)$.

Answer(c) $f^{-1}(x) = \dots\dots\dots$ [2]

(d) Find $ff^{-1}(5)$.

Answer(d) [1]

Permission to reproduce items where third-party owned material protected by copyright is included has been sought and cleared where possible. Every reasonable effort has been made by the publisher (UCLES) to trace copyright holders, but if any items requiring clearance have unwittingly been included the publisher will be pleased to make amends at the earliest possible opportunity.

University of Cambridge International Examinations is part of the Cambridge Assessment Group. Cambridge Assessment is the brand name of University of Cambridge Local Examinations Syndicate (UCLES), which is itself a department of the University of Cambridge.