

UNIVERSITY OF CAMBRIDGE INTERNATIONAL EXAMINATIONS
International General Certificate of Secondary Education

CHEMISTRY

0620/01

Paper 1 Multiple Choice

May/June 2004

45 minutes

Additional Materials: Multiple Choice Answer Sheet
Soft clean eraser
Soft pencil (type B or HB is recommended)

READ THESE INSTRUCTIONS FIRST

Write in soft pencil.

Do not use staples, paper clips, highlighters, glue or correction fluid.

Write your name, Centre number and candidate number on the answer sheet in the spaces provided unless this has been done for you.

There are **forty** questions on this paper. Answer **all** questions.

For each question there are four possible answers **A, B, C,** and **D**. Choose the **one** you consider correct and record your choice in **soft pencil** on the separate answer sheet.

Read the instructions on the answer sheet very carefully.

Each correct answer will score one mark. A mark will not be deducted for a wrong answer.

Any rough working should be done in this booklet.

A copy of the Periodic Table is printed on page 16.

You may use a calculator.

This document consists of **16** printed pages.



- 1 Some students are asked to describe differences between gases and liquids.

Three of their suggestions are:

1	gas molecules are further apart;
2	gas molecules are smaller;
3	liquid molecules vibrate around fixed positions.

Which suggestions are correct?

- A 1 only B 2 only C 3 only D 1, 2 and 3
- 2 A coloured liquid vaporises easily at room temperature. Some of the liquid is placed at the bottom of a sealed gas jar.

Which diagram shows the appearance of the jar after several hours?

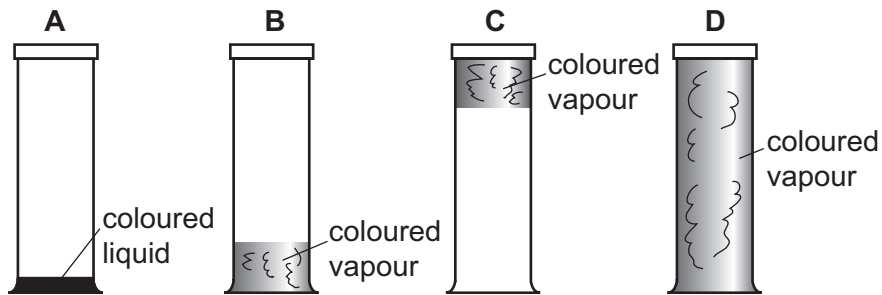

- 3 Measurements are made on some pure water.

its boiling point, b.p.

its freezing point, f.p.

its pH

Sodium chloride is now dissolved in the water and the measurements repeated.

Which measured values change?

	b.p.	f.p.	pH
A	✓	✓	✓
B	✓	✓	x
C	x	x	✓
D	x	x	x

- 4 The diagram shows a chromatogram obtained from three sweets, X, Y and Z.

<ul style="list-style-type: none"> ● yellow ● red 	<ul style="list-style-type: none"> ● red ● yellow 	<ul style="list-style-type: none"> ● red ● yellow ● red
sweet X	sweet Y	sweet Z

How many different red dyes are present in the sweets?

- A** 1 **B** 2 **C** 3 **D** 4
- 5 Which properties does a Group VI element have?

	forms covalent bonds	forms ionic bonds	conducts electricity when solid
A	✓	✓	✓
B	x	✓	✓
C	✓	✓	x
D	✓	x	x

6 The electronic structure of an element is shown.

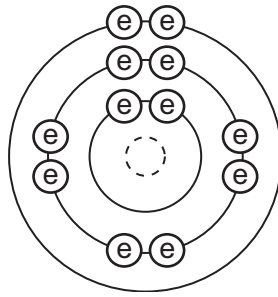

key

⊙ electron

⊖ nucleus

Which diagram shows the electronic structure of another element in the same group in the Periodic Table?

A

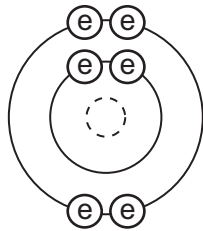

B

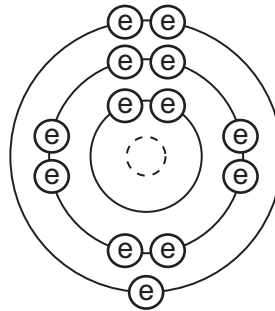

C

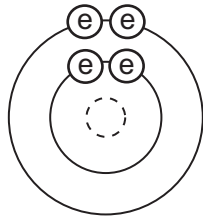

D

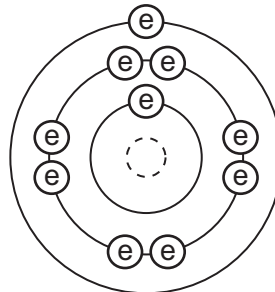

7 In the diagrams, circles of different sizes represent atoms of different elements.

Which diagram can represent hydrogen chloride gas?

A

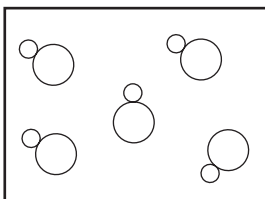

B

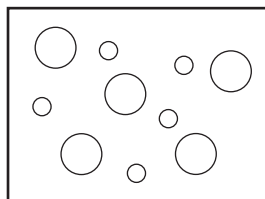

C

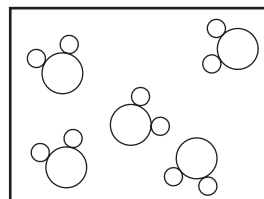

D

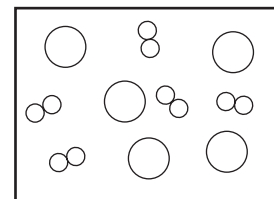

- 8 How many electrons are shared between the atoms in a molecule of methane, CH₄, and in a molecule of water, H₂O?

	methane	water
A	4	2
B	4	4
C	8	2
D	8	4

- 9 The oxide Pb₃O₄ reacts with dilute nitric acid to form lead(II) nitrate, lead(IV) oxide and another product.

What is the equation for this reaction?

- A** $\text{Pb}_3\text{O}_4 + 4\text{HNO}_3 \rightarrow 2\text{Pb}(\text{NO}_3)_2 + \text{PbO}_2 + 2\text{H}_2\text{O}$
- B** $\text{Pb}_3\text{O}_4 + 2\text{HNO}_3 \rightarrow 2\text{PbNO}_3 + \text{PbO}_4 + \text{H}_2$
- C** $\text{Pb}_3\text{O}_4 + 4\text{HNO}_3 \rightarrow \text{Pb}(\text{NO}_3)_4 + 2\text{PbO} + 2\text{H}_2\text{O}$
- D** $2\text{Pb}_3\text{O}_4 + 2\text{HNO}_3 \rightarrow 2\text{Pb}_2\text{NO}_3 + 2\text{PbO}_2 + \text{H}_2$

- 10 The compound ethyl mercaptan, C₂H₅SH, has a very unpleasant smell.

What is its relative molecular mass?

- A** 34 **B** 50 **C** 61 **D** 62

- 11 The proton number of helium is 2.

What information does this give about helium?

- A** Its atom has two electrons.
- B** Its atom is twice as heavy as a hydrogen atom.
- C** It is a Group II element.
- D** Its molecule has two atoms.

12 In the circuit shown the bulb does not light.

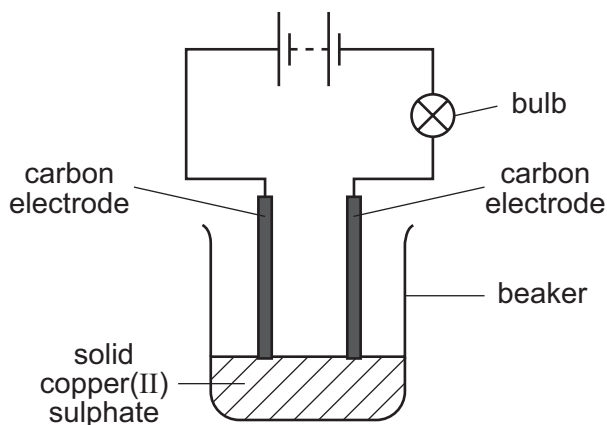

Which change would cause the bulb to light?

- A add more solid copper(II) sulphate to the beaker
- B add water to dissolve the copper(II) sulphate
- C replace the carbon electrodes with copper electrodes
- D reverse the connections to the electrodes

13 The following electrolysis circuit is set up, using inert electrodes **P**, **Q**, **R** and **S**.

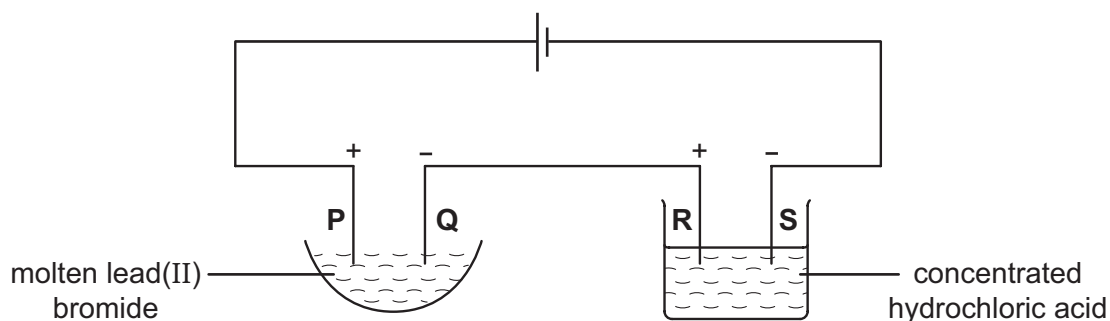

At which of the electrodes is a Group VII element produced?

- A P only
- B P and R
- C Q only
- D Q and S

14 When it is used as a fuel, hydrogen combines with substance **X**.

What is **X**?

- A carbon
- B methane
- C nitrogen
- D oxygen

- 15 The table compares the strengths of the bonds for reactions of the type below.

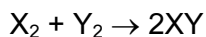

Which reaction is most exothermic?

	bonds in X_2	bonds in Y_2	bonds in XY
A	strong	strong	strong
B	strong	strong	weak
C	weak	weak	strong
D	weak	weak	weak

- 16 In an experiment, copper(II) oxide is changed to copper by a gas **X**.

What happens to the copper(II) oxide and what is **X**?

	copper(II) oxide	gas X
A	oxidised	carbon dioxide
B	oxidised	carbon monoxide
C	reduced	carbon dioxide
D	reduced	carbon monoxide

- 17 In an experiment, a 2g lump of zinc and 2g of powdered zinc are added separately to equal volumes of dilute sulphuric acid.

The solid line on the graph shows the volume of gas given off when the 2g lump is used.

Which dotted line is obtained when the zinc is powdered?

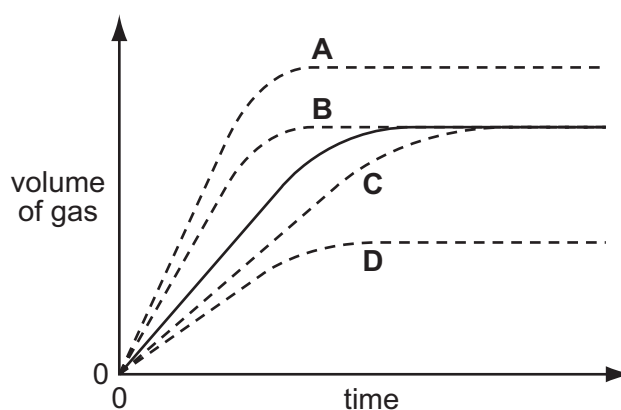

18 Which process is endothermic?

- A adding water to anhydrous copper(II) sulphate
- B burning magnesium to make the oxide
- C heating water to make steam
- D neutralising acidic industrial waste

19 An aqueous solution contains either aluminium sulphate or zinc sulphate.

Which aqueous reagent can be used to confirm which salt is present?

- A ammonia
- B barium chloride
- C sodium hydroxide
- D sulphuric acid

20 Compound **X**

- does not dissolve in water,
- does not react with water,
- is used to control soil acidity.

What is **X**?

- A calcium carbonate
- B calcium chloride
- C calcium hydroxide
- D calcium oxide

21 Aqueous sodium hydroxide is added to two different solutions with the results shown.

green precipitate formed

X

Y

light blue precipitate formed

Which cation is present in **X** and in **Y**?

	X	Y
A	ammonium	iron(II)
B	copper(II)	ammonium
C	iron(II)	copper(II)
D	iron(II)	ammonium

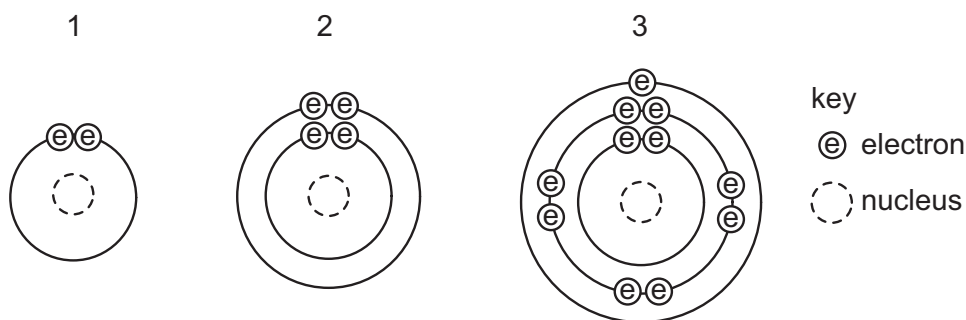
22 The diagrams show the arrangement of electrons in three different atoms.



Which atoms are metals?

- A** 1 and 2 only **B** 1 and 3 only **C** 2 and 3 only **D** 1, 2 and 3

23 Which property do all metals have?

- A** They are hard.
B They conduct electricity.
C They form acidic oxides.
D They react with water.

24 The diagram shows a light bulb.

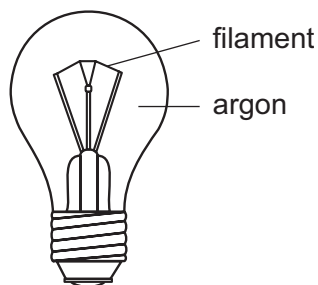

Why is argon used instead of air in the light bulb?

- A** Argon is a good conductor of electricity.
B Argon is more reactive than air.
C The filament glows more brightly.
D The filament lasts for a longer time.

25 Which element is likely to be a transition metal?

	melting point in °C	density in g/cm ³	colour of oxide
A	98	1.0	white
B	328	11.3	yellow
C	651	1.7	white
D	1240	7.4	black

26 Three metals are extracted as shown in the table.

metal	method of extraction
X	electrolyse molten metal oxide
Y	heat metal oxide with carbon
Z	occurs naturally as the metal

What is the order of reactivity of the metals?

	most reactive	—————>	least reactive
A	X	Y	Z
B	X	Z	Y
C	Y	Z	X
D	Z	X	Y

27 Haematite is reduced to iron in the blast furnace.



What is **X**?

- A** carbon
- B** carbon dioxide
- C** hydrogen
- D** oxygen

28 Which object is **least** likely to contain aluminium?

- A** a bicycle frame
- B** a hammer
- C** a saucepan
- D** an aeroplane body

- 29 A sample of clean, dry air is passed over hot copper until **all** the oxygen in the air reacts with the copper.

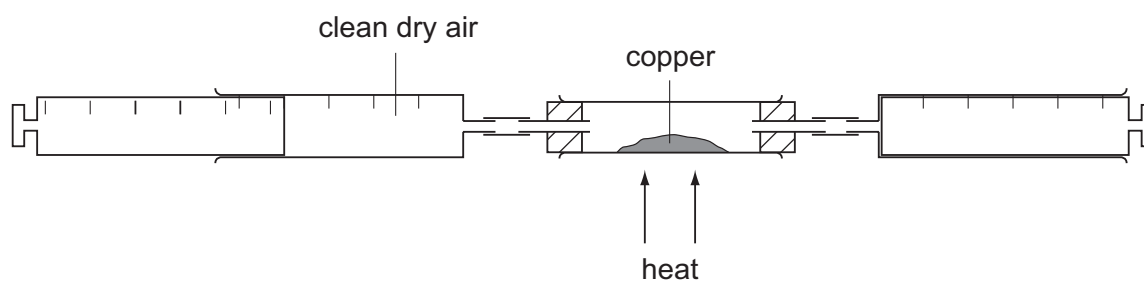

The volume of air decreases by 30 cm^3 .

What was the starting volume of the sample of air?

- A 60 cm^3 B 100 cm^3 C 150 cm^3 D 300 cm^3
- 30 The pH of some aqueous sodium hydroxide is measured. The solution is then distilled as shown.

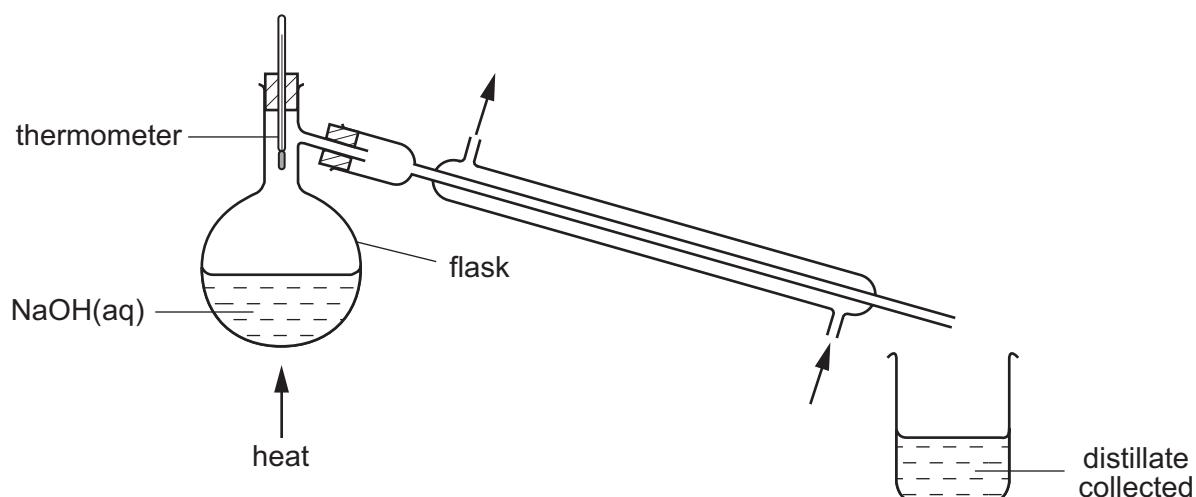

How do the pH values of the distillate and of the solution left in the flask compare with the original?

	pH of the distillate	pH of the solution left in the flask
A	higher	higher
B	higher	lower
C	lower	higher
D	lower	lower

- 31 Which two gases produced from the burning of petrol in motor vehicles contribute to the formation of acid rain?
- A** carbon dioxide and carbon monoxide
B carbon monoxide and sulphur dioxide
C carbon monoxide and nitrogen dioxide
D nitrogen dioxide and sulphur dioxide
- 32 An old railway carriage is being restored. Metal strips are secured on to the outside of the wooden carriage by means of screws. After a few weeks open to the wind and rain, the screws are heavily corroded but the metal strips are not.

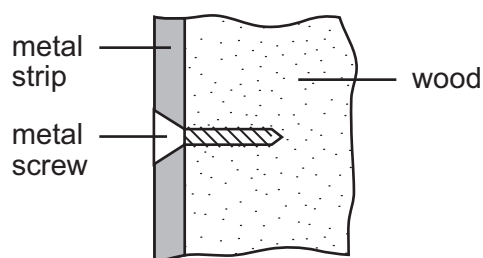

Aluminium is more reactive than both steel and copper.

Which two metals would give this result?

	screws	strips
A	aluminium	steel
B	copper	aluminium
C	copper	steel
D	steel	aluminium

- 33 The diagram shows how oxygen is used in welding.

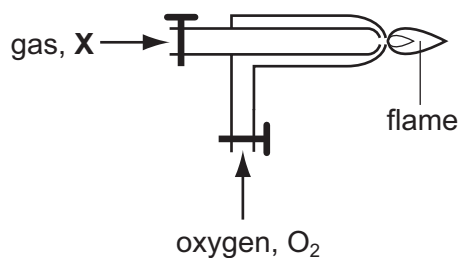

What is gas **X**?

- A** acetylene
B argon
C neon
D nitrogen

34 The diagrams show the growth of four plants.

before treatment

after treatment

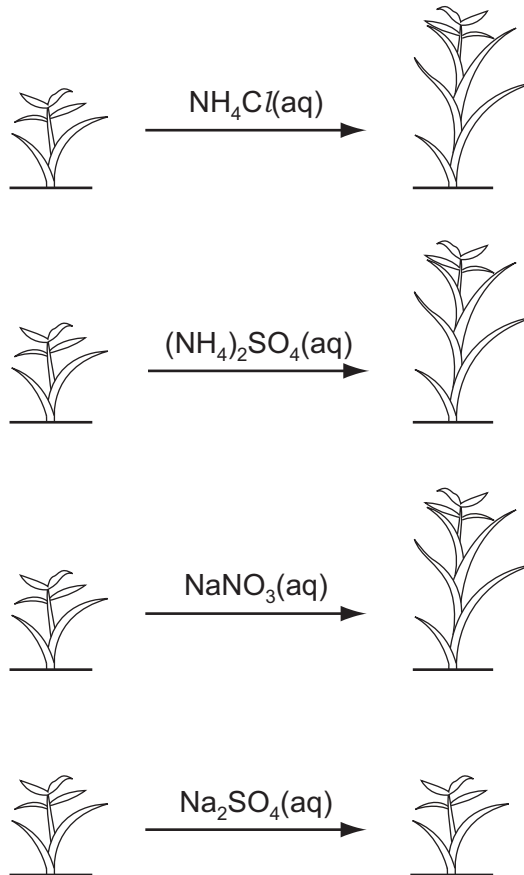

Which element is acting as a fertiliser?

A Cl

B N

C Na

D S

35 Gas is released in all of the examples below.



acid rain on a limestone statue



a candle burning



a dog panting

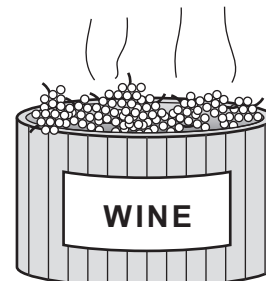

fermenting grapes

Which gas do they **all** produce?

- A carbon dioxide
- B hydrogen
- C methane
- D oxygen

36 What is formed when calcium carbonate is heated?

- A calcium and carbon
- B calcium and carbon dioxide
- C calcium oxide and carbon
- D calcium oxide and carbon dioxide

37 Which compound contains three elements?

- A ethanol
- B ethene
- C methane
- D poly(ethene)

38 Four fractions obtained from crude oil (petroleum) are listed below.

Which fraction is paired with a correct use?

	fraction	use
A	bitumen	making waxes
B	diesel	fuel for aircraft
C	lubricating	making roads
D	paraffin	fuel for oil stoves

39 The structures of three compounds are shown.

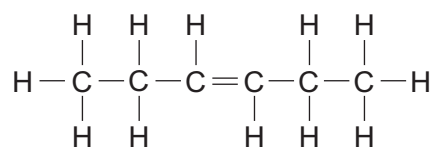
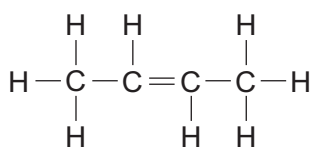
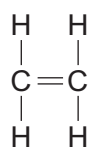

Why do these substances all belong to the same homologous series?

- A** They all contain an even number of carbon atoms.
- B** They all contain the same functional group.
- C** They are all hydrocarbons.
- D** They are all saturated.

40 The table shows some suggested reactions involving ethanol.

Which suggestions about the reactants and products are correct?

reaction	reactants	products
A	ethanol and oxygen	carbon dioxide and water
B	ethene and steam	ethanol and hydrogen
C	glucose and oxygen	ethanol and carbon dioxide
D	glucose and water	ethanol and oxygen

DATA SHEET
The Periodic Table of the Elements

		Group																							
I	II	III	IV	V	VI	VII	O																		
7 Li Lithium 3	9 Be Beryllium 4	<div style="display: flex; justify-content: center; align-items: center;"> <div style="border: 1px solid black; padding: 2px; margin-right: 10px;">1 H Hydrogen 1</div> </div>										11 B Boron 5	12 C Carbon 6	14 N Nitrogen 7	16 O Oxygen 8	19 F Fluorine 9	20 Ne Neon 10								
23 Na Sodium 11	24 Mg Magnesium 12											27 Al Aluminium 13	28 Si Silicon 14	31 P Phosphorus 15	32 S Sulphur 16	35.5 Cl Chlorine 17	40 Ar Argon 18								
39 K Potassium 19	40 Ca Calcium 20	45 Sc Scandium 21	48 Ti Titanium 22	51 V Vanadium 23	52 Cr Chromium 24	55 Mn Manganese 25	56 Fe Iron 26	59 Co Cobalt 27	59 Ni Nickel 28	64 Cu Copper 29	65 Zn Zinc 30	70 Ga Gallium 31	73 Ge Germanium 32	75 As Arsenic 33	79 Se Selenium 34	80 Br Bromine 35	84 Kr Krypton 36								
85 Rb Rubidium 37	88 Sr Strontium 38	89 Y Yttrium 39	91 Zr Zirconium 40	93 Nb Niobium 41	96 Mo Molybdenum 42	101 Ru Ruthenium 44	106 Pd Palladium 46	108 Ag Silver 47	112 Cd Cadmium 48	115 In Indium 49	119 Sn Tin 50	122 Sb Antimony 51	128 Te Tellurium 52	127 I Iodine 53	131 Xe Xenon 54										
133 Cs Caesium 55	137 Ba Barium 56	139 La Lanthanum 57	178 Hf Hafnium 72	181 Ta Tantalum 73	184 W Tungsten 74	190 Os Osmium 76	195 Pt Platinum 78	197 Au Gold 79	201 Hg Mercury 80	204 Tl Thallium 81	207 Pb Lead 82	209 Bi Bismuth 83	210 Po Polonium 84	210 At Astatine 85	222 Rn Radon 86										
87 Fr Francium	88 Ra Radium	227 Ac Actinium											140 Ce Cerium 58	141 Pr Praseodymium 59	144 Nd Neodymium 60	150 Sm Samarium 62	152 Eu Europium 63	157 Gd Gadolinium 64	159 Tb Terbium 65	162 Dy Dysprosium 66	165 Ho Holmium 67	167 Er Erbium 68	169 Tm Thulium 69	173 Yb Ytterbium 70	175 Lu Lutetium 71
				232 Th Thorium 90	238 U Uranium 92	93 Np Neptunium 93	94 Pu Plutonium 94	95 Am Americium 95	96 Cm Curium 96	97 Bk Berkelium 97	98 Cf Californium 98	99 Es Einsteinium 99	100 Fm Fermium 100	101 Md Mendelevium 101	102 No Nobelium 102	103 Lr Lawrencium 103									

*58-71 Lanthanoid series
90-103 Actinoid series

a **X** b
 Key a = relative atomic mass X = atomic symbol b = proton (atomic) number

The volume of one mole of any gas is 24 dm³ at room temperature and pressure (r.t.p.).