



UNIVERSITY OF CAMBRIDGE INTERNATIONAL EXAMINATIONS  
International General Certificate of Secondary Education

CANDIDATE  
NAME

CENTRE  
NUMBER

--	--	--	--	--

CANDIDATE  
NUMBER

--	--	--	--	--

\* 1 3 8 6 1 4 9 9 2 5 \*

**BIOLOGY**

**0610/22**

Paper 2 Core

**October/November 2010**

**1 hour 15 minutes**

Candidates answer on the Question Paper.

No Additional Materials are required.

**READ THESE INSTRUCTIONS FIRST**

Write your Centre number, candidate number and name on all the work you hand in.

Write in dark blue or black pen.

You may use a pencil for any diagrams or graphs.

Do not use staples, paper clips, highlighters, glue or correction fluid.

**DO NOT WRITE IN ANY BARCODES.**

Answer **all** questions.

At the end of the examination, fasten all your work securely together.

The number of marks is given in brackets [ ] at the end of each question or part question.

For Examiner's Use	
1	
2	
3	
4	
5	
6	
7	
8	
9	
<b>Total</b>	

This document consists of **16** printed pages.



1 Fig. 1.1 shows part of the human digestive system.

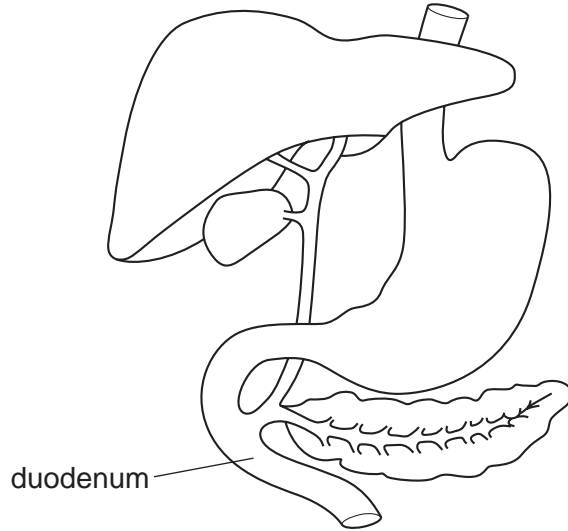

Fig. 1.1

(a) On Fig. 1.1, label the gall bladder, the oesophagus and the pancreas.

Use label lines and the words 'gall bladder' 'oesophagus' and 'pancreas' on Fig. 1.1. [3]

(b) Enzymes are needed to digest the food we eat.

(i) Define the term *enzyme*.

.....

.....

..... [2]

(ii) Fig. 1.2 shows the activity of three digestive enzymes in solutions of different pH.

For  
Examiner's  
Use

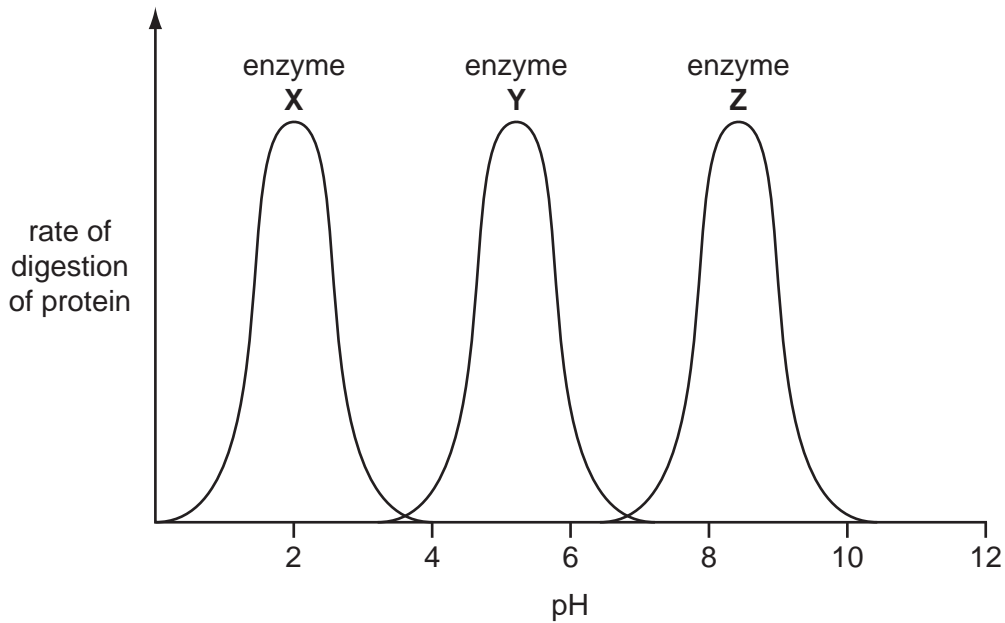

Fig. 1.2

Suggest and explain which one of the three enzymes is most likely to be active in the stomach.

.....  
 .....  
 ..... [2]

(iii) Amylase is a digestive enzyme found in the duodenum.

Name the food component that amylase digests and name the end product of this digestion.

*food component* .....

*end product* ..... [2]

(c) A liquid, produced by the liver, does not contain any digestive enzymes. Name this liquid and explain how it helps in digestion in the duodenum.

.....  
 .....  
 .....  
 .....  
 ..... [3]

[Total: 12]

2 (a) Fig. 2.1 shows a bird.

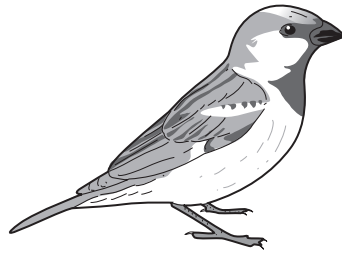

Fig. 2.1

Describe two external features that occur in birds but do **not** occur in other vertebrates.

1. ....

.....

2. ....

..... [2]

(b) Fig. 2.2 shows an insect.

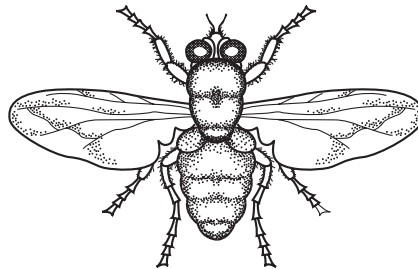

Fig. 2.2

Describe two external features that occur in insects but do **not** occur in other arthropods.

1. ....

.....

2. ....

..... [2]

[Total: 4]

3 Fig.3.1 shows a section through the eye.

For  
Examiner's  
Use

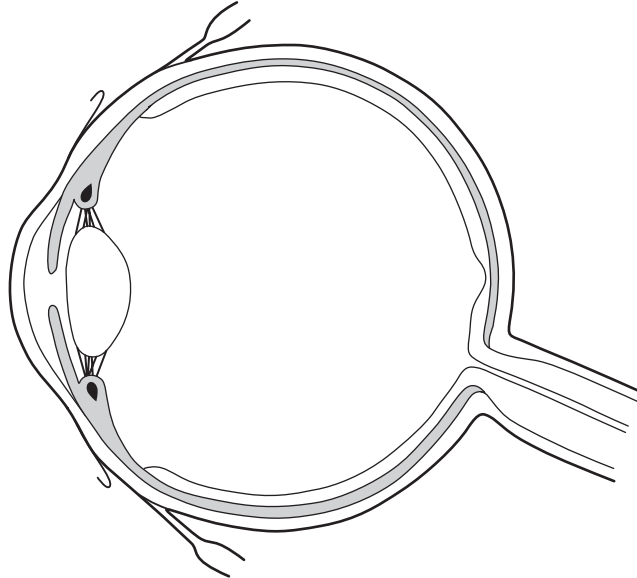

**Fig. 3.1**

**(a)** On Fig.3.1, label the ciliary muscle, the iris and the optic nerve.

Use label lines and the words 'ciliary muscle', 'iris' and 'optic nerve' on Fig. 3.1. [3]

**(b)** Describe the function of the retina in the eye.

.....  
.....  
..... [2]

**(c)** Explain how and why the size of the pupil changes when a person goes out of a dark room into very bright sunlight.

.....  
.....  
.....  
.....  
.....  
..... [4]

[Total: 9]

4 Suggest and explain how humans can cause three undesirable effects on ocean ecosystems.

1. ....  
.....  
.....  
.....

2. ....  
.....  
.....  
.....

3. ....  
.....  
.....  
.....

[6]

[Total: 6]

**Question 5 starts on the next page**

5 Fig. 5.1 shows the mean heights of female humans between birth and 25 years of age.

For  
Examiner's  
Use

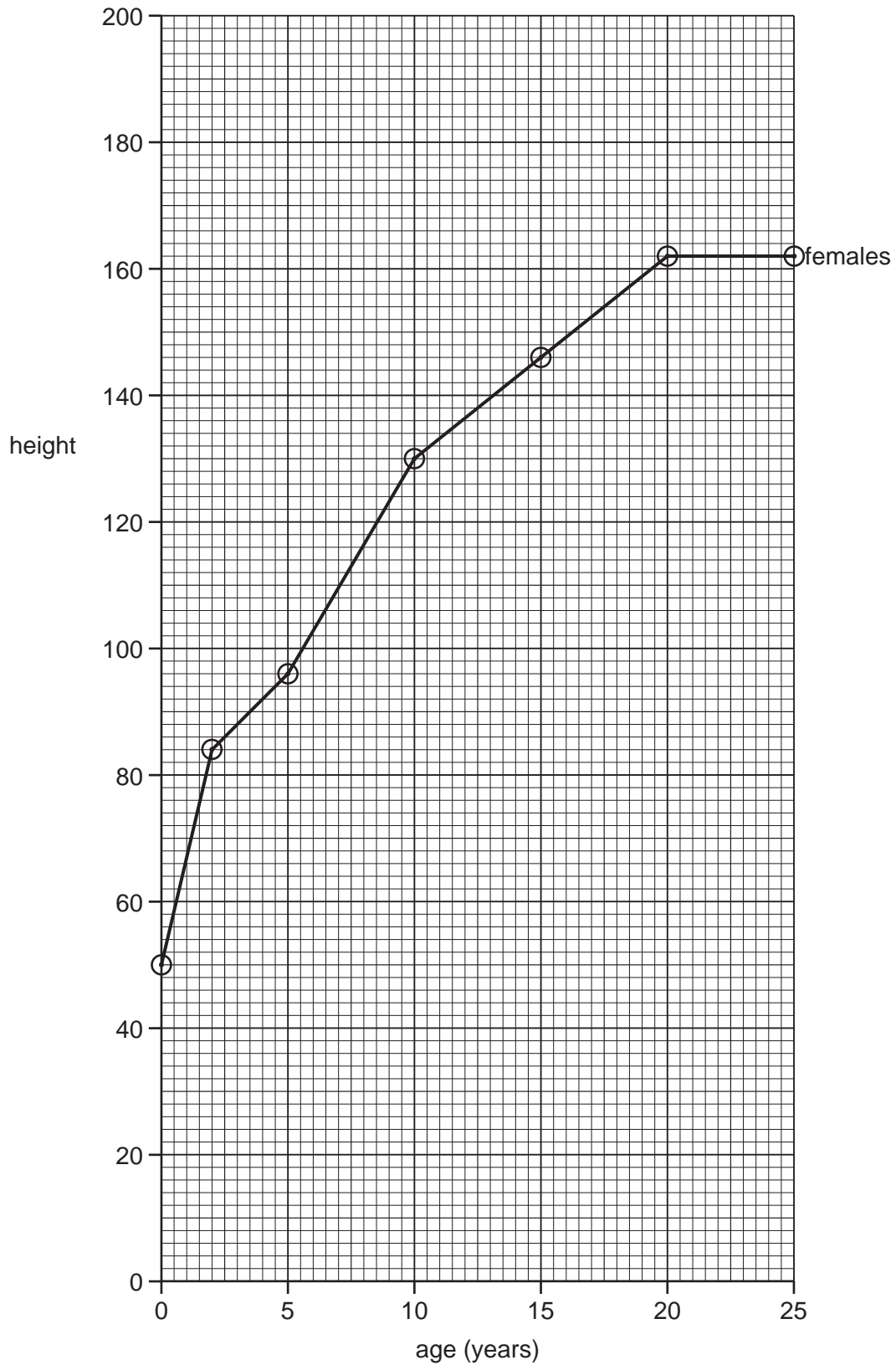

Fig. 5.1



Table 5.1 gives the mean heights of males over the same period of their lives.

For  
Examiner's  
Use

**Table 5.1**

age of males / years	mean height / cm
0	50
2	84
5	104
10	126
15	140
20	174
25	178

(a) (i) Plot the data for the males on Fig. 5.1.

Plot your points and draw your line on Fig. 5.1. [2]

(ii) Between which ages is the growth rate in males fastest?

..... [1]

(iii) At which **two** ages, after the age of 2 years, are males and females the same height?

..... [2]

(iv) At what age is the average height of females 144 cm?

..... [1]

(b) (i) Name the hormone that controls most of the changes that occur in females at puberty.

..... [1]

(ii) Describe some of the changes, apart from increases in height or mass, that occur in females during puberty.

.....  
.....  
.....  
.....  
..... [3]

[Total: 10]

6 Fig. 6.1 represents the carbon cycle.

For  
Examiner's  
Use

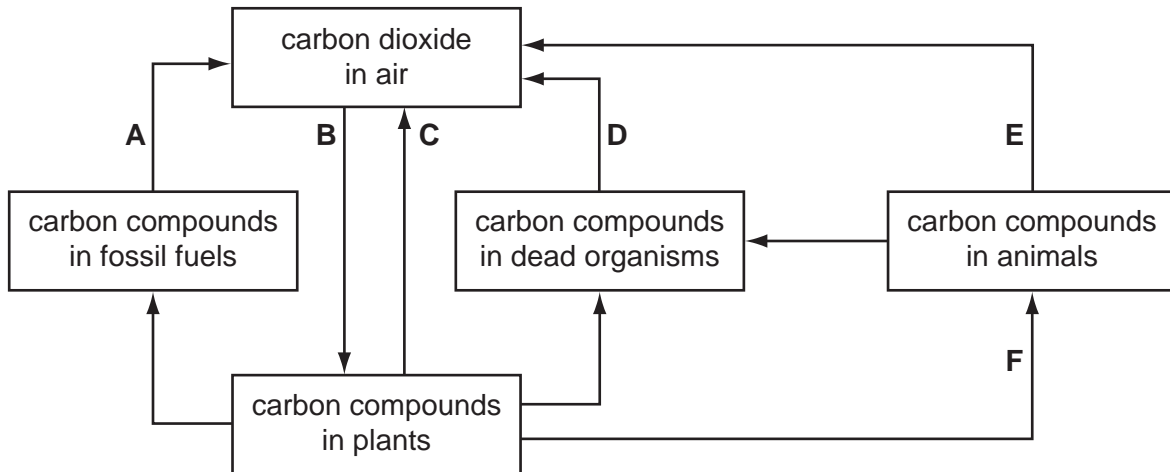

Fig. 6.1

(a) (i) Name the process labelled **A** on Fig. 6.1.

..... [1]

(ii) Name a group of organisms that are responsible for the process labelled **D** on Fig. 6.1.

..... [1]

(iii) Which **two** letters identify respiration on Fig. 6.1?

..... [2]

(iv) Which letter identifies photosynthesis on Fig. 6.1?

..... [1]

(b) In the box, state the word equation for photosynthesis.

[2]

(c) Suggest reasons why the mean percentage of carbon dioxide in the atmosphere has increased during the last 100 years.

*For  
Examiner's  
Use*

.....

.....

.....

.....

..... [3]

[Total: 10]

7 The volume of blood pumped out of the heart per minute is known as the cardiac output.

The cardiac output depends on the heart rate and the volume of blood pumped during each heartbeat, which is known as the stroke volume.

$$\text{cardiac output} = \text{heart rate} \times \text{stroke volume}$$

Table 7.1 gives data for a person at rest and after exercise.

**Table 7.1**

	heart rate / beats per minute	stroke volume / dm <sup>3</sup>	cardiac output / dm <sup>3</sup> per minute
person at rest	75	0.07	.....
person after exercise	191	0.11	21.01

(a) (i) Calculate the cardiac output for the person at rest and record the result in Table 7.1.

Write your answer in the space in Table 7.1. [1]

(ii) Calculate by how many times the cardiac output increases when the person exercises to the level shown in Table 7.1. Show your working.

Answer ..... [2]

(iii) Suggest why the body needs a greater cardiac output during exercise.

.....

.....

.....

.....

.....

.....

..... [4]

(b) (i) Name the chamber of the heart that pumps blood to the lungs.

..... [1]

(ii) State which component of the blood carries oxygen.

..... [1]

(iii) Describe **three** features of the lungs that make gaseous exchange an efficient process.

.....  
.....  
.....  
.....  
..... [3]

[Total: 12]

8 Polydactyly is a condition in which people have more than ten fingers or ten toes.

Fig. 8.1 shows the inheritance of polydactyly in three generations of a family.

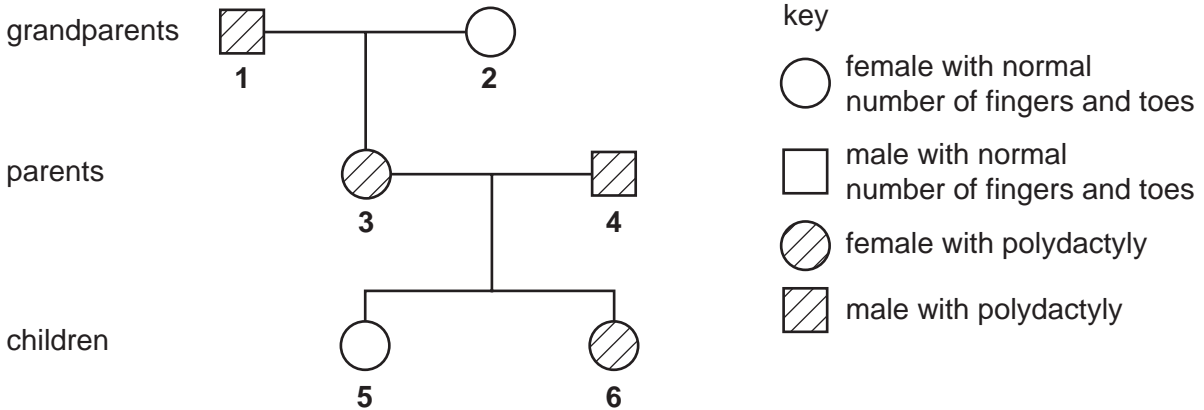

Fig. 8.1

Polydactyly is controlled by a single gene that has both dominant and recessive alleles.

(a) Explain what is meant by each of the terms

(i) *allele*

.....  
 ..... [1]

(ii) *recessive*.

.....  
 ..... [1]

(b) The allele causing polydactyly is dominant.

Which evidence, from Fig. 8.1, shows that the allele causing polydactyly is dominant?  
 Explain your answer.

.....  
 .....  
 ..... [2]

(c) Using the symbols **F** and **f** for the dominant and recessive alleles,

(i) state the genotype of grandparent **2**

..... [1]

(ii) state the possible genotypes of child **6**.

..... [2]

(d) State which **two** members of the family must be heterozygous for polydactyly.

..... [2]

(e) Scientists have stated that polydactyly first appeared because of a mutation.

Define the term *mutation*.

.....  
..... [1]

[Total: 10]

9 Fig. 9.1 is a transverse section of part of a young dicotyledonous plant.

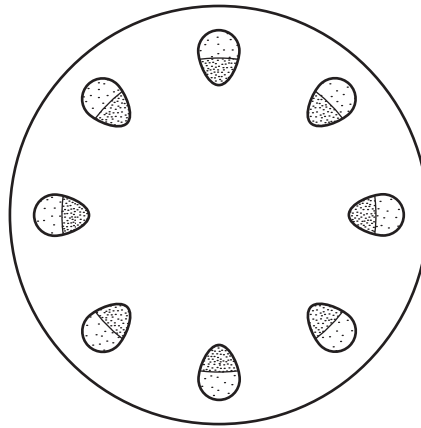

Fig. 9.1

(a) State the part of the plant from which this section has been cut.

..... [1]

(b) On Fig. 9.1, label the phloem tissue and the xylem tissue.  
Use label lines and the words 'xylem' and 'phloem' on Fig. 9.1.

[2]

(c) Describe the functions of the phloem and xylem.

phloem .....

.....

..... [2]

xylem .....

.....

..... [2]

[Total: 7]

Permission to reproduce items where third-party owned material protected by copyright is included has been sought and cleared where possible. Every reasonable effort has been made by the publisher (UCLES) to trace copyright holders, but if any items requiring clearance have unwittingly been included, the publisher will be pleased to make amends at the earliest possible opportunity.

University of Cambridge International Examinations is part of the Cambridge Assessment Group. Cambridge Assessment is the brand name of University of Cambridge Local Examinations Syndicate (UCLES), which is itself a department of the University of Cambridge.