



UNIVERSITY OF CAMBRIDGE INTERNATIONAL EXAMINATIONS  
International General Certificate of Secondary Education

**AGRICULTURE**

**0600/01**

Paper 1 Multiple Choice

**October/November 2010**

**45 minutes**

Additional Materials: Multiple Choice Answer Sheet  
Soft clean eraser  
Soft pencil (type B or HB is recommended)



**READ THESE INSTRUCTIONS FIRST**

Write in soft pencil.

Do not use staples, paper clips, highlighters, glue or correction fluid.

Write your name, Centre number and candidate number on the Answer Sheet in the spaces provided unless this has been done for you.

There are **forty** questions on this paper. Answer **all** questions. For each question there are four possible answers **A, B, C** and **D**.

Choose the **one** you consider correct and record your choice in **soft pencil** on the separate Answer Sheet.

**Read the instructions on the Answer Sheet very carefully.**

Each correct answer will score one mark. A mark will not be deducted for a wrong answer.

Any rough working should be done in this booklet.

This document consists of **15** printed pages and **1** blank page.



1 What is **not** provided for the family by livestock farming?

- A clothing
- B drink
- C electricity
- D food

2 In which is the use of chemical pesticides prohibited?

- A crop rotation
- B mixed farming
- C monoculture
- D organic farming

3 A soil has been shaken with water and allowed to settle.

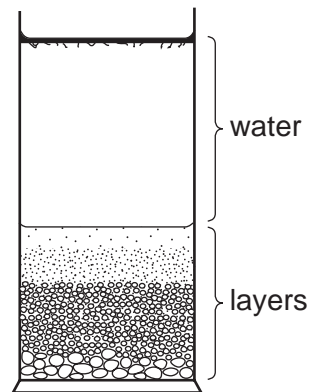

What are the characteristics of this soil?

	warms up slowly	easily leached	easy to work
<b>A</b>	✓	✓	x
<b>B</b>	✓	x	x
<b>C</b>	x	✓	✓
<b>D</b>	x	x	✓

- 4 The pie chart shows the proportions of different parts of a soil sample.

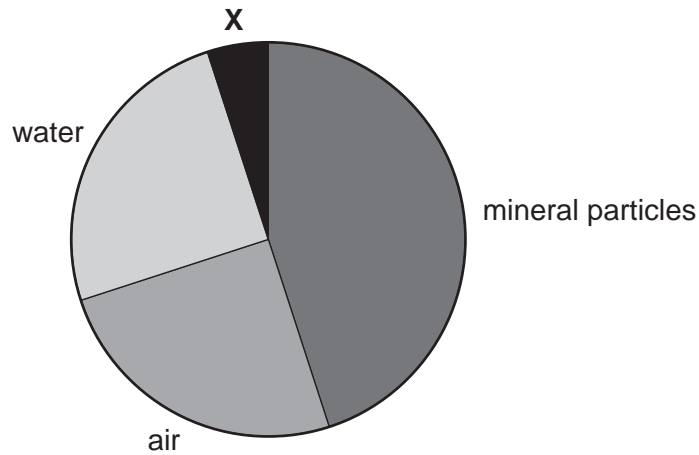

What is **X**?

- A carbon dioxide
  - B nitrates
  - C organic matter
  - D sand
- 5 What causes chemical weathering of rocks?
- A acid rain
  - B fast-flowing rivers
  - C freezing water in crevices
  - D wind-blown sand
- 6 How will a waterlogged soil affect plants?
- A It will decrease root respiration.
  - B It will decrease the risk of fire damage.
  - C It will form erosion channels.
  - D It will speed up mineral intake.
- 7 Which crop plant has a stem modified for food storage?
- A bean
  - B Irish potato
  - C maize
  - D sweet potato

8 The diagram shows a maize plant.

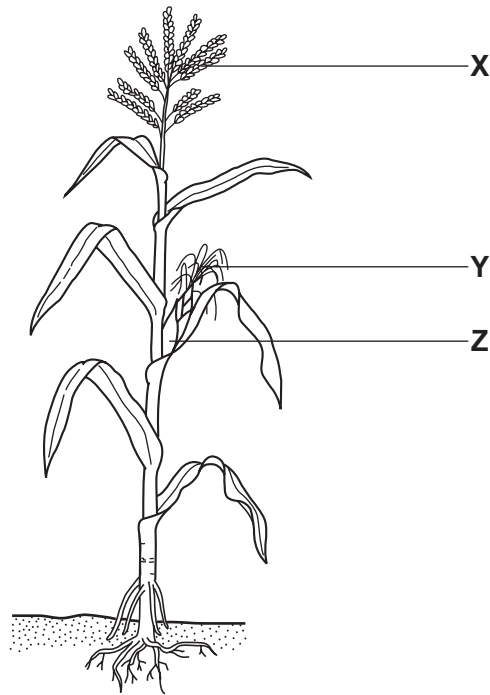

What are the correct labels for X, Y and Z?

	X	Y	Z
A	silk	cob	tassel
B	silk	tassel	cob
C	tassel	cob	silk
D	tassel	silk	cob

9 During which process is energy released from food?

- A osmosis
- B photosynthesis
- C respiration
- D transpiration

10 Which is part of a bean flower?

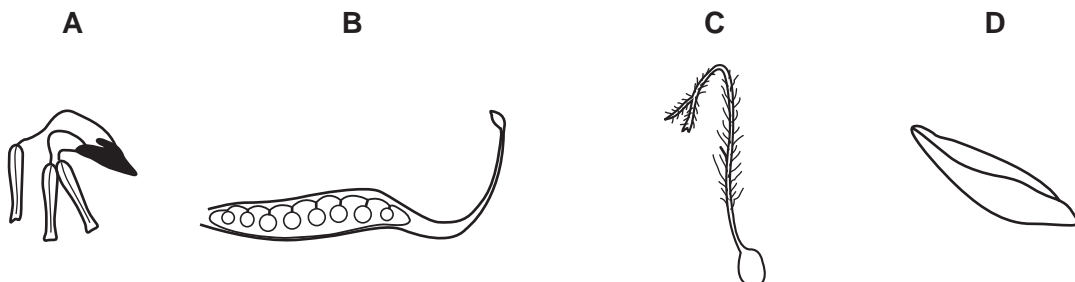

11 The diagram shows the cross section of a plant stem.

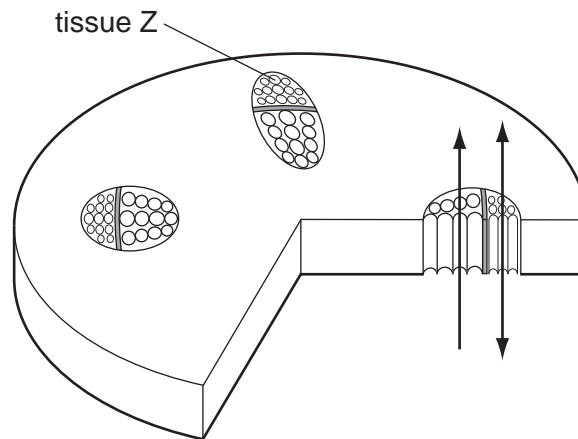

Arrows indicate direction of movement of substances.

What is carried by tissue Z (phloem)?

- A chlorophyll
- B mineral salts
- C starch
- D sugar

12 The diagram shows a bag of compound fertiliser.

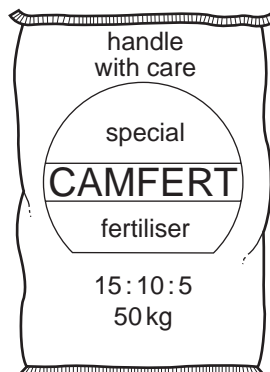

What is the potash content of the fertiliser?

- A 5%
- B 10%
- C 15%
- D 50%

13 When should bulky organic manure be applied for a cereal crop?

- A after planting
- B before ploughing
- C between harrowing and planting
- D between ploughing and harrowing

**14** A cereal crop must be dry before it is stored.

Why should it be dry?

- A** It is less likely to be eaten by insects.
- B** It is less likely to rot.
- C** It is lighter to carry.
- D** It takes up less space.

**15** A cereal crop has been sprayed with a chemical insecticide.

Why should it be left for two weeks before harvesting?

- A** Spraying slows the ripening of the grain.
- B** The insecticide is harmful if eaten by mammals.
- C** Time is needed for the dead insects to drop off.
- D** Time is needed for the insecticide to take effect.

**16** A cereal crop is to be sprayed with a herbicide.

What reduces the risk of damage to a crop of beans in the next plot?

- A** applying a coarse spray
- B** applying a fine spray
- C** positioning spray jets well above the cereal crop
- D** taking care to use the correct dilution rate

**17** A herbicide is sprayed to kill weeds. It is absorbed by the leaves and moves through the stem to all parts of the plant.

What is this type of herbicide called?

- A** contact
- B** residual
- C** selective
- D** systemic

18 The diagram shows the reproductive system of a female farm animal.

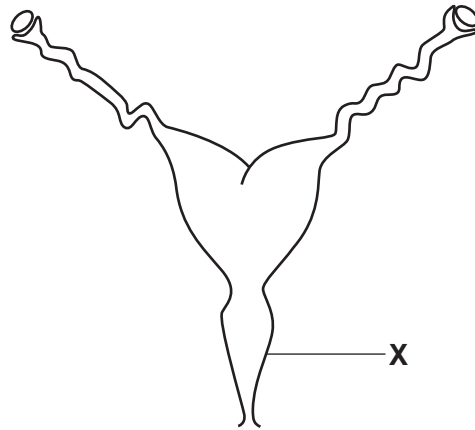

What is structure **X**?

- A cervix
- B uterus
- C vagina
- D vulva

19 The table lists some parts of a non-ruminant digestive system and their main functions.

part of the digestive system	function
caecum	contains microorganisms to digest cellulose
large intestine	absorbs water
small intestine	absorbs digested food
stomach	mechanically churns food

In which order are these parts in the digestive system?

- A caecum → small intestine → large intestine → stomach
- B caecum → stomach → small intestine → large intestine
- C stomach → large intestine → caecum → small intestine
- D stomach → small intestine → caecum → large intestine

20 In which part of the digestive system of a non-ruminant does digestion take place in strongly acid conditions?

- A duodenum
- B ileum
- C mouth
- D stomach

21 What describes the length of the oestrus cycle?

- A the duration of pregnancy
- B the duration of the heat period
- C the interval between birth and mating
- D the interval between the start of heat periods

22 Why must sick animals be isolated?

- A to prevent making extra work
- B to prevent their disease spreading
- C to prevent them feeding freely
- D to prevent them from getting dirty

23 Rats can be vectors (carriers) of disease-causing organisms.

Which feature of animal houses will help to prevent the spread of disease by rats?

- A a constant water supply
- B a corrugated iron roof
- C a covered food store
- D good ventilation

24 In parts of Africa, farmers make 'licks' for cattle using a local clay-like soil.

What are these 'licks' likely to add to the diet of the cattle?

- A cellulose
- B protein
- C sodium
- D vitamins

25 Grass is the main food for many ruminants.

What does grass **not** supply to the animal?

- A fats
- B fibre
- C minerals
- D water



26 For what does an animal use the protein in its diet?

- A energy
- B healthy teeth
- C insulation
- D tissue repair

27 A pure-bred polled (no horns) bull is mated with a herd of pure-bred horned cows.

All the calves produced are polled.

What describes the allele that controls the horned condition?

- A dominant
- B recessive
- C heterozygous
- D homozygous

28 Milk yield, calf mortality and disease resistance are all genetically controlled.

The table compares the milk yield, calf mortality and disease resistance of four cows, W, X, Y and Z.

	level shown by each of the cows W, X, Y and Z, for each of the characteristics					
	high	→	average	→	low	
milk yield	W		Z		Y	X
calf mortality	Y		W		X	Z
disease resistance	Z		Y		W	X

Which cow should be selected for breeding to provide the best calves?

- A W
- B X
- C Y
- D Z

29 A pasture, divided into four paddocks, has a carrying capacity of one sheep per two hectares.

Which paddock is overstocked?

	number of sheep	area of paddock (hectares)
<b>A</b>	65	125
<b>B</b>	75	150
<b>C</b>	85	175
<b>D</b>	95	200

30 Legumes are valuable pasture plants but some do not grow well in sandy, acid soils.

Which process of pasture improvement would encourage the growth of these legumes?

- A** draining the pasture
- B** irrigating the pasture
- C** spreading lime
- D** spreading nitrogen fertiliser

31 A farmer made a straight fence using wire and posts.

After some weeks, the end posts began to lean inwards.

How can he stop the end posts leaning inwards?

- A** support the insides of the end posts
- B** support the outsides of the end posts
- C** use stronger posts
- D** use stronger wire

32 The diagram shows a wire mesh fence.

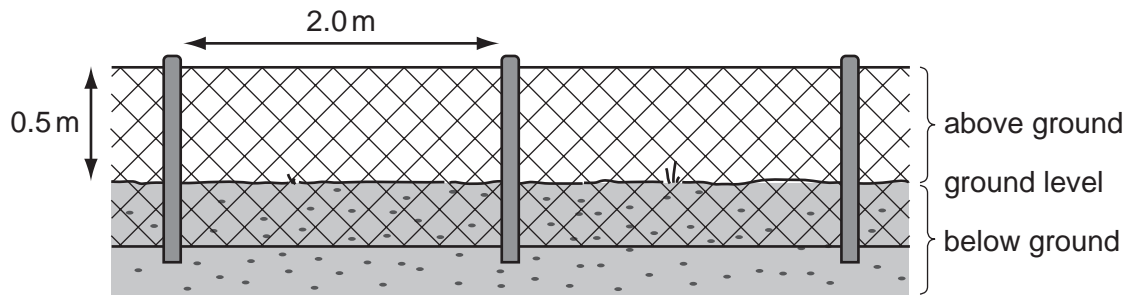

Which type of animal could be successfully enclosed by this fence?

- A cattle
- B chickens
- C goats
- D rabbits

33 What must be added to cement to make concrete for a concrete floor?

	sand	soil	stones	water
<b>A</b>	✓	✓	✓	
<b>B</b>	✓	✓		✓
<b>C</b>	✓		✓	✓
<b>D</b>		✓	✓	✓

34 The diagram shows the wood moulds for making two types of cement block.

Mould P is used for making solid blocks. Mould R is used for making blocks with holes through the middle.

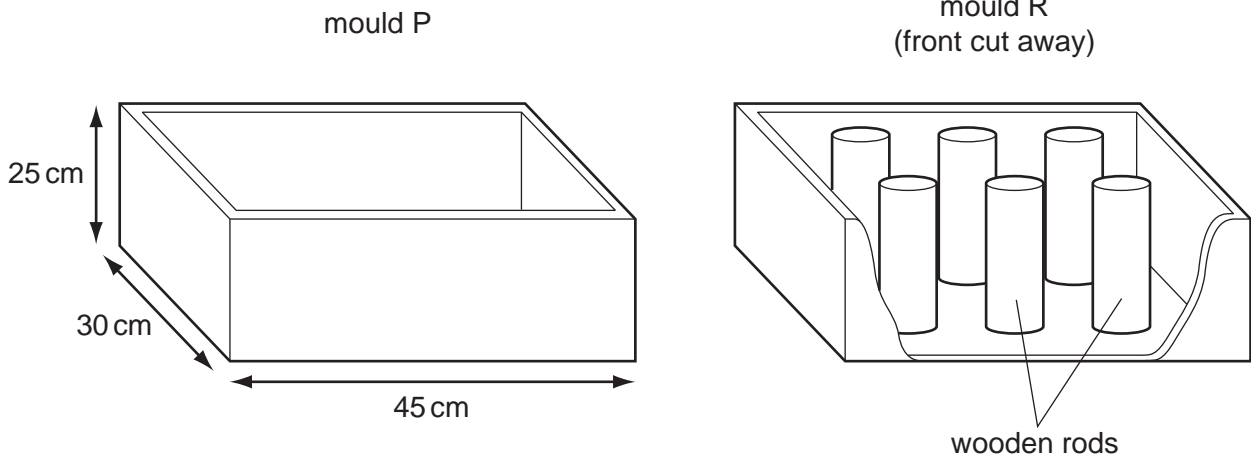

What is the advantage of blocks made using mould R rather than mould P?

- A They are less likely to crack.
- B They are lighter to handle.
- C They are more long lasting.
- D They withstand greater pressure.

35 Rainwater collected from the roof of a farm building is to be used to irrigate a vegetable plot.

What needs to be done before it is used?

- A nothing
- B removal of sediment by settling
- C settling and sand filtration
- D settling, sand filtration and adding chlorine

36 A farm house and grazing cattle obtain their water from a river.

Which arrangement of land use provides clean water for both?

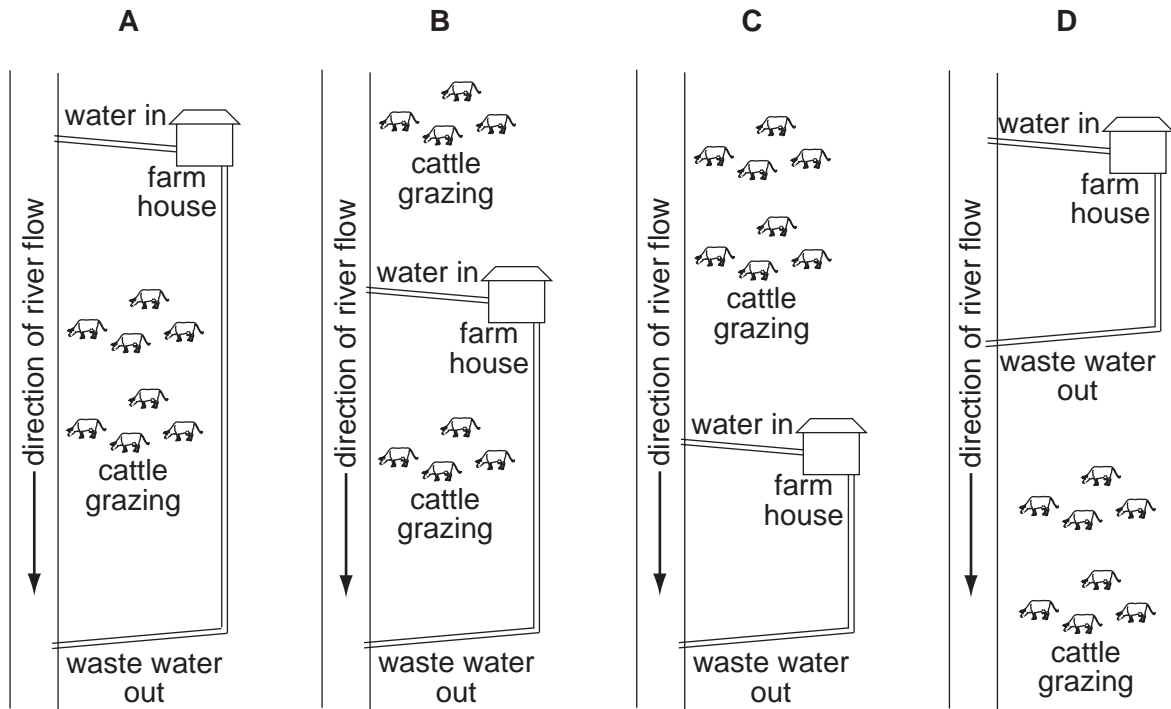

37 When using a rope to secure a load on a trailer, a farmer needs to use two knots. One is to shorten the rope and the other is for quick release.

Which pair of knots should he use?

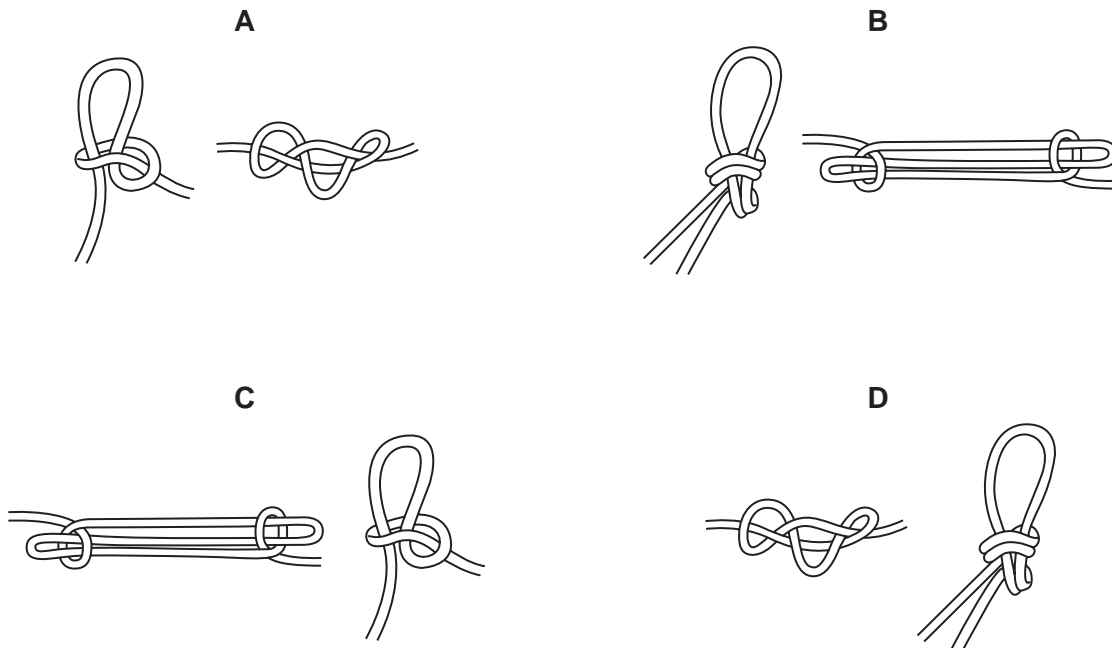

38 The teeth of a saw used to cut wood are set at an angle to the blade.

Why are the teeth set at an angle and not in line with the blade?

- A so that the saw can bite into the wood as it cuts
- B so that the saw can make a groove in the wood to pass through
- C so that the saw does not make too much noise
- D so that the teeth push the sawdust out of the cut

39 The diagram shows the valves in a pump used to raise water from a well.

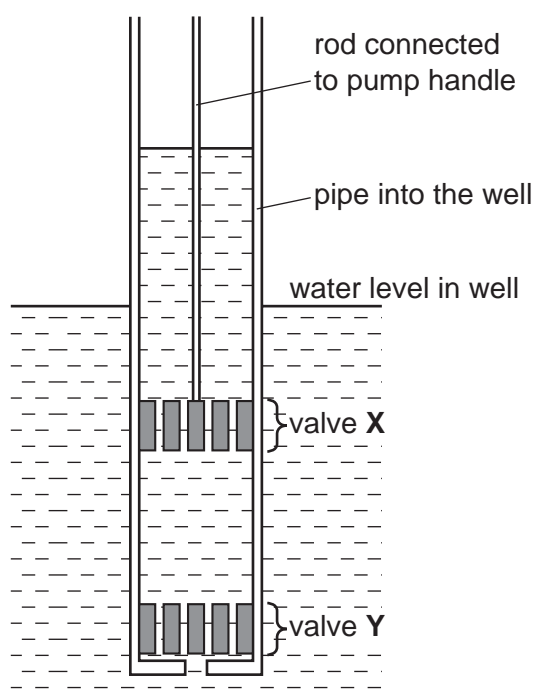

Which valves move or remain stationary as the water is pumped?

	valve X	valve Y
A	moves up and down	moves up and down
B	moves up and down	remains stationary
C	remains stationary	moves up and down
D	remains stationary	remains stationary

- 40 Which conditions of supply and demand for a farm product are likely to result in the highest price at the market?

	supply	demand
<b>A</b>	plentiful	high
<b>B</b>	plentiful	low
<b>C</b>	short	high
<b>D</b>	short	low

**BLANK PAGE**

---

Permission to reproduce items where third-party owned material protected by copyright is included has been sought and cleared where possible. Every reasonable effort has been made by the publisher (UCLES) to trace copyright holders, but if any items requiring clearance have unwittingly been included, the publisher will be pleased to make amends at the earliest possible opportunity.

University of Cambridge International Examinations is part of the Cambridge Assessment Group. Cambridge Assessment is the brand name of University of Cambridge Local Examinations Syndicate (UCLES), which is itself a department of the University of Cambridge.