



UNIVERSITY OF CAMBRIDGE INTERNATIONAL EXAMINATIONS
General Certificate of Education
Advanced Subsidiary Level and Advanced Level

THINKING SKILLS

9694/13

Paper 1 Problem Solving

May/June 2012

1 hour 30 minutes

Additional Materials: Multiple Choice Answer Sheet
Soft clean eraser
Soft pencil (type B or HB is recommended)



READ THESE INSTRUCTIONS FIRST

Write your Centre number, candidate number and name on all the work you hand in.

There are **30** questions on this paper. Answer **all** the questions.

For each question there are four possible answers **A, B, C** and **D**. Choose the **one** you consider correct and record your choice in pencil on the separate answer sheet.

Read very carefully the instructions on the answer sheet. Ignore responses numbered 31 – 40 on the answer sheet.

INFORMATION FOR CANDIDATES

Each correct answer will score one mark. A mark will not be deducted for a wrong answer.

This document consists of **19** printed pages and **1** blank page.



- 1 Tom has felt for a period of time that he is overweight, and that he would like to have a healthy weight. He is 160 cm tall and 75 kg in weight. A Body Mass Index (BMI) is a measure of someone's weight in relation to height; $BMI = \text{weight}/\text{height}^2$.

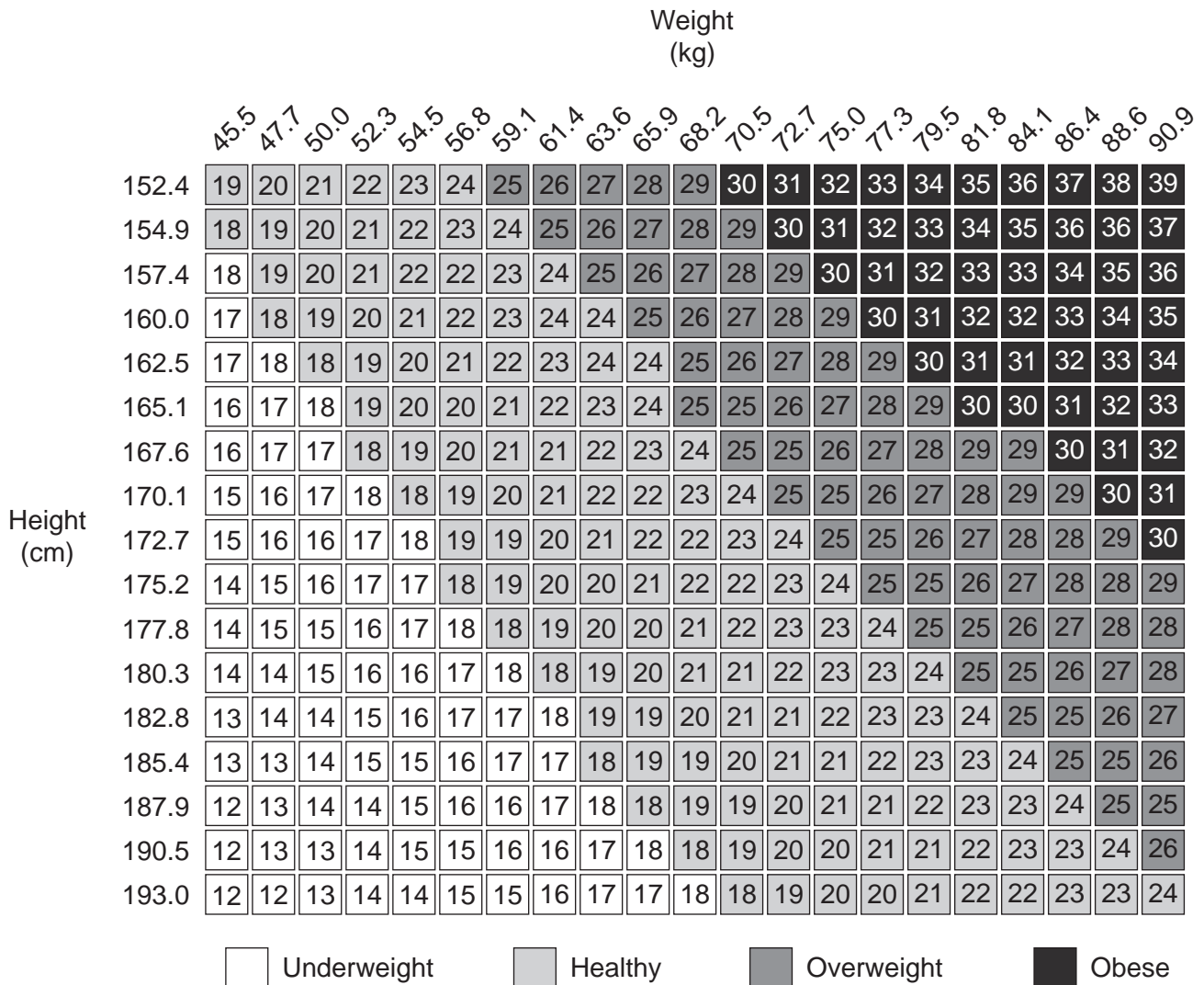

What is the minimum weight Tom would have to lose in order to be a healthy weight?

- A 4.0 kg
 B 5.0 kg
 C 9.1 kg
 D 11.4 kg

- 2 I need to use the bus service to get to work. There are two different routes that I could use to get to the central bus station and then I need to catch another bus from there to get to work.

To get to the central bus station I could catch a bus from the end of my street (which I can get to in 2 minutes). This bus service runs every 15 minutes starting at 06:00 and takes 34 minutes to get from my street to the central bus station. The alternative is to walk for 10 minutes to a different stop. The buses from there run every 30 minutes starting at 06:15 and take 23 minutes to get to the central bus station. I need to allow 2 minutes to change buses at the central bus station. The bus that I need to take from the central bus station to work takes 21 minutes and leaves every 15 minutes, starting from 07:05. I then need 5 minutes to walk to work from the bus stop and I have to be at work by 08:30.

What is the latest possible time that I could leave home?

- A 06:58
 - B 07:05
 - C 07:13
 - D 07:15
- 3 Billy runs a corner shop. He is having a New Year sale and decides to reduce the price of cornflakes by dropping the profit he makes on each packet (i.e. his selling price minus his buying price) by 25%. He finds that, during the week of his sale, he has made 20% more profit overall on cornflakes than he usually does.

By what percentage did the number of packets of cornflakes sold increase during the sales week compared with a normal week?

- A 20%
- B 45%
- C 60%
- D 80%

- 4 Financial services usually have a disclaimer that “past performance is no indicator of future returns”, yet they also advertise using past performance.

Which one of the following graphs is not consistent with the claim that “in most years the value of our unit bond has increased by over \$10”?

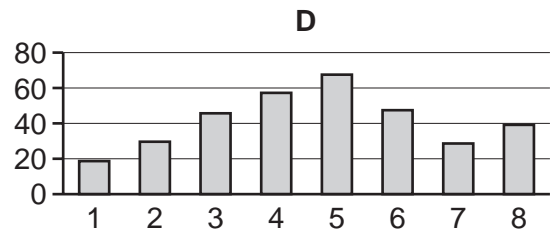
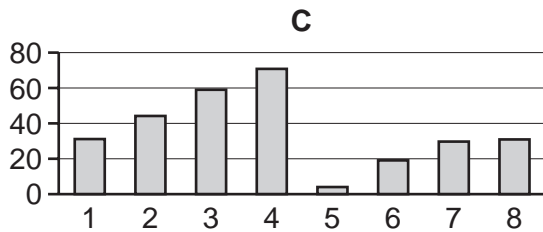
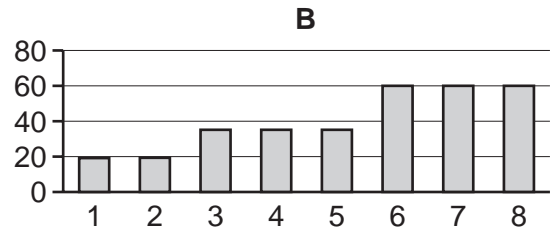
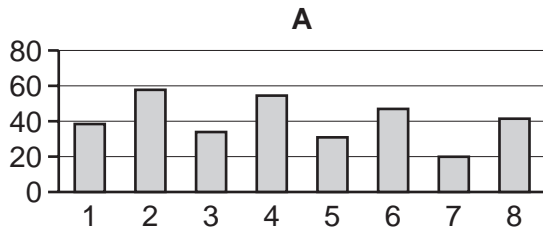

- 5 My local gym is holding a competition. Each week the four competitors must compete on a different piece of equipment. This week is the final round of the men’s competition and they must row 2 km as quickly as they can. To ensure that the competition is fair all competitors use the same rowing machine. The quickest will get 4 points, second place will get 2 points and third place will get 1 point. The competitor with the highest total score will win the overall competition, and if there is a tie the prize will go to whichever of them came first in the most events. The scores from the previous three rounds are shown below.

<i>Competitor</i>	<i>Treadmill</i>	<i>Cross trainer</i>	<i>Bike</i>
Felix	4	1	1
Joe	0	0	4
Tim	2	4	2
Vincent	1	2	0

After the first three competitors had completed the rowing round, the fourth competitor declared that there was no point in his rowing as the overall winner was already determined.

Which of the following orders for the first three competitors (from quickest to slowest) would have been sufficient for this to be the case?

- A** Felix, Tim, Joe
B Felix, Tim, Vincent
C Joe, Vincent, Tim
D Vincent, Joe, Felix

6 The graph below shows the cumulative distribution of ages in the Bolandian population.

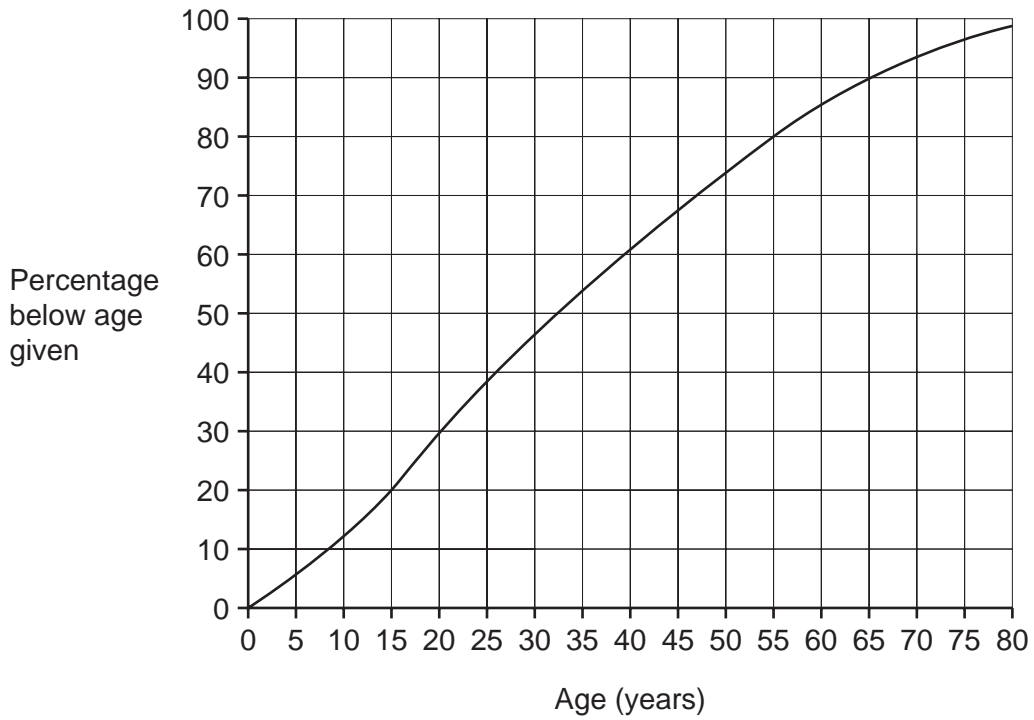

Ashley realises that exactly 20% of the population are older than him. How old is he?

- A 15 years
- B 30 years
- C 55 years
- D 98 years

- 7 A survey is to be carried out to identify the relationship between spending on food and personal weight (both expressed as a percentage above or below average).

The four diagrams below, all to the same scale, show some possible patterns that the results might take. The shaded areas show the ranges in which the results might occur.

Which one of the diagrams shows that those who spend more on their food tend to weigh less?

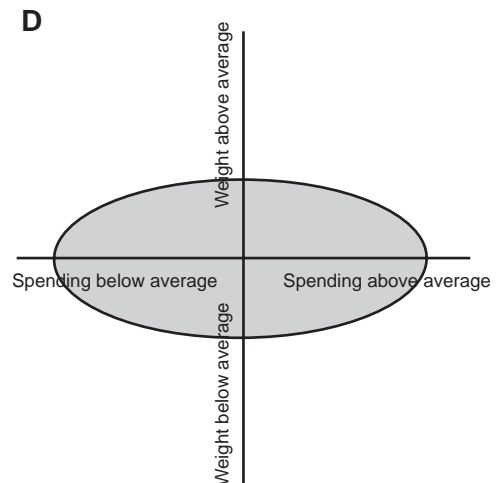
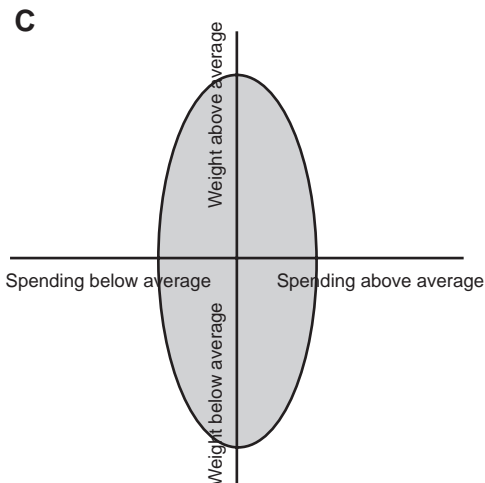
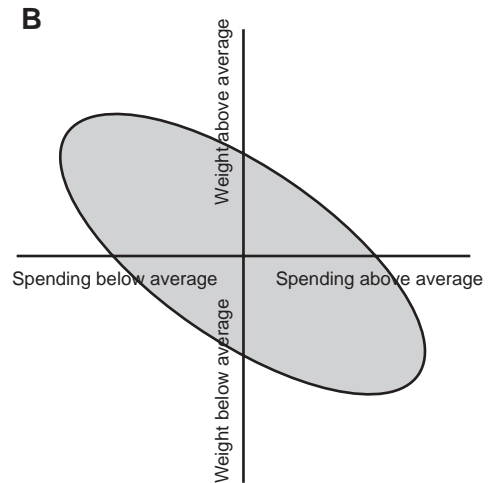
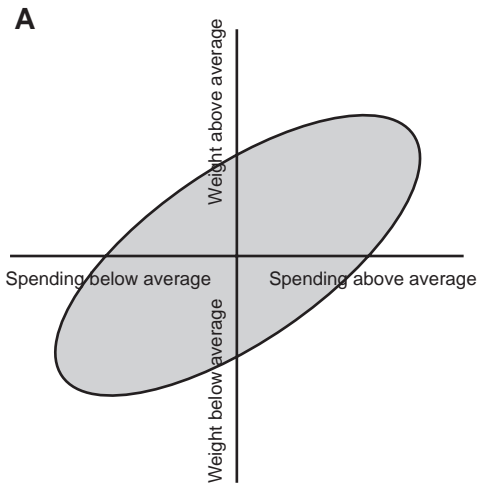

- 8 I am the manager of a mobile phone shop which is open 7 days a week. Our best-selling brand is the Ring-It phone. I never sell more than 10 Ring-Its and never fewer than 6 on any particular day. In addition, my assistant always sells at least 5 Ring-Its, but never as many as 10 per day.

I order the Ring-It phones from a depot every Sunday evening, and they arrive the following morning. They come in boxes of 10 or 12, but I can never be sure which I will get. I can only order a specific number of boxes, not individual phones. At closing time this Sunday I have only 8 Ring-It phones in stock.

How many boxes do I need to order to ensure that I do not run out of stock during the next week?

- A 11
 - B 12
 - C 13
 - D 14
- 9 Amy is on holiday in Larning and intends to visit Middleham, Nestwich, Oxton and Pentholme, returning to Larning.

There are bus routes between Larning and each of Middleham, Nestwich and Oxton. Buses also run between Oxton and each of Middleham, Nestwich and Pentholme. All of the buses just do a shuttle service between two towns.

What is the minimum number of single bus trips Amy must take to visit all four towns and return to Larning?

- A 5
- B 6
- C 7
- D 8

- 10 A high volume photocopying machine is to be used for a long print run of 90 000. The photocopier is able to print 50 copies per minute, and has a capacity of 9000 sheets of A4 paper. The paper tray is empty at the beginning of the print run. One ink cartridge is able to print 30 000 sheets, but the current one is only $\frac{2}{3}$ full at the start of the print run.

The time taken for the print run to finish depends upon the number of ink and paper reloads necessary, and also whether there are delays due to the machine breaking down or a monthly maintenance check. The time taken for each of these is listed below.

Breakdown	5 hours
Ink cartridge change	6 minutes
Monthly maintenance check	1 hour
Paper reload	6 minutes

After 26 hours, the print run is only 80% complete.

Which one of the following sets of events would be consistent with these figures?

- A** 7 paper reloads, 2 ink cartridge changes, 1 monthly maintenance check
B 7 paper reloads, 3 ink cartridge changes, 1 breakdown
C 8 paper reloads, 2 ink cartridge changes, 1 monthly maintenance check
D 8 paper reloads, 3 ink cartridge changes, 1 breakdown
- 11 A view of a carved block is shown below.

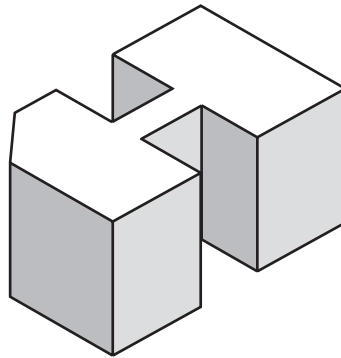

Which of the following plan views is **not** a possible representation of the carved block as seen from above?

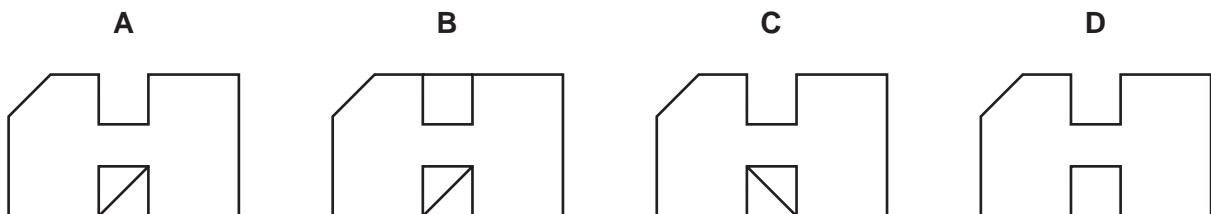

- 12 A group of 5 men are able to load a pile of 90 logs onto a truck in 15 minutes.

How long, to the nearest minute, would it take 3 men to load 120 logs, if they load them at the same rate?

- A 12 minutes
 B 19 minutes
 C 33 minutes
 D 40 minutes
- 13 Dave goes to the gym four days each week. He does a slightly different routine on each of his four visits. He never uses more than four pieces of equipment. His schedule for each visit (in minutes spent on each piece of equipment) is given in the table below, together with the hourly rate at which he burns off calories (kcal/hr).

	<i>Exercise bike</i> (400 kcal/hr)	<i>Cross-trainer</i> (600 kcal/hr)	<i>Treadmill</i> (750 kcal/hr)	<i>Rowing machine</i> (600 kcal/hr)
<i>Monday</i>	15 min	15 min	15 min	15 min
<i>Wednesday</i>	30 min	25 min	15 min	Not used
<i>Friday</i>	Not used	20 min	15 min	20 min
<i>Saturday</i>	60 min	Not used	15 min	Not used

On which visit does Dave burn off most calories?

- A Monday
 B Wednesday
 C Friday
 D Saturday

14 In an examination involving students from three schools, the following results were achieved:

	A	B	C	D	E	U
School 1	20	45	80	40	25	27
School 2	30	80	110	70	20	30
School 3	15	80	200	90	18	20
TOTAL	65	205	390	200	63	77

Which one of the following bar charts represents these results?

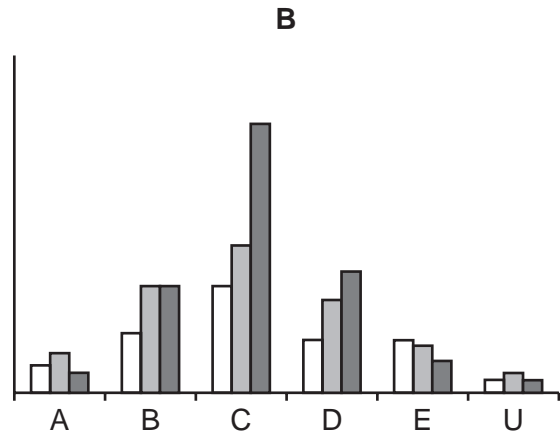
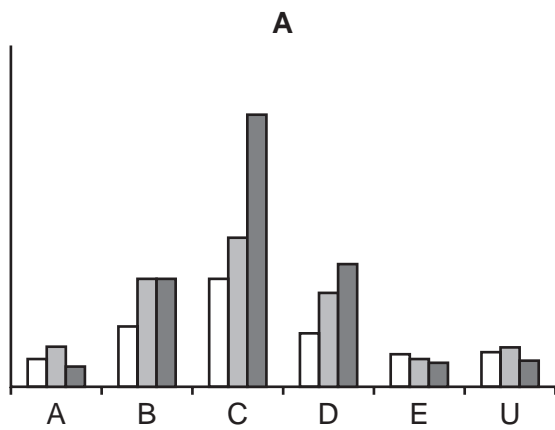

Key

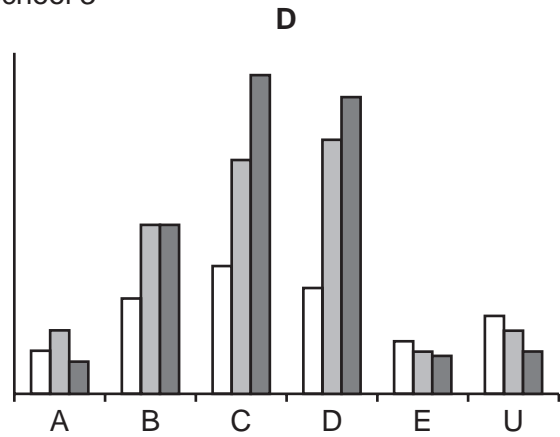
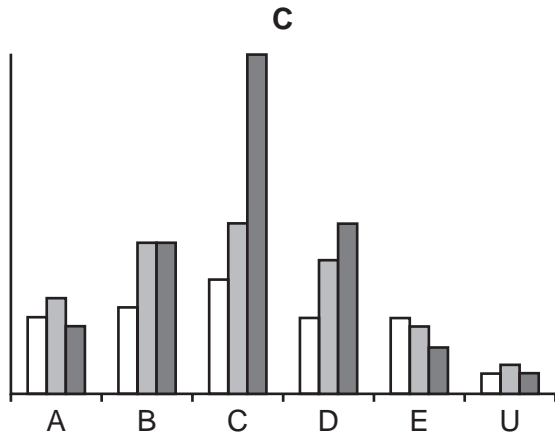
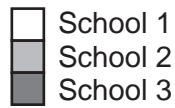

15 The honeycomb structure below is constructed by joining a number of hexagonal blocks together.

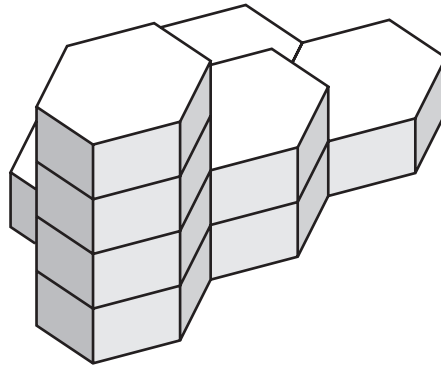

Which of the plan views below is a true representation of the 3-dimensional honeycomb structure, as seen from above?

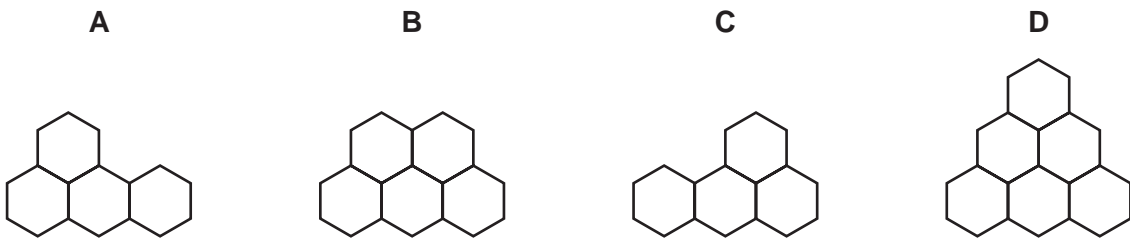

16 The diagram shows the shape of a container that is made from two cylindrical sections.

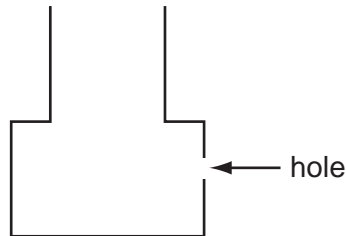

There is a hole in the bottom cylinder of the container. Water is poured into the container at a constant rate. Once the level of water has reached the hole, water starts to leak out at a constant rate that is half the rate at which water is being poured in.

Which graph best represents the rise in the level of water in the container?

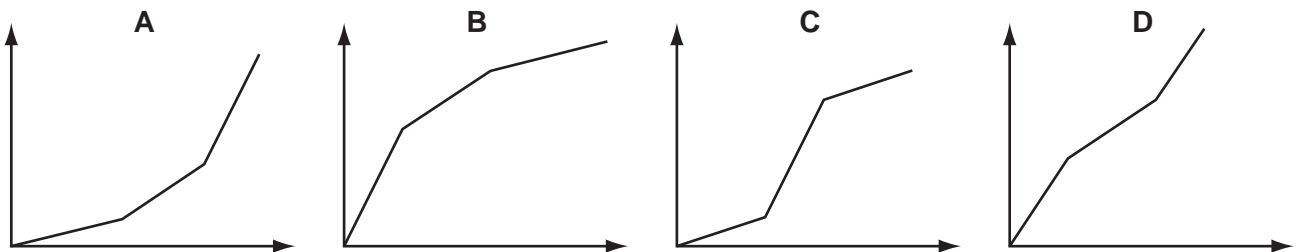

- 17 Yvonne needs to buy name tags for the book-writing convention this weekend. There are two suppliers that she can choose between. The first charges a fixed price of 3¢ per tag. The second supplier charges 4¢ per tag for the first 50 tags, 2¢ per tag for the next 100 tags and 1¢ per tag for any further tags. Whatever the quantity of tags she buys, Yvonne will choose the supplier from which the tags will cost the least.

Which graph correctly shows the total cost against the number of tags bought?

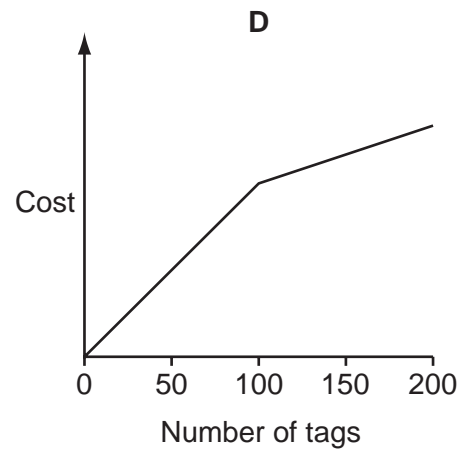
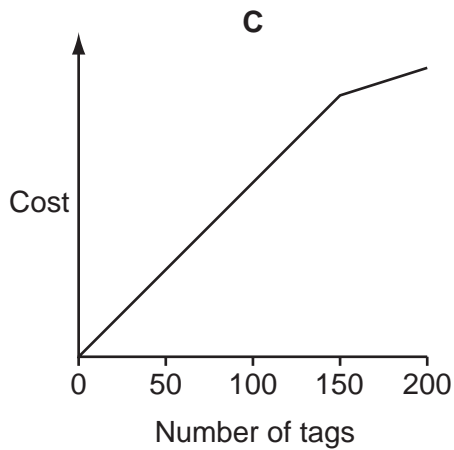
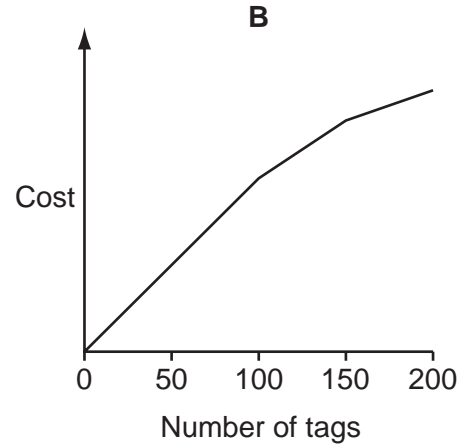
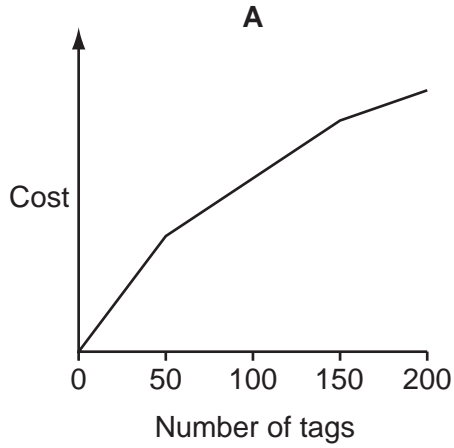

- 18 The organisers of a conference, with delegates from Germany, China, France and Italy, wish to choose which country's style of cooking should be used for the final grand banquet. The delegates were asked to rank the countries' cuisine in order of preference. Perhaps surprisingly, all delegates from any particular country had identical preferences. The table below shows these.

	<i>Country of origin</i>			
	<i>Germany</i>	<i>China</i>	<i>France</i>	<i>Italy</i>
<i>Number of delegates</i>	45	25	15	15
<i>First preference</i>	German	Chinese	French	Italian
<i>Second preference</i>	Chinese	French	Italian	French
<i>Third preference</i>	French	Italian	Chinese	Chinese
<i>Fourth preference</i>	Italian	German	German	German

Using these preferences the organisers decide to compare the cooking styles two at a time. Thus, for instance, they examine whether more delegates prefer German to Italian, or Italian to German; and they do this for every pair of styles. They decide that if one style is preferred to all others in these matches, then that style will be chosen for the banquet. Otherwise, the banquet's menu will be determined by a lottery.

What style of food will be served at the banquet?

- A Chinese
- B French
- C German
- D It will be determined by a lottery

19 The draw has been made for this year's Middle-earth Cup, as follows:

First Round

Match 1	Harrowdale	v	Rushey
Match 2	Nardol	v	Haysend
Match 3	Upbourn	v	Bucklebury
Match 4	Staddle	v	Esgaroth
Match 5	Bree	v	Hobbiton
Match 6	Tighfield	v	Bywater
Match 7	Crickhollow	v	Underharrow
Match 8	Rivendell	v	Little Delving

Second Round

Match 9	Overhill	v	Winner of Match 5
Match 10	Winner of Match 3	v	Isengard
Match 11	Stock	v	Winner of Match 1
Match 12	Winner of Match 6	v	Edoras
Match 13	Winner of Match 2	v	Frogmorton
Match 14	Tuckborough	v	Winner of Match 7
Match 15	Michel Delving	v	Winner of Match 4
Match 16	Winner of Match 8	v	Budgeford

Third Round

Match 17	Winner of Match 15	v	Winner of Match 12
Match 18	Winner of Match 11	v	Winner of Match 9
Match 19	Winner of Match 16	v	Winner of Match 13
Match 20	Winner of Match 10	v	Winner of Match 14

Semi-Finals

Match 21	Winner of Match 18	v	Winner of Match 20
Match 22	Winner of Match 19	v	Winner of Match 17

Final

Match 23	Winner of Match 22	v	Winner of Match 21
----------	--------------------	---	--------------------

All matches (including the Final) are to be played at the home ground of the first-named team.

Which team faces the prospect of having to play five matches, all away from home, in order to win this year's Middle-earth Cup?

- A Esgaroth
- B Hobbiton
- C Rushey
- D Underharrow

- 20 When Brenda opened the invoice that arrived with the delivery of the office supplies order, she was horrified when she saw that the total gross cost was \$380.

Upon checking carefully, however, she realised that on the order form she had put a tick by boxes of 12 pens instead of individual pens, but correctly entered the quantity required as 15.

She consoled herself that they would all get used eventually, and at least they were only \$18 per box whereas the individual pens would have cost \$2 each. Further consolation came when she read that customers ordering more than \$200 worth of goods should deduct 10% from the total gross cost.

When Brenda settles the invoice, how much more will she have spent than she intended?

- A \$202
 - B \$213
 - C \$216
 - D \$232
- 21 Rachel and Charles live in the same block of flats. At 10:00 Rachel set off to the post box. One minute later, Charles left to post some letters of his own. As Charles left, Rachel was half way to the post box. Charles passed Rachel when he was three fifths of the way to the post box and Rachel was on her way back. Both walked at constant speed and did not need to spend any time at the post box in order to post the letters.

What was the difference in their arrival times back at the flats?

- A 72 seconds
 - B 120 seconds
 - C 180 seconds
 - D 252 seconds
- 22 A question-master asks each of four contestants up to 15 questions. The process is repeated again for a second round. The 'score' is the number of questions answered correctly. The scores after each round are announced in ascending **numerical** order. After the first round of a contest the scores were 8, 10, 11, and 14.

After the second round the total scores for the contestants were 13, 18, 20, and 24.

What was the largest possible score achieved in the second round of this contest?

- A 10
- B 11
- C 14
- D 16

- 23 Hester requires 36 pieces of wood of length 1.5 m, 20 pieces of length 2.0 m and 20 pieces of 2.5 m. She can get pieces of wood of length either 4.0 m or 5.0 m which she can cut to the required sizes.

What is the smallest number of pieces of wood that Hester needs to buy to be able to cut all the pieces she requires?

- A 28
- B 29
- C 30
- D 32

- 24 The board game “Business” is played with two identical dice whose faces are numbered from 0 (a blank face) to 5, with opposite faces always adding up to 5.

The spots on the dice are dollar signs. This is how they appear at present, following the last player’s turn.

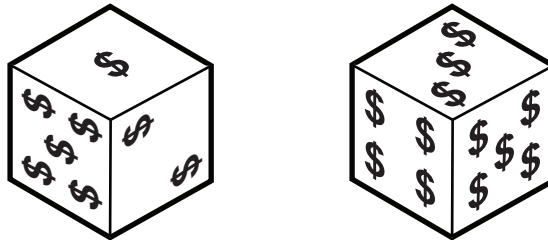

Which one of the following could be the appearance of one of the dice after the next player’s turn?

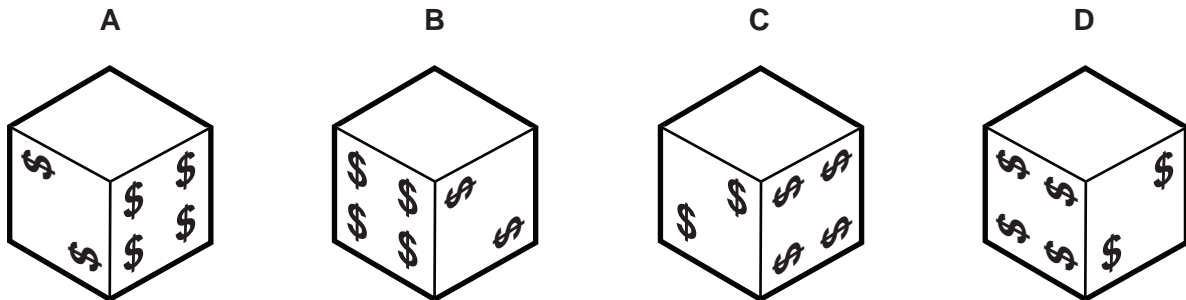

- 25** A non-stop train service runs between Anfang and Ende, a distance of 66 kilometres. The train normally travels at a steady 90 kilometres per hour, but increases its speed to 120 kilometres per hour if it is running behind schedule.

Yesterday, the first train of the day departed from Anfang on time, but, 18 kilometres into its journey, it was held up for 27 minutes by an obstruction on the line.

How late was the train at Ende?

- A** 16 minutes
 - B** 19 minutes
 - C** 24 minutes
 - D** 35 minutes
- 26** A man is 53 years old and receives \$32 000 a year as his salary; this is a fixed sum under his contract until he leaves his job. He would like to retire as soon as he is able to afford to do so. He has worked for 30 years and he knows that for every further year he completes up to 40 years he will receive another \$500 in annual pension. Once he has done 40 years his pension will have reached its maximum value which is half his salary.

In addition to his pension, when he retires he will receive a lump sum, which is currently \$100 000 and will increase by \$5000 per year until his retirement, when he will invest it at 5% interest.

He works out that he needs an income of \$24 000 a year on which to retire.

At what age will he be able to retire?

- A** 62 years
- B** 63 years
- C** 64 years
- D** 65 years

- 27 The price of posting a letter depends on the size of the letter and the class of post required. The different options are shown in the table.

<i>Size</i>	<i>Price (1st class)</i>	<i>Price (2nd class)</i>
Small	7¢	4¢
Large	22¢	17¢

At the moment there is one stamp for each amount of money needed, but it has been decided to introduce a new system where only two values of stamp are available. People wanting to post letters will then need to buy stamps to give the required total. It will be possible to make all four of the above prices exactly with a combination of the new stamps.

The values of the two stamps have been chosen so that their values add up to the largest total possible and their difference is as small as possible.

All parcels will cost six of the more expensive stamps and four of the cheaper ones.

How much will it cost to send a parcel?

- A 34¢
 - B 36¢
 - C 38¢
 - D 40¢
- 28 Last month there was a sponsored aerobics marathon at Hope Springs Leisure Centre. Each participant raised between \$200 and \$1000 for charity. The amount raised by Faith, written in the form \$XXX.XX, has three consecutive digits in descending order, followed by the sum of the three digits.

Which one of the following statements can be made with certainty about the digits that make up the amount that Faith raised?

- A All five digits are different.
- B The five digits alternate between odd and even digits.
- C The first digit is the highest of the five.
- D The sum of all five digits is a multiple of three.

- 29** A canal bridge is only wide enough for one boat. It takes 20 minutes for a boat to cross and boats have to leave at 5-minute intervals. There is a rule allowing the bridge to be used each way for one hour at a time (including crossing time), unless there is no boat waiting at the other end.

When our boat arrived at the bridge, just after 09:00, there was a queue of 12 boats in front of us and 10 boats at the other end, the first of which had just started to cross. No other boats arrived before we had crossed.

When did our boat arrive at the other side of the bridge?

- A** 10:55
 - B** 11:50
 - C** 11:55
 - D** 12:30
- 30** Ann, Beth, Chet, and Den took a test, but the teacher, in an attempt to get them to do some more thinking, did not give them their individual scores in the test but the following pieces of information.

The combined score of Ann and Beth was 127.

The combined score of Beth and Chet was 145.

The combined score of Chet and Den was 134.

Which one of the following additional pieces of information would be sufficient to enable the students to deduce their individual marks?

- A** The combined score of Ann and Den was 116.
- B** Beth scored 11 more than Den.
- C** The total score of all four students was 261.
- D** The combined score of Ann and Chet was 108.

BLANK PAGE

Permission to reproduce items where third-party owned material protected by copyright is included has been sought and cleared where possible. Every reasonable effort has been made by the publisher (UCLES) to trace copyright holders, but if any items requiring clearance have unwittingly been included, the publisher will be pleased to make amends at the earliest possible opportunity.

University of Cambridge International Examinations is part of the Cambridge Assessment Group. Cambridge Assessment is the brand name of University of Cambridge Local Examinations Syndicate (UCLES), which is itself a department of the University of Cambridge.