



UNIVERSITY OF CAMBRIDGE INTERNATIONAL EXAMINATIONS
General Certificate of Education
Advanced Subsidiary Level

PHYSICAL SCIENCE

8780/01

Paper 1 Multiple Choice

October/November 2013

40 minutes

Additional Materials: Multiple Choice Answer Sheet
Soft clean eraser
Soft pencil (type B or HB is recommended)
Data Booklet

READ THESE INSTRUCTIONS FIRST

Write in soft pencil.

Do not use staples, paper clips, highlighters, glue or correction fluid.

Write your name, Centre number and candidate number on the Answer Sheet in the spaces provided unless this has been done for you.

There are **thirty** questions on this paper. Answer **all** questions. For each question there are four possible answers **A, B, C** and **D**.

Choose the **one** you consider correct and record your choice in **soft pencil** on the separate Answer Sheet.

Read the instructions on the Answer Sheet very carefully.

Each correct answer will score one mark. A mark will not be deducted for a wrong answer.

Any working should be done in this booklet.

Electronic calculators may be used.

This document consists of **16** printed pages.



Relevant Data, Formulae and the Periodic Table are provided in the Data Booklet.

Section A

For each question there are four possible answers, **A**, **B**, **C**, and **D**. Choose the **one** you consider to be correct.

1 The pascal is the SI unit of pressure.

Which of the following expresses the pascal in base units?

- A** $\text{kg m}^{-1} \text{s}^{-1}$ **B** $\text{kg m}^{-1} \text{s}^{-2}$ **C** $\text{kg m}^3 \text{s}^{-2}$ **D** kg m s^2

2 A runner travels a distance of $50.4 \pm 0.5 \text{ m}$ in a time of $8.4 \pm 0.2 \text{ s}$.

What is his average speed during this time interval?

- A** $6.0 \pm 0.1 \text{ ms}^{-1}$
B $6.0 \pm 0.2 \text{ ms}^{-1}$
C $6.0 \pm 0.3 \text{ ms}^{-1}$
D $6.0 \pm 0.7 \text{ ms}^{-1}$

Space for working

- 3 A motor applies a constant force to a mass and lifts it at a constant velocity in the direction of the force. The frictional forces are negligible.

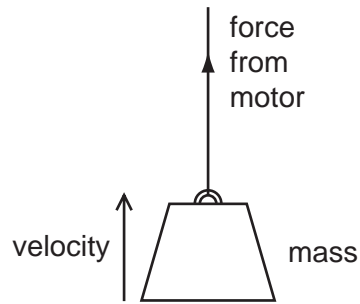

What does the product of the force and velocity measure?

- A the kinetic energy of the mass
 - B the potential energy gained by the mass
 - C the power output from the motor
 - D the work done by the motor
- 4 A ball of mass 0.500 kg is dropped from the edge of a cliff of height 50.0 m . It hits the ground at a speed of 15.0 m s^{-1} .

How much work is done by the ball against air resistance?

- A 56.3 J B 189 J C 245 J D 301 J

Space for working

- 5 A sound wave travels through the air. The graph shows the variation of pressure against distance along the wave at a particular instant.

Below the graph are four representations of the positions of the air particles along the wave at the same instant.

Which representation of the position of the particles in the wave is correct?

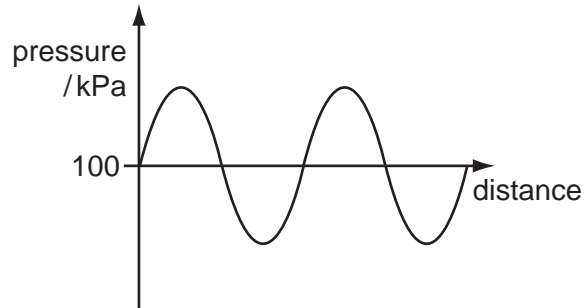

Space for working

6 The diagram represents an experiment to observe interference fringes.

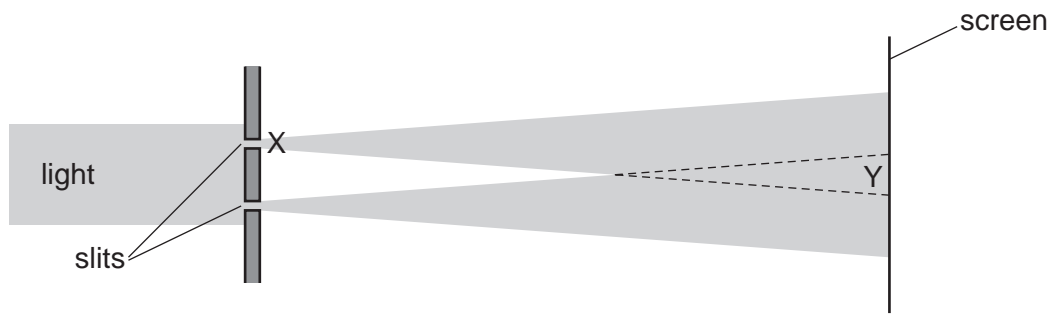

What happens at X and Y and what are the conditions necessary for interference fringes to be observed?

	what happens at X	necessary condition for this to happen at X	what happens at Y	necessary condition for this to happen at Y
A	diffraction	the light passing through the two slits must be coherent	interference	the slits must be narrow
B	diffraction	the slits must be narrow	interference	the light passing through the two slits must be coherent
C	interference	the light passing through the two slits must be coherent	diffraction	the slits must be narrow
D	interference	the slits must be narrow	diffraction	the light passing through the two slits must be coherent

Space for working

- 7 A small positive charge moves from X to Y between a pair of parallel charged metal plates.

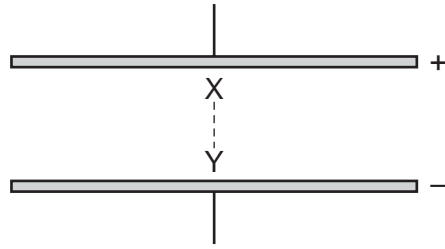

Which graph shows the variation in the force acting on the charge, due to the electric field, as it moves from X to Y?

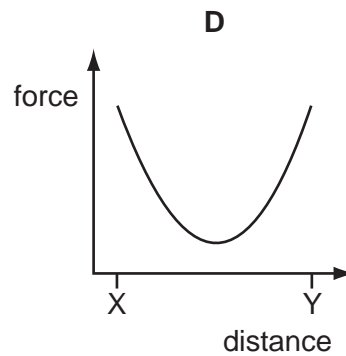
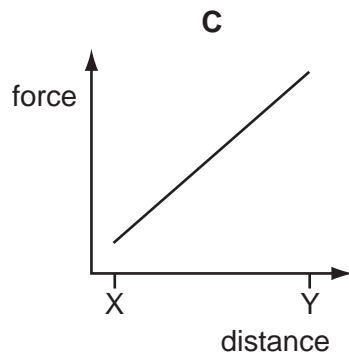
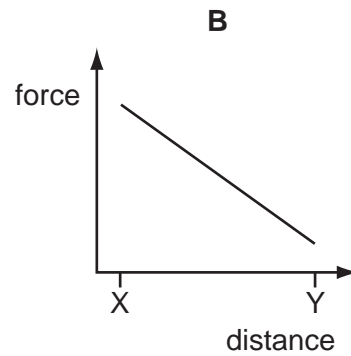
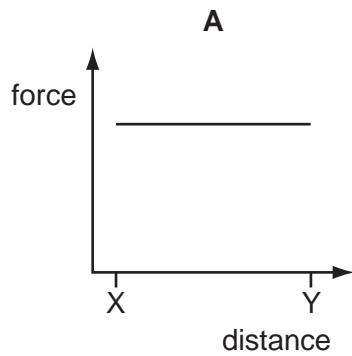

Space for working

- 8 A typical power station, burning a fossil fuel, produces 1200 MW of electrical power. It also produces 2000 MW of heat energy, which is released into the environment.

What is the efficiency of the power station?

- A 37.5% B 40% C 60% D 62.5%

- 9 In the circuit below, the voltmeter reads 21 V.

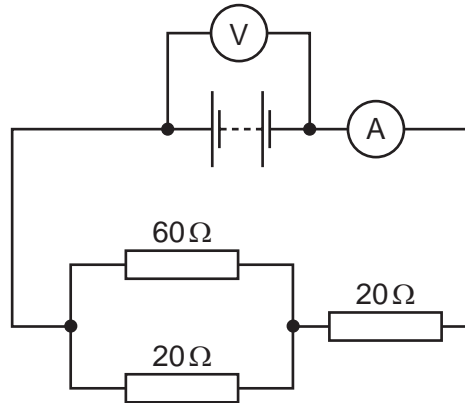

What is the reading on the ammeter?

- A 0.21 A B 0.35 A C 0.60 A D 1.05 A

- 10 The equation below describes a nuclear reaction.

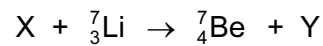

Which row could identify the particles X and Y?

	X	Y
A	electron	proton
B	neutron	proton
C	proton	electron
D	proton	neutron

Space for working

- 11 When chlorine reacts with propane in the presence of ultraviolet radiation, a large number of different products may be formed. Some of these compounds have the molecular formula $C_3H_6Cl_2$.

How many structural isomers are there with the molecular formula $C_3H_6Cl_2$?

- A** 2 **B** 3 **C** 4 **D** 5

- 12 For which equation is the enthalpy change equal to the combined second and third ionisation energies of aluminium?

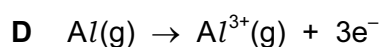
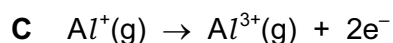
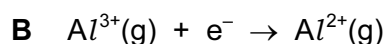
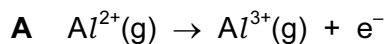

- 13 Chlorine, bromine and iodine are three elements in Group VII.

Which statement comparing these three elements is correct?

A Chlorine gas is almost colourless, bromine vapour is purple.

B Chlorine has the highest boiling point.

C Chlorine is the least volatile.

D Chlorine molecules experience the weakest van der Waals' forces.

Space for working

- 14 The diagram represents the distributions of energies of the particles in a gaseous reaction mixture at two different temperatures, T_1 and T_2 . The activation energy of the uncatalsed reaction is E_a .

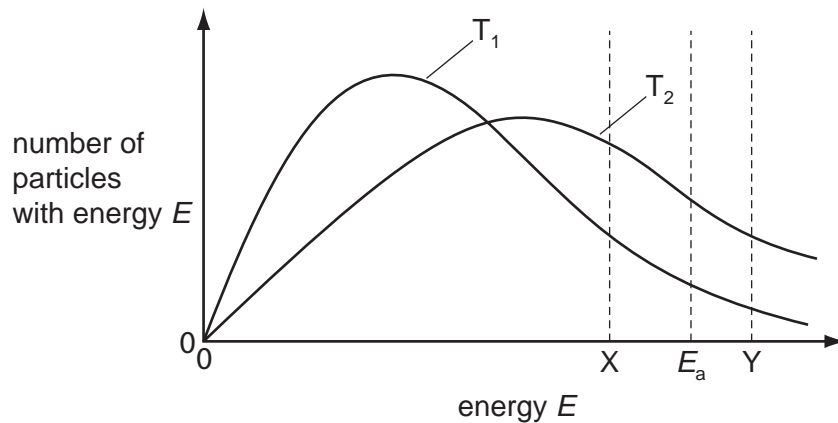

Which statement is correct?

- A In the presence of a catalyst, more particles have energy Y.
 - B Particles with energy Y do **not** have sufficient activation energy.
 - C Temperature T_2 is lower than temperature T_1 .
 - D X indicates a possible activation energy of the reaction in the presence of a catalyst.
- 15 When animal manure is left on a cement floor for some time, a powder, **X**, is formed.

When **X** is heated, brown fumes are observed and a white powder remains. This white residue is sparingly soluble in water.

What is the likely formula of **X**?

- A CaCO_3
- B $\text{Ca}(\text{NO}_3)_2$
- C Na_2CO_3
- D NaNO_3

Space for working

16 The diagram shows the structure of compound **X**.

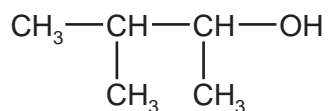

What is the correct systematic name for compound **X**?

- A 1,2-dimethylpropan-1-ol
 - B 2,3-dimethylpropan-3-ol
 - C 2-methylbutan-3-ol
 - D 3-methylbutan-2-ol
- 17 Terpeneol is a natural organic compound that has a pleasant odour similar to lilac and is a common ingredient in perfumes.

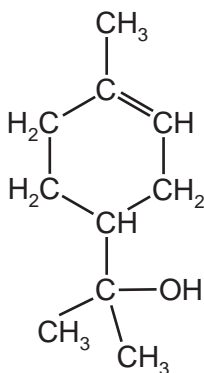

Which statement about this compound is **not** correct?

- A It can be oxidised by acidified $\text{Cr}_2\text{O}_7^{2-}$ ions.
- B It can form hydrogen bonds between its molecules.
- C It has a molecular formula of $\text{C}_{10}\text{H}_{18}\text{O}$.
- D It will decolourise bromine water.

Space for working

18 Compound **X** reacts with NaBH_4 to form compound **Y**.

Compound **X** forms an orange precipitate with 2,4-dinitrophenylhydrazine reagent, but does **not** react with Tollens' reagent.

What could be the structural formula of **Y**?

- A CH_3COCH_3
- B $\text{CH}_3\text{CH}_2\text{CHO}$
- C $\text{CH}_3\text{CH}(\text{OH})\text{CH}_3$
- D $\text{CH}_3\text{CH}_2\text{CH}_2\text{OH}$

19 Complete combustion of 0.105 g of butane, C_4H_{10} , releases enough heat energy to raise the temperature of 100 g of water from 18.0°C to 26.0°C . Assume that no heat energy is lost in this process.

What is the enthalpy change of combustion of butane?

- A $-31.8 \text{ kJ mol}^{-1}$
- B $+31.8 \text{ kJ mol}^{-1}$
- C $-1850 \text{ kJ mol}^{-1}$
- D $+1850 \text{ kJ mol}^{-1}$

20 $\text{CH}_3\text{CHBrCH}_3$ reacts with reagent **P** to give compound **Q**.

Q reacts with $\text{Br}_2(\text{l})$ to give $\text{CH}_3\text{CHBrCH}_2\text{Br}$.

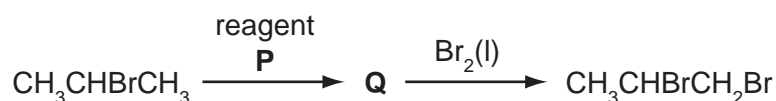

What could be the identity of reagent **P**?

- A $\text{H}_2\text{O}(\text{l})$
- B $\text{H}_2\text{O}(\text{g})$
- C $\text{NaOH}(\text{aq})$
- D NaOH in ethanol

Space for working

Section B

For each of the questions in this section, one or more of the four numbered statements **1** to **4** may be correct.

Decide whether each of the statements is or is not correct (you may find it helpful to put a tick against the statements that you consider to be correct).

The responses **A** to **D** should be selected on the basis of

A	B	C	D
1, 2 and 3 only are correct	1 and 3 only are correct	2 and 4 only are correct	4 only is correct

No other combination of statements is used as a correct response.

21 A satellite orbits a planet at constant speed in a circular orbit.

Which quantities of the satellite remain the same throughout the orbit?

- 1** velocity
- 2** kinetic energy
- 3** momentum
- 4** mass

Space for working

- 22 Cars are designed so that sections collapse when there is a collision. These sections are known as crumple zones.

The diagram shows a car colliding with a wall.

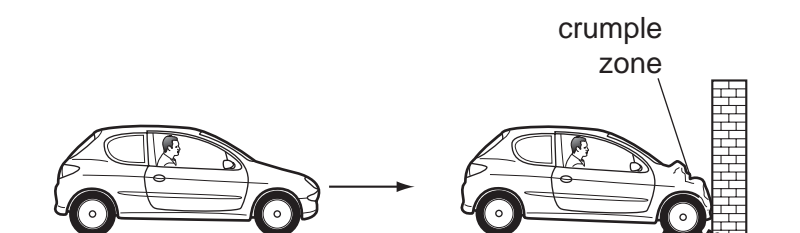

Which statements help to explain why crumple zones tend to reduce injuries in the event of a collision?

- 1 The deceleration of the car is reduced.
 - 2 The time taken for the car to come to rest is reduced.
 - 3 The rate of change of momentum is reduced.
 - 4 The loss in kinetic energy of the car is reduced.
- 23 Two forces of equal magnitude F act on a uniform rigid rod of negligible weight.

In which diagrams is there a couple acting on the rod?

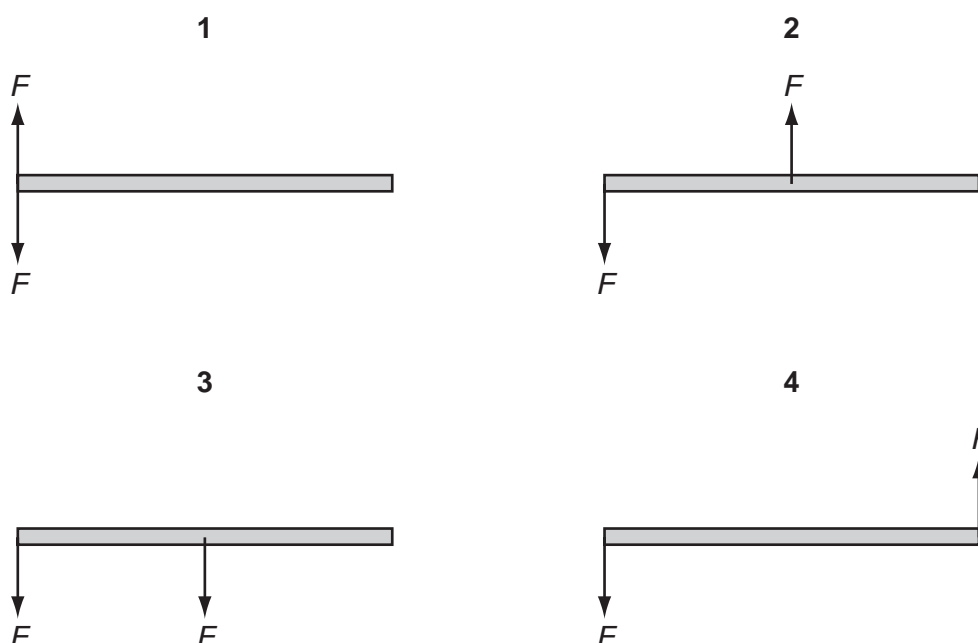

Space for working

The responses **A** to **D** should be selected on the basis of

A	B	C	D
1, 2 and 3 only are correct	1 and 3 only are correct	2 and 4 only are correct	4 only is correct

No other combination of statements is used as a correct response.

24 Which are the correct statements referring to the kinetic theory of gases?

- 1 The temperature of a gas depends on the mean speed of the molecules.
- 2 The molecules in a gas move in random directions.
- 3 The pressure exerted by a gas on its container is caused by the molecules continually colliding with the walls.
- 4 All the molecules in a gas move at the same speed.

25 In which of the following **must** a charge of 1 C pass through a component in an electrical circuit?

- 1 When the potential difference across the component is 1 V and the power supplied to it is 1 W.
- 2 When the potential difference across the component is 1 V and the energy supplied to it is 1 J.
- 3 When the power supplied to the component is 1 W for a time of 1 s.
- 4 When the current in the component is 1 A for a time of 1 s.

Space for working

26 The extraction of aluminium from its ore is an important industrial process.

Which are the correct statements about this process?

- 1 Aluminium ions are reduced.
- 2 Cryolite is added to increase the operating temperature.
- 3 Carbon anodes are used.
- 4 Aluminium is formed at the anode.

27 In which equations is the underlined substance acting as a Brønsted-Lowry acid?

- 1 C₂H₅OH + O²⁻ → C₂H₅O⁻ + OH⁻
- 2 2H₂O + 2Na → 2NaOH + H₂
- 3 H₂CO₃ + CO₃²⁻ → 2HCO₃⁻
- 4 HNO₃ + H₂SO₄ → H₂NO₃⁺ + HSO₄⁻

28 Which particles would form a half-filled p subshell by losing an electron?

- 1 N⁻ 2 O⁺ 3 Cl⁺ 4 S²⁻

Space for working

The responses **A** to **D** should be selected on the basis of

A	B	C	D
1, 2 and 3 only are correct	1 and 3 only are correct	2 and 4 only are correct	4 only is correct

No other combination of statements is used as a correct response.

- 29** A student adds 0.2500 mol of ethanol, $\text{CH}_3\text{CH}_2\text{OH}$, to a warm acidified solution of potassium dichromate(VI). The ethanol is all oxidised to ethanal, CH_3CHO , which is distilled off and collected as it is formed.

Which statements are correct?

- 1** The student uses 11.25 g of ethanol in this reaction.
- 2** Fehling's solution will oxidise both ethanol and ethanal to ethanoic acid.
- 3** 10.76 g of ethanal was collected.
- 4** The shape made by the atoms around each carbon atom in ethanol is tetrahedral.

- 30** Rain is polluted by acidic gases released from a power station. The power station uses coal which has a sulfur content of 1.2% by weight.

Which changes would increase the pH of the rain?

- 1** The power station stops using coal and uses 100% pure methane.
- 2** The power station passes its exhaust gases through calcium hydroxide.
- 3** The power station starts using coal with a sulfur content of 0.2% by weight.
- 4** The power station starts using coal with a sulfur content of 1.5% by weight.

Space for working

Permission to reproduce items where third-party owned material protected by copyright is included has been sought and cleared where possible. Every reasonable effort has been made by the publisher (UCLES) to trace copyright holders, but if any items requiring clearance have unwittingly been included, the publisher will be pleased to make amends at the earliest possible opportunity.

Cambridge International Examinations is part of the Cambridge Assessment Group. Cambridge Assessment is the brand name of University of Cambridge Local Examinations Syndicate (UCLES), which is itself a department of the University of Cambridge.