



UNIVERSITY OF CAMBRIDGE INTERNATIONAL EXAMINATIONS
General Certificate of Education Advanced Subsidiary Level

PHYSICAL SCIENCE

8780/01

Paper 1 Multiple Choice

October/November 2012

40 minutes

Additional Materials: Multiple Choice Answer Sheet
Soft clean eraser
Soft pencil (type B or HB is recommended)
Data Booklet



READ THESE INSTRUCTIONS FIRST

Write in soft pencil.

Do not use staples, paper clips, highlighters, glue or correction fluid.

Write your name, Centre number and candidate number on the Answer Sheet in the spaces provided unless this has been done for you.

There are **thirty** questions on this paper. Answer **all** questions. For each question there are four possible answers **A, B, C** and **D**.

Choose the **one** you consider correct and record your choice in **soft pencil** on the separate Answer Sheet.

Read the instructions on the Answer Sheet very carefully.

Each correct answer will score one mark. A mark will not be deducted for a wrong answer.

Any working should be done in this booklet.

This document consists of **13** printed pages and **3** blank pages.

Relevant Data, Formulae and the Periodic Table are provided in the Data Booklet.

Section A

For each question there are four possible answers, **A**, **B**, **C**, and **D**. Choose the **one** you consider to be correct.

- 1 Micro, nano and pico are three of the prefixes used with SI units.

Which shows them in order from the smallest to the largest?

- A** micro, nano, pico
B micro, pico, nano
C pico, micro, nano
D pico, nano, micro
- 2 A radar station measures the height of a satellite above the Earth's surface. A pulse of microwaves is emitted from the station and is reflected from the satellite when it is overhead. The diagram shows the c.r.o. screen at the radar station.

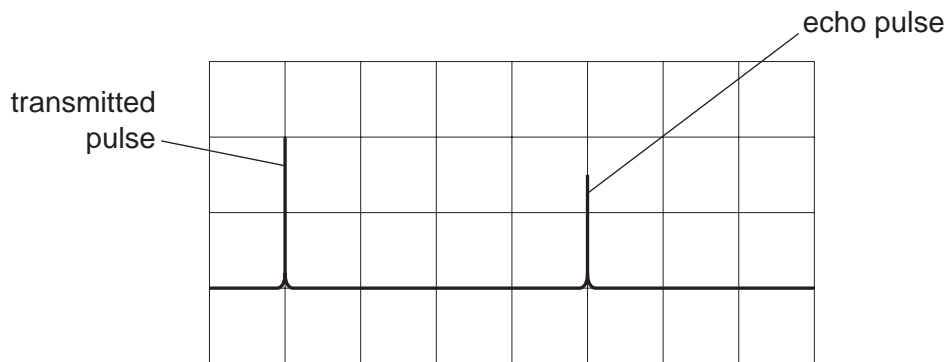

The time base is set to 2 ms div^{-1} .

What is the height of the satellite above the Earth's surface?

- A** $3.0 \times 10^5 \text{ m}$ **B** $6.0 \times 10^5 \text{ m}$ **C** $1.2 \times 10^6 \text{ m}$ **D** $2.4 \times 10^6 \text{ m}$

Space for working

- 3 A box is pulled across a horizontal floor by a force of 60 N. There is a constant frictional force of 40 N. The box moves a distance of 6.0 m.

What is the work done against friction and the change in the kinetic energy of the box?

	work done against friction / J	change in kinetic energy / J
A	240	120
B	240	240
C	360	120
D	360	240

- 4 A vehicle rides on a horizontal track. The vehicle is supported by a magnetic field so that frictional forces are negligible. When the speed of the vehicle is v , its acceleration is a .

The motors deliver a constant power to the vehicle.

What is the acceleration of the vehicle when its speed is $2v$? Assume frictional forces remain negligible.

- A** $\frac{a}{4}$ **B** $\frac{a}{2}$ **C** $\frac{a}{\sqrt{2}}$ **D** a

- 5 The density of ice at 0°C is 920 kg m^{-3} and the density of water at 0°C is 1000 kg m^{-3} .

What is the change in volume when 1.000 kg of ice melts at 0°C ?

- A** -87 cm^3 **B** -80 cm^3 **C** $+80\text{ cm}^3$ **D** $+87\text{ cm}^3$

Space for working

- 6 The diagram represents a plucked stretched string vibrating in a vertical plane.

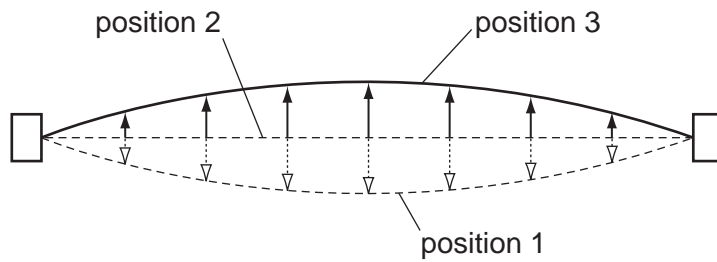

Which changes in the string's energy occur as the string moves from position 2 to position 3?

	kinetic energy	gravitational potential energy	elastic potential energy
A	decreases	decreases	increases
B	decreases	increases	increases
C	increases	decreases	decreases
D	increases	increases	decreases

- 7 The diagram represents the diffraction of water waves in a ripple tank experiment. There is only a small amount of diffraction.

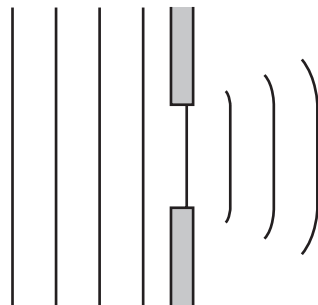

What could be **increased** so that more diffraction occurs?

- A** the amplitude of the waves
- B** the frequency of the waves
- C** the distance between the barriers
- D** the wavelength of the waves

Space for working

- 8 A lamp has a rating of 240 V, 60 W.

What is the rate of flow of electrons through the filament under normal working conditions?

- A $1.6 \times 10^{18} \text{ s}^{-1}$ B $2.5 \times 10^{19} \text{ s}^{-1}$ C $3.8 \times 10^{19} \text{ s}^{-1}$ D $1.5 \times 10^{21} \text{ s}^{-1}$

- 9 What is the electric power when there is a current of 20 mA in a $1.6 \text{ k}\Omega$ resistor?

- A $0.25 \mu\text{W}$ B $12.5 \mu\text{W}$ C 0.64 W D 32 W

- 10 The diagram shows a potential divider circuit with two resistors with resistances of nR and R . The input voltage is V_{in} and the output voltage is V_{out} .

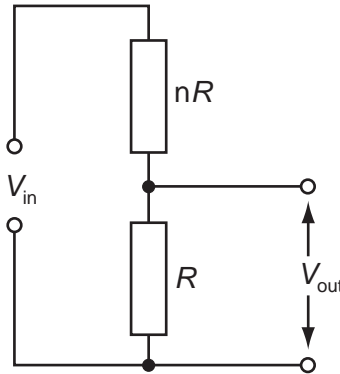

Which expression gives the ratio of $\frac{V_{\text{out}}}{V_{\text{in}}}$?

- A n B $\frac{1}{n}$ C $\frac{1}{(n-1)}$ D $\frac{1}{(n+1)}$

Space for working

- 11 Which compound will **not** reduce an acidified solution of potassium dichromate(VI)?
- A $\text{CH}_3\text{CH}_2\text{CH}(\text{OH})\text{CH}_3$
B HCO_2H
C $\text{CH}_3\text{CH}_2\text{CH}_2\text{OH}$
D $(\text{CH}_3)_2\text{C}(\text{OH})\text{CH}_2\text{CH}_3$
- 12 An aqueous sodium salt gives no precipitate when either aqueous silver nitrate is added, or when aqueous barium chloride is added.

What could be the identity of this sodium salt?

- A NaBr B NaCl C NaNO₃ D Na₂SO₄
- 13 A mixture of two alkene monomers will undergo addition polymerisation.

A mixture of $\text{CH}_2=\text{CHCH}_3$ and $\text{CH}_2=\text{CH}_2$ is polymerised.

Which fragment of a polymer chain **could not** be formed from this mixture?

- A $-\text{CH}_2-\text{CH}_2-\text{CH}_2-\text{CH}_2-\text{CH}_2-\text{CH}_2-\text{CH}(\text{CH}_3)-\text{CH}_2-$
B $-\text{CH}(\text{CH}_3)-\text{CH}_2-\text{CH}(\text{CH}_3)-\text{CH}_2-\text{CH}(\text{CH}_3)-\text{CH}_2-\text{CH}_2-\text{CH}_2-$
C $-\text{CH}(\text{CH}_3)-\text{CH}_2-\text{CH}(\text{CH}_3)-\text{CH}_2-\text{CH}(\text{CH}_3)-\text{CH}_2-\text{CH}(\text{CH}_3)-\text{CH}_2-$
D $-\text{CH}(\text{CH}_3)-\text{CH}(\text{CH}_3)-\text{CH}(\text{CH}_3)-\text{CH}(\text{CH}_3)-\text{CH}_2-\text{CH}_2-\text{CH}_2-\text{CH}_2-$

Space for working

14 A sample of propanone of mass 1.00 g is vaporised at 100 °C and 100 kPa pressure.

What is the volume occupied by this sample of propanone?

[$A_r = \text{C}, 12.0; \text{H}, 1.0; \text{O}, 16.0; R = 8.31 \text{ J mol}^{-1} \text{ K}^{-1}$]

A $6.43 \times 10^{-5} \text{ m}^3$

B $3.91 \times 10^{-4} \text{ m}^3$

C $5.34 \times 10^{-4} \text{ m}^3$

D $5.34 \times 10^{-1} \text{ m}^3$

15 Which has the smallest bond angle?



16 Use the information below to answer the question.

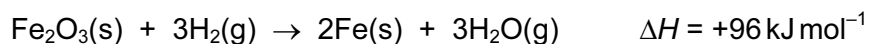

Under the reaction conditions used, the value for the enthalpy change of formation of Fe_2O_3 , ΔH_f , is -822 kJ mol^{-1} .

What is the enthalpy change of formation of steam under these conditions?

A -286 kJ mol^{-1}

B -242 kJ mol^{-1}

C $+242 \text{ kJ mol}^{-1}$

D $+286 \text{ kJ mol}^{-1}$

Space for working

- 17 Calcium oxide is used during the industrial production of metals to remove acidic oxides. It reacts with phosphorus pentoxide to produce calcium phosphate. Phosphate ions are PO_4^{3-} .

When the equation below is balanced, **a**, **b** and **c** are the numbers of moles of individual substances. The product formula has been omitted from the equation.



What are the values of **a**, **b**, and **c**?

	a	b	c
A	1	4	4
B	3	8	4
C	1	6	2
D	1	16	4

- 18 Which is **not** a redox reaction?

- A** $\text{Cu} + 4\text{HNO}_3 \rightarrow \text{Cu}(\text{NO}_3)_2 + 2\text{NO}_2 + 2\text{H}_2\text{O}$
- B** $\text{TiO}_2 + 2\text{Cl}_2 + \text{C} \rightarrow \text{TiCl}_4 + \text{CO}_2$
- C** $\text{SO}_4^{2-} + 2\text{I}^- + 4\text{H}^+ \rightarrow \text{SO}_2 + \text{I}_2 + 2\text{H}_2\text{O}$
- D** $\text{CuO} + 2\text{HCl} \rightarrow \text{CuCl}_2 + \text{H}_2\text{O}$

Space for working

- 19 The following equations represent two natural processes for nitrogen fixation, the process in which atmospheric nitrogen is converted to usable nitrogen for plants.

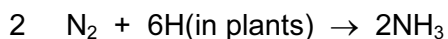
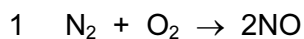

How will each process change the soil pH?

	process 1	process 2
A	higher pH	higher pH
B	higher pH	lower pH
C	lower pH	higher pH
D	lower pH	lower pH

- 20 A carnivorous plant, the Venus flytrap, secretes a liquid over its trapped prey to dissolve it.

A compound, **X**, can be obtained from this liquid.

X reacts with sodium to produce a colourless gas but does not change the colour of acidified potassium dichromate.

Which of the following is **X**?

- A** $\text{CH}_3\text{CHOHCOOH}$
- B** $\text{CH}_3\text{CH}_2\text{COOH}$
- C** CH_3OH
- D** CH_2O

Space for working

Section B

For each of the questions in this section, one or more of the four numbered statements **1** to **4** may be correct.

Decide whether each of the statements is or is not correct (you may find it helpful to put a tick against the statements that you consider to be correct).

The responses **A** to **D** should be selected on the basis of

A	B	C	D
1, 2 and 3 only are correct	1 and 3 only are correct	2 and 4 only are correct	4 only is correct

No other combination of statements is used as a correct response.

- 21** Two objects of equal mass move towards each other in opposite directions along the same straight line. The two objects have the same speed, v . The objects collide; no other forces act on them.

Which outcomes are possible?

- 1** They rebound and move away from each other, both with speed v .
- 2** They rebound and move away from each other, with equal speeds less than v .
- 3** They join and become stationary.
- 4** They join and move together with a speed v .

Space for working

22 Three coplanar forces act at a point.

In which vector diagrams are the forces in equilibrium?

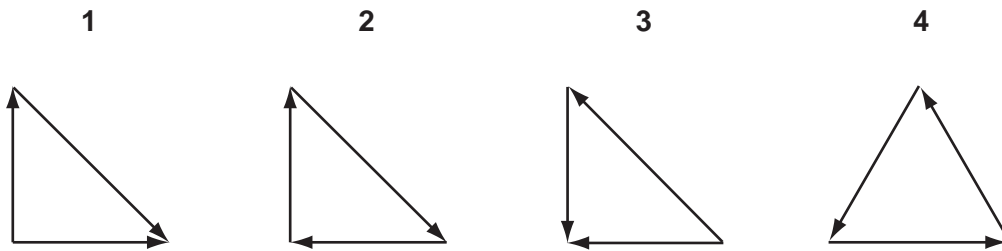

23 A diver is exploring the seabed.

Which of these statements are correct?

- 1 The water pressure on the diver depends on the density of the sea water.
- 2 The water pressure is equal on all parts of the diver.
- 3 The water pressure on the diver increases with depth.
- 4 The water pressure on the diver depends on the diver's mass.

24 Which statements describe conditions that are **necessary** for waves **in the same medium** to be coherent?

- 1 The waves are exactly in phase.
- 2 The waves have equal frequency.
- 3 The waves have equal amplitude.
- 4 The waves have equal wavelength.

Space for working

The responses **A** to **D** should be selected on the basis of

A	B	C	D
1, 2 and 3 only are correct	1 and 3 only are correct	2 and 4 only are correct	4 only is correct

No other combination of statements is used as a correct response.

25 Which of the following are isotopes of A_ZX ?

- 1** ${}^A_{Z+1}X$ **2** ${}^{A+1}_{Z-1}X$ **3** ${}^A_{Z-1}X$ **4** ${}^{A-1}_ZX$

26 Which atoms are able to form four single covalent bonds with other atoms to produce molecules or ions?

- 1** Al **2** N **3** C **4** Cl

27 In which series does the oxidation number of the named atom increase **at each stage** from left to right?

- 1** chlorine: $Cl^- \rightarrow ClO^- \rightarrow ClO_3^-$
2 chromium: $Cr^{3+} \rightarrow CrO_4^{2-} \rightarrow Cr_2O_7^{2-}$
3 manganese: $MnO_2 \rightarrow MnO_4^{2-} \rightarrow MnO_4^-$
4 vanadium: $VO_2^+ \rightarrow VO^{2+} \rightarrow V^{3+}$

28 Which atoms, when uncombined, have only two unpaired electrons?

- 1** C **2** Mg **3** S **4** N

Space for working

- 29 When a mixture of ethyl ethanoate and water is left to stand, an equilibrium mixture is formed as shown in the following equation.

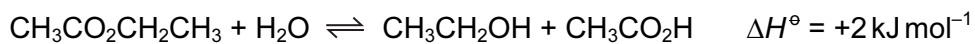

Which changes will cause the amount of $\text{CH}_3\text{CH}_2\text{OH}$ in the mixture to increase?

- 1 raising the temperature
- 2 adding ethanoic acid
- 3 adding water
- 4 adding a catalyst

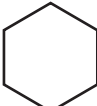
- 30 The diagram shows a reaction scheme. The symbol  represents cyclohexane.

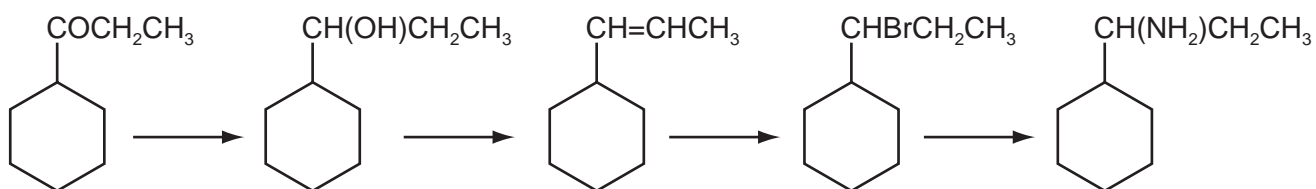

Which types of reaction are **not** involved in the sequence?

- 1 substitution
- 2 dehydration
- 3 reduction
- 4 hydrolysis

Space for working

BLANK PAGE

Permission to reproduce items where third-party owned material protected by copyright is included has been sought and cleared where possible. Every reasonable effort has been made by the publisher (UCLES) to trace copyright holders, but if any items requiring clearance have unwittingly been included, the publisher will be pleased to make amends at the earliest possible opportunity.

University of Cambridge International Examinations is part of the Cambridge Assessment Group. Cambridge Assessment is the brand name of University of Cambridge Local Examinations Syndicate (UCLES), which is itself a department of the University of Cambridge.