

**MARK SCHEME for the May/June 2010 question paper
for the guidance of teachers**

9707 BUSINESS STUDIES

9707/32 Paper 32 (Case Study), maximum raw mark 100

This mark scheme is published as an aid to teachers and candidates, to indicate the requirements of the examination. It shows the basis on which Examiners were instructed to award marks. It does not indicate the details of the discussions that took place at an Examiners' meeting before marking began, which would have considered the acceptability of alternative answers.

Mark schemes must be read in conjunction with the question papers and the report on the examination.

- CIE will not enter into discussions or correspondence in connection with these mark schemes.

CIE is publishing the mark schemes for the May/June 2010 question papers for most IGCSE, GCE Advanced Level and Advanced Subsidiary Level syllabuses and some Ordinary Level syllabuses.

Page 2	Mark Scheme: Teachers' version	Syllabus	Paper
	GCE A LEVEL – May/June 2010	9707	32

1 Analyse two limitations of the market research Ahmed conducted before setting up the business. [8]

	Knowledge	Application	Analysis
Level 2	2 marks Two limitations or one plus definition	2 marks Both applied to case	4–3 marks Both limitations explained
Level 1	1 mark Definition or one limitation	1 mark One limitation application	2–1 marks One limitation explained

Definition: Research into market needs, trends, competitors.

Limitations:

- Questionnaire – poor response rate which reduces accuracy.
- Only two schools – sample may have been biased.
- No details of sampling given but if just handed out “at random” this would not necessarily lead to a representative sample.
- Only a few questions asked – other information might have been useful too such as which magazines do you buy and why? This would have helped him to assess the articles to include etc.
- No qualitative data – this would have helped to explain why consumers buy what they do.
- Alternative methods can only be credited if they are used to illustrate limitations of method(s) used.

2 Discuss which of the two approaches to managing the workforce in the printing factory should be adopted by the company in response to the problems explained on lines 64–71 [16]

	Knowledge	Application	Analysis	Evaluation
Level 2	3–2 marks Good understanding shown of HR management	3–2 marks Well applied to case	4–3 marks Good use of BST theory or logical reasoning	6–4 marks Judgement shown within answer and conclusion
Level 1	1 mark Some understanding of HRM shown	1 mark Some application	2–1 marks Some use of theory or logical reasoning	3–1 marks Some judgement shown

Examiners note: L1 Analysis and Evaluation for no specific use of Table 1.

- Candidates may define HRM even though this term is not in the question.
- Application marks may be awarded by making reference to the problems referred to in lines 64–71 but without any further contextual points.
- Ahmed – “hard” approach with the aim of minimising costs.
- Piecework – may help to increase productivity – BUT quality is important to the printed magazine too.
- Taylor approach – may lead to the “best way” being used BUT how motivated will the workers be?
- Clear instruction given – avoids confusion BUT suggests a lack of 2-way communication and a lack of job enrichment.
- Malika – “soft” approach with the aim of realising the full potential of the workforce.
- Salary and bonuses – may help to reduce “them and us” culture BUT need to consider the cost of this approach. and will retained profits rise or fall as a consequence?
- Job enrichment and quality circles – should prove to be “motivating” factors BUT the management attitude may need to change and staff training may be needed.
- Overall: As there seem to be a number of changes taking place and the industry seems to be becoming more technologically based, perhaps Malka’s approach is preferred – the company will want well motivated and flexible staff to be retained in the business.

Page 3	Mark Scheme: Teachers' version	Syllabus	Paper
	GCE A LEVEL – May/June 2010	9707	32

3 Evaluate the pricing methods that the company could use if the magazine for 20–35 years olds is launched. [14]

	Knowledge	Application	Analysis	Evaluation
Level 2	3–2 marks Good understanding of pricing methods shown	3–2 marks Well applied to case	4–3 marks Good use of BST theory or logical reasoning	4–3 marks Judgement shown within answer and conclusion
Level 1	1 mark Some understanding of pricing method(s) shown	1 mark Some application	2–1 marks Some use of theory or logical reasoning	2–1 marks Some judgement shown

- Pricing decisions are important – need to cover costs, they can influence the quality image of the product, they need to consider competitors' prices etc.
- Penetration or skimming pricing. Magazine for older people has less competition – skimming might be appropriate. This age range does have more disposable income. Penetration could be used if the economic data suggests that disposable incomes might fall in future.
- Full cost pricing – average total cost of new magazine plus profit margin. Ensures that profit is made on every magazine sold (assuming break-even is reached) BUT the case suggests that there are more magazines aimed at this segment than for older readers. Will this price be uncompetitive though?
- Contribution pricing – based on average variable costs plus a contribution. Fixed costs are not allocated directly to the product. Allows more flexibility of pricing in a competitive market, BUT if the fixed costs of setting up the new magazine (more salaried staff and machinery?) are high will this pricing method cover these costs?
- Allow other pricing methods/strategies to be considered too if discussed in context.
- Overall: The final pricing method may depend on the objectives the business has for this new product and the degree of competition in this market segment. Candidates may make some assumptions about these factors to support their recommendation.

4 (a) Using the data in Appendix C, calculate:

(i) Acid test ratio [3]

Acid test ratio = 0.58 = 3 marks
 Correct data but mathematical error = 2 marks
 Liquid assets/current liabilities = 1 mark

(ii) Gearing ratio. [3]

Gearing ratio = 49% = 3 marks
 Correct data but mathematical error = 2 marks
 Long term liabilities/capital employed x 100 = 1 mark
 Accept other versions of gearing ratio:
 LTL/Share capital = 77/80 = 96.25%
 LTL/Share capital + Ret. Profits = 77/90 = 85.5%

Page 4	Mark Scheme: Teachers' version	Syllabus	Paper
	GCE A LEVEL – May/June 2010	9707	32

- (b) Using your results to (a) and other data, recommend which sources of capital the company should use to finance the \$30000 set up costs of the magazine for 56–70 year olds. [10]

Knowledge	Application	Analysis	Evaluation
2 marks Good understanding of results or other data shown	2 marks Well applied to case	3 marks Good use of BST theory or logical reasoning	3 marks Judgement shown within answer and conclusion
1 mark Some understanding of results/data shown	1 mark Some application	2–1 marks Some use of theory or logical reasoning	2–1 marks Some judgement shown

- Long-term capital likely to be needed as these seem to be long-term projects.
- Acid test is acceptable but it suggests that there are no liquid assets available in the business to finance this project – BUT cash figure is not given.
- Gearing is high – BUT whether this is a risk or not depends on interest rates and the company's profit prospects. If all capital was raised from debt then gearing ratio becomes 54.3% (107/197). If the new magazine quickly earns profits the debt could be repaid, reducing gearing and interest costs. Accept re-working of other gearing ratios.
- Issue of shares – but A and M may not want to lose more control – if Novak put more in then they would effectively lose control.
- Other long-term methods could be discussed.
- Overall: Debt may be a viable option unless A and M can purchase more share capital themselves which might be the better option. Other conclusions possible.

- 5 (a) Use the decision tree (Appendix B) to calculate the expected monetary values of the two options. [10]

Ready Reckoner:

Result \$000	Mark	Explanation
60 and 56	10	Correct answers for both options
60 or 56	9	One correct answer
40 and 33.6	8	Not included results from nodes 2 and 3
40 or 33.6	7	Only 1 result obtained by not including results from nodes 2 and 3
80 and 61.6	8	Adding the results of the two separate decisions together
80 or 61.6	7	Only 1 result obtained by adding results together
40 and 28.6	6	Only calculating up to nodes 2 and 3
40 or 28.6	5	Only calculating up to either node 2 or 3

Weak understanding shown (e.g. some use made of probabilities x payoffs) = 4–3 marks.
Some understanding shown = 2–1 marks

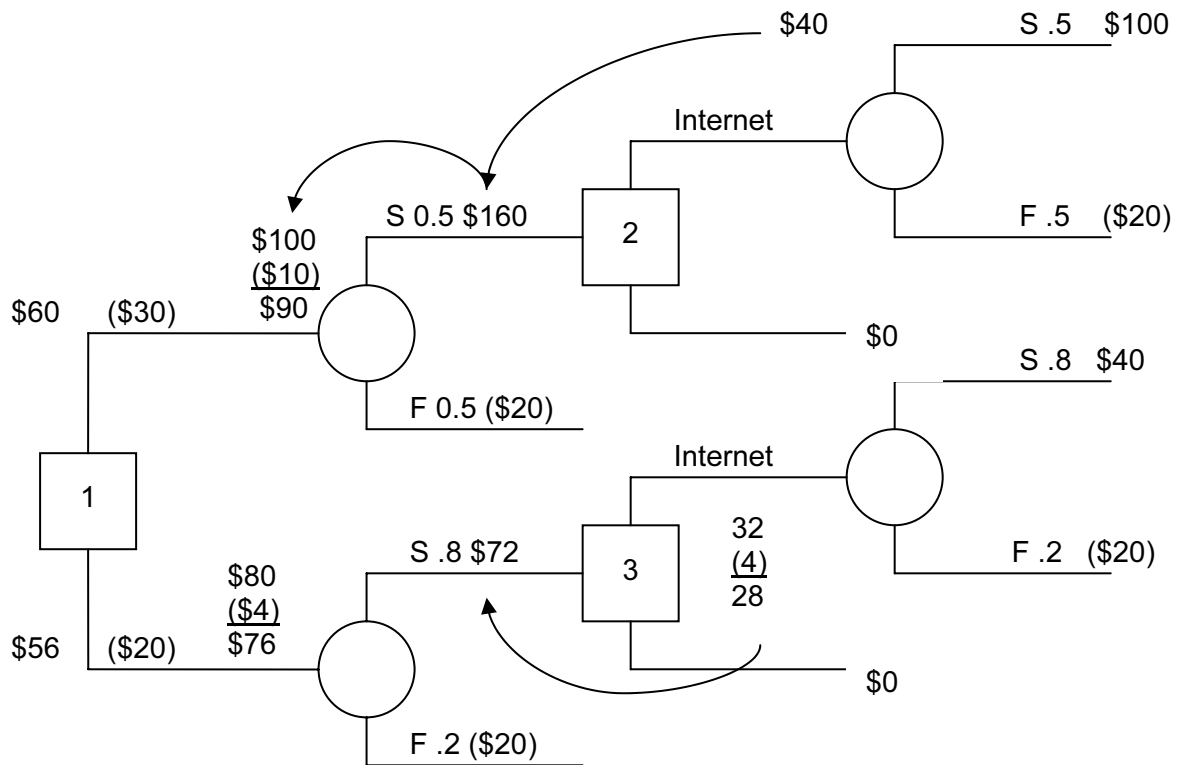

(b) For which age range would you recommend TeenPrint to launch the new magazine? Use your results to (a) and any other information to support your recommendation. [16]

	Knowledge	Application	Analysis	Evaluation
Level 2	3–2 marks Good understanding shown of issues shown	3–2 marks Well applied to case	4–3 marks Good use of BSt theory or logical reasoning	6–4 marks Judgement shown within answer and conclusion
Level 1	1 mark Some understanding of issues shown	1 mark Some application	2–1 marks Some use of theory or logical reasoning	3–1 marks Some judgement shown

- Use of results in a) BUT how reliable is this technique? So many assumptions and forecasts are required. Have the results been biased in any way? Have other techniques been used e.g. investment appraisal?
- Writers seem to be closer in age to 20–35 year segment – this could make it easier to decide what articles to include BUT there seems to be less competition in the older age market segment.
- Data in Appendix A – this appears to be more favourable for the age 56–70 market BUT inflation is forecast to rise (App D) and this could reduce pensioners' real income. Much of this data is forecast – how reliable is it?
- Other data would have been useful: number of other magazines in these segments; prices charged, market share of them etc.
- Overall: Candidates can decide on either but for L2 evaluation there must be a clear recommendation. Perhaps more research should be undertaken – quantitative and qualitative – before such a major decision is taken?

Page 6	Mark Scheme: Teachers' version	Syllabus	Paper
	GCE A LEVEL – May/June 2010	9707	32

Both question 6 and 7 should be marked according to this grid:

	Knowledge	Application	Analysis	Evaluation
Level 3				10–7 marks Good judgement shown in answer and conclusion
Level 2	3–2 marks Good understanding of issues shown	3–2 marks Well applied to case	4–3 marks Good use of BST theory or logical reasoning	6–4 marks Good judgement shown either within answer or conclusion
Level 1	1 mark Some understanding of issues shown	1 mark Some application	2–1 marks Some use of theory or logical reasoning	3–1 marks Some judgement shown

6 Evaluate the extent to which external economic change will be the major factor determining future profits of the TeenPrint company? Refer to Appendix D and other information in your answer. [20]

- Profits are earned after deducting all costs from revenue.
- Retained profits will also depend on corporation tax – no data on this.
- Economic factors could include:
- Impact on demand e.g. GDP changes – is this likely to be an income elastic product?
- Inflation – will costs rise for the business and will they be able to increase prices at the same rate – depends on PED? BUT what about cost inflation for this particular business – might be different from data given.
- Interest rate forecast to rise – could raise business costs, especially if they use debt for either option.
- Exchange rate – is paper imported? If so, this forecast depreciation will raise import costs.
- Candidates could prioritise this data and suggest which is likely to be the most important. How reliable are the forecasts?
- BUT – other factors will be important too. How the production/people problems are managed. The management skills of A and M as the business expands. Technological changes that might develop quicker than the company's ability to benefit from them. Any other reasonable answer.
- Overall: Economic factors important – but by no means the only or the most important factors affecting future profits. Overall conclusion is needed for L3 evaluation.

Page 7	Mark Scheme: Teachers' version	Syllabus	Paper
	GCE A LEVEL – May/June 2010	9707	32

7 Would you advise the company to adopt lean production methods for the printed magazines? Justify your answer. [20]

- Explanation of lean production: The operations philosophy that aims to minimise waste of all operational resources in the production process.
- JIT, kaizen, TQM, simultaneous engineering – other similar approaches may be suggested.
- Candidates need to analyse how these approaches – or some of them – might benefit TeenPrint with the problems that it has. The analysis might examine the impact on profit of the reduced waste/improved quality/quicker response times etc.
- The benefits to this company could be:
 - Lower stock levels with JIT – BUT how reliable are paper and other suppliers?
 - Quicker new product development times and more flexible production systems – BUT does the business have the capital and the management experience to manage the introduction of the equipment and processes needed?
 - Better motivated staff as they will be involved more in waste reduction and quality improvements – scope for their suggestions. BUT will they be involved in the change process and will they be trained in the new processes and practices?
- Overall: How committed is this business to printed magazine production? Could the company justify the capital and the time needed to be invested in adopting these approaches? How able are A and M to manage this process? Overall recommendation is needed for L3 evaluation.