



UNIVERSITY OF CAMBRIDGE INTERNATIONAL EXAMINATIONS  
General Certificate of Education Advanced Level

CANDIDATE  
NAME

CENTRE  
NUMBER

--	--	--	--	--

CANDIDATE  
NUMBER

--	--	--	--



**BIOLOGY**

**9700/53**

Paper 5 Planning, Analysis and Evaluation

**May/June 2012**

**1 hour 15 minutes**

Candidates answer on the Question Paper.

No Additional Materials are required.

**READ THESE INSTRUCTIONS FIRST**

Write your Centre number, candidate number and name on all the work you hand in.

Write in dark blue or black ink.

You may use a soft pencil for any diagrams, graphs or rough working.

Do not use staples, paper clips, highlighters, glue or correction fluid.

**DO NOT WRITE IN ANY BARCODES.**

Answer **both** questions.

At the end of the examination, fasten all your work securely together.

The number of marks is given in brackets [ ] at the end of each question or part question.

For Examiner's Use	
1	
2	
<b>Total</b>	

This document consists of 7 printed pages and 1 blank page.



- 1 A student investigated the effect of different growth media on the germination and growth of pollen.

The growth media tested are shown in Table 1.1.

**Table 1.1**

component	concentration of components in each growth medium		
	medium A	medium B	medium C
sucrose solution / %	10	10	10
boric acid / $\text{mg dm}^{-3}$	0	100	100
calcium nitrate / $\text{mg dm}^{-3}$	0	300	300
magnesium sulfate / $\text{mg dm}^{-3}$	0	0	200
potassium nitrate / $\text{mg dm}^{-3}$	0	0	100

Fig. 1.1 shows the apparatus used by the student in this investigation.

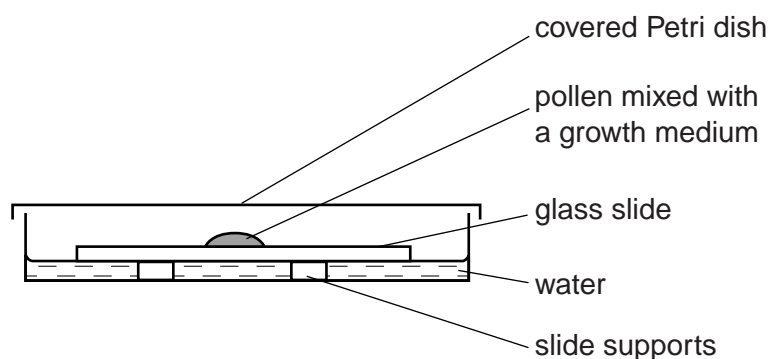

**Fig. 1.1**

The student carried out the following procedure when investigating each growth medium, **A**, **B** and **C**:

- pollen from a mature anther of a flower was removed with a paint brush
- the pollen was mixed with two drops of the growth medium on a slide
- the slide was placed in the Petri dish as shown in Fig. 1.1
- the apparatus was kept at room temperature
- every 10 minutes the slide was removed and the pollen observed using a light microscope
- the percentage of the pollen germinated was estimated
- the lengths of the 10 longest pollen tubes in a field of view were measured
- the mean pollen tube length was calculated.

The results of the three investigations are shown in Table 1.2.

For  
Examiner's  
Use

**Table 1.2**

	mean length of ten longest pollen tubes / $\mu\text{m}$						
time / min	10	20	30	40	50	60	70
medium A	23.9	48.5	72.4	97.6	128.2	156.0	180.0
medium B	27.6	58.4	89.9	121.7	154.8	186.8	219.2
medium C	38.2	76.1	112.6	150.6	188.5	226.5	264.7
	percentage germination						
medium A	5	18	26	38	51	55	57
medium B	8	12	22	31	46	52	61
medium C	3	8	18	28	36	48	56

(a) Identify the independent variable and the **two** dependent variables.

*independent* .....

*dependent* .....

..... [2]

(b) (i) Describe how the student could have measured the length of the pollen tubes using a microscope.

.....  
 .....  
 .....  
 .....  
 .....  
 .....  
 ..... [3]

(ii) Suggest why the percentage germination was calculated.

.....  
 ..... [1]

- (c) The student carried out *t*-tests on the results to compare the lengths of the pollen tubes when grown in different media.

To carry out a *t*-test the number in the sample must be counted. It is also necessary to carry out two calculations from the data.

- (i) State the **two** calculations that must be carried out in order to complete a *t*-test.

.....  
..... [1]

- (ii) State why the student decided to use 18 degrees of freedom in each of the *t*-test calculations.

.....  
..... [1]

The student carried out a number of *t*-tests to find out if, after 70 minutes, the difference in mean pollen tube length is significant:

1. between medium **A** and medium **B**      ***t* = 2.50**
2. between medium **A** and medium **C**      ***t* = 3.56**
3. between medium **B** and medium **C**      ***t* = 1.94**

Table 1.3 shows the critical values for the *t*-test.

**Table 1.3**

<b>degrees of freedom</b>	10	12	14	16	18	20	22	24	26	28	30	40	50	60
<b>probability 0.05</b>	2.23	2.18	2.14	2.12	2.10	2.09	2.07	2.06	2.06	2.05	2.04	2.02	2.01	2.00
<b>probability 0.01</b>	3.17	3.06	2.98	2.92	2.88	2.85	2.82	2.80	2.78	2.76	2.75	2.70	2.68	2.66

- (iii) State what conclusions can be drawn about the significance of the differences in mean lengths from the three values of ***t*** given above.

.....  
.....  
.....  
.....  
.....  
..... [3]

(d) From the results in Table 1.2 and the *t*-tests the student concluded that:

- calcium has no effect on the germination of pollen grains but increases the growth rate of pollen tubes
- sucrose is needed for pollen tube germination but has no effect on the growth rate of the pollen tube.

(i) With reference to Table 1.2 state the evidence that supports these conclusions and the evidence that does **not** support these conclusions.

*evidence that supports these conclusions* .....

.....

.....

.....

.....

.....

.....

*evidence that does **not** support these conclusions* .....

.....

.....

.....

.....

.....

.....

..... [4]

(ii) Outline a further investigation that the student might carry out to provide more support for the conclusions about the role of sucrose in the germination of pollen and in the growth of pollen tubes.

.....

.....

.....

..... [2]

(iii) Predict the results of this investigation if the student's conclusion about the effects of sucrose is correct.

.....

.....

..... [2]

[Total: 19]

- 2 In mammals, digested food is absorbed by active transport and diffusion. In an investigation into the absorption of sugars a short piece of intestine was turned inside out, so that the absorptive surface was on the outside. The ends of the intestine were tied to form a bag containing oxygenated buffer solution.

The apparatus used is shown in Fig. 2.1.

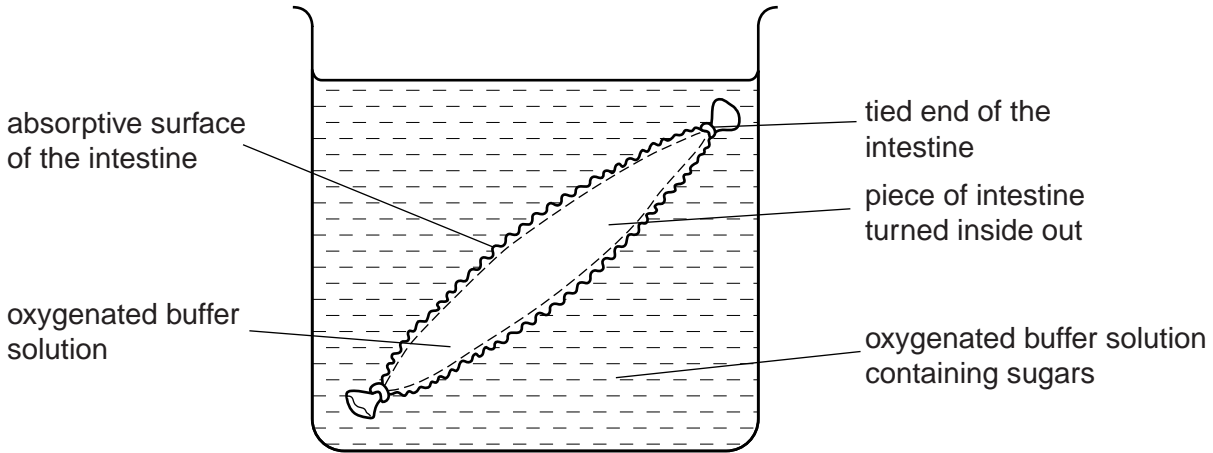

Fig. 2.1

- (a) (i) Outline a method that could have been used to oxygenate the buffer solution.

.....

.....

.....

.....

..... [2]

- (ii) Identify **one** important variable, other than those shown in Fig. 2.1, that should be standardised in this investigation.

..... [1]

- (b) Substances which are absorbed by the intestine collect in the centre of the bag. Samples from the contents of the bag can be removed for analysis.

The absorption of glucose was investigated using untreated pieces of intestine and pieces of intestine that had been treated with a respiratory inhibitor. The investigation was then repeated using fructose.

Table 2.1 shows the results of this investigation.



**BLANK PAGE**

---

Permission to reproduce items where third-party owned material protected by copyright is included has been sought and cleared where possible. Every reasonable effort has been made by the publisher (UCLES) to trace copyright holders, but if any items requiring clearance have unwittingly been included, the publisher will be pleased to make amends at the earliest possible opportunity.

University of Cambridge International Examinations is part of the Cambridge Assessment Group. Cambridge Assessment is the brand name of University of Cambridge Local Examinations Syndicate (UCLES), which is itself a department of the University of Cambridge.